

Transmission and Multiplexing (TM); Spectral Management on Metallic Access Networks; Part 1: Definitions and Signal Library

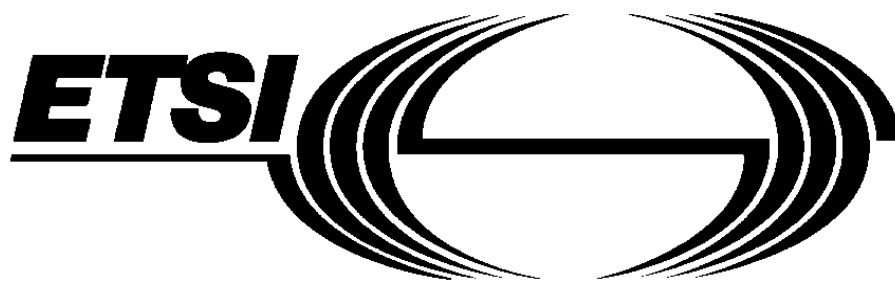

Work Item Reference DTS/TM-06016
Permanent Document **TM6(99)07**
Filename 990p07a2*
Date june 7, 2000

Rapporteur/Editor **Rob F.M. van den Brink**
KPN Research
PO Box 421
2260 AK Leidschendam
The Netherlands

tel: +31 70 3325389
fax: +31 70 3326477
email: R.F.M.vandenBrink@research.kpn.com

Reference

DTS/TM-06016

Keywords

unbundling, local loop, MDF Access, spectral management, xDSL, transmission

ETSI

Postal address

F-06921 Sophia Antipolis Cedex - FRANCE

Office address

650 Route des Lucioles - Sophia Antipolis
Valbonne - FRANCE
Tel.: +33 4 92 94 42 00 Fax: +33 4 93 65 47 16
Siret N° 348 623 562 00017 - NAF 742 C
Association à but non lucratif enregistrée à la
Sous-Préfecture de Grasse (06) N° 7803/88

Internet

secretariat@etsi.fr
<http://www.etsi.org>

Copyright Notification

Reproduction is only permitted for the purpose of standardization work undertaken within ETSI.
The copyright and the foregoing restrictions extend to reproduction in all media.

© European Telecommunications Standards Institute 2000.
All rights reserved.

Contents

1.	Scope	6
2.	Definition of terminology, symbols and abbreviations	6
2.1.	Terminology	6
2.2.	Abbreviations	7
3.	The technical purpose of Spectral Management	8
3.1.	Bounding spectral pollution	8
3.2.	The Individual Components of Spectral Pollution	9
4.	Reference model of the local loop wiring	10
4.1.	The concept of a Port, the interface the Local Loop Wiring	10
4.2.	Bounding Spectral Pollution by limiting signals at the Ports	10
4.3.	Reference model	11
5.	Minimum set of characteristics for signal descriptions	12
6.	Cluster 1 Signals (voice band)	13
6.1.	"POTS" Signals (voice band lines 300 - 3400Hz)	13
6.1.1.	Total signal voltage	13
6.1.2.	Peak amplitude	13
6.1.3.	Narrow-band signal voltage	13
6.1.4.	Unbalance about earth	15
6.1.5.	Feeding Power (from the LT-port)	16
6.1.6.	Reference impedance Z_R	17
6.1.7.	Ringling signal	17
6.1.8.	Metering signals	17
7.	Cluster 2 Signals (semi broad band)	18
7.1.	"ISDN.2B1Q" Signals	18
7.1.1.	Total signal power	18
7.1.2.	Peak amplitude	18
7.1.3.	Narrow-band signal power	18
7.1.4.	Unbalance about earth	19
7.1.5.	Feeding Power (from the LT-port)	20
7.2.	"ISDN.MMS.43" Signals	21
7.2.1.	Total signal power	21
7.2.2.	Peak amplitude	21
7.2.3.	Narrow-band signal power	21
7.2.4.	Unbalance about earth	22
7.2.5.	Feeding Power (from the LT-port)	23
8.	Cluster 3 Signals (symmetrical broad band)	25
8.1.	"HDSL.2B1Q/3" Signals (392 kbaud leased lines)	25
8.1.1.	Total signal power	25
8.1.2.	Peak amplitude	25
8.1.3.	Narrow-band signal power	25
8.1.4.	Unbalance about earth	26
8.1.5.	Feeding Power (from the LT-port)	27
8.2.	"HDSL.2B1Q/2" Signals (584 kbaud leased lines)	28
8.2.1.	Total signal power	28
8.2.2.	Peak amplitude	28
8.2.3.	Narrow-band signal power	28
8.2.4.	Unbalance about earth	29
8.2.5.	Feeding Power (from the LT-port)	30
8.3.	"HDSL.2B1Q/1" Signals (1160 kbaud leased lines)	31
8.3.1.	Total signal power	31
8.3.2.	Peak amplitude	31

8.3.3.	Narrow-band signal power.....	31
8.3.4.	Unbalance about earth	32
8.3.5.	Feeding Power (from the LT-port).....	33
8.4.	"HDSL.CAP/2" Signals	34
8.4.1.	Total signal power.....	34
8.4.2.	Peak amplitude	34
8.4.3.	Narrow-band signal power (NBSP).....	34
8.4.4.	Unbalance about earth	35
8.4.5.	Feeding Power (from the LT-port).....	36
8.5.	"SDSL" Signals	37
8.6.	"Proprietary.SymDSL.CAP.A::Fn" Signals	37
8.6.1.	Total signal power.....	38
8.6.2.	Peak amplitude	38
8.6.3.	Narrow-band signal power (NBSP).....	38
8.6.4.	Unbalance about earth	39
8.7.	"Proprietary.SymDSL.CAP.B::Fn" Signals	40
8.7.1.	Total signal power.....	41
8.7.2.	Peak amplitude	41
8.7.3.	Narrow-band signal power (NBSP).....	41
8.7.4.	Unbalance about earth	42
8.8.	"Proprietary.SymDSL.PAM::Fn" Signals	44
8.8.1.	Total Signal Power.....	44
8.8.2.	Peak amplitude	45
8.8.3.	Narrow-band signal power (NBSP).....	45
8.8.4.	Unbalance about earth	46
8.8.5.	Feeding Power (from the LT-port).....	47
8.9.	"Proprietary.SymDSL.2B1Q::Fn" Signals	48
8.9.1.	Total Signal Power.....	48
8.9.2.	Peak amplitude	48
8.9.3.	Narrow-band signal power (NBSP).....	49
8.9.4.	Unbalance about earth	50
8.9.5.	Feeding Power (from the LT-port).....	51
8.10.	"Proprietary.PCM.HDB3.2M.SR" Signals	51
8.10.1.	Total signal power.....	52
8.10.2.	Peak amplitude	52
8.10.3.	Narrow-band signal power.....	52
8.10.4.	Unbalance about earth	53
8.10.5.	Feeding Power (from the LT-port).....	54
9.	Cluster 4 Signals (asymmetrical broad band)	55
9.1.	"ADSL over POTS" Signals	55
9.1.1.	Total signal power (downstream only).....	55
9.1.2.	Total signal power (upstream only).....	55
9.1.3.	Peak amplitude (upstream and downstream).....	55
9.1.4.	Narrow-band signal power (downstream only).....	56
9.1.5.	Narrow-band signal power (upstream only).....	57
9.1.6.	Unbalance about earth (upstream and downstream)	58
9.2.	"ADSL over ISDN" Signals	60
9.2.1.	Total signal power (downstream only).....	60
9.2.2.	Total signal power (upstream only).....	60
9.2.3.	Peak amplitude (upstream and downstream).....	60
9.2.4.	Narrow-band signal power (downstream only).....	60
9.2.5.	Narrow-band signal power (upstream only).....	62
9.2.6.	Unbalance about earth (upstream and downstream)	63
9.3.	"ADSL.FDD over POTS" Signals	65
9.4.	"ADSL.FDD over ISDN" Signals	65
10.	Cluster 5 Signals (broad band up to 30 MHz)	65
10.1.	"VDSL" Signals	65

11.	Measurement methods of signal parameters.....	65
11.1.	Narrow-band signal power (voltage).....	65
11.2.	Unbalance about earth.....	66
11.2.1.	Definition of earth	66
11.2.2.	Transmitter Balance - LOV.....	66
11.2.3.	Receiver Balance - LCL.....	67
	Bibliography	69
	History.....	71

1. Scope

The present document gives guidance on a common language for Spectral Management specifications. It provides a first set of definitions on Spectral Management quantities, including

- (a) a description of the technical purpose of Spectral Management,
- (b) a common reference model to identify LT-ports, NT-ports, upstream, downstream, etc.
- (c) a minimum set of characteristics necessary to describe signals within the context of Spectral Management, and
- (d) an initial informative library of electrical signals that may flow into the ports of a metallic access network.

The present document is applicable to simplify & harmonise the description of *network specific* Spectral Management documents. The objective is to be a clear reference for these documents, without making any specific choice on the technology mix that may use the access network. Network-specific documents, that rule the selected penetration limits and technology mix for Spectral Management purposes, can be kept compact by referring to the definitions in this document.

The informative library of signal definitions is organised in clusters of signal categories. Each category defines, independent from other categories, a full set of signal limits between DC and 30 MHz. These categories are dominantly based on transmission equipment standards from ETSI, ITU and ANSI (existing or in progress), and on the technical understanding of additional requirements to protect future technology. When these definitions are incomplete or not appropriated, *network specific* spectral management documents may use additional definitions.

2. Definition of terminology, symbols and abbreviations

2.1. Terminology

For the purposes of the present document, the following terms and definitions apply:

Network owner: The company owning the telecommunication access network. (Mostly incumbent telecommunication network operators.)

Network operator: The company that make use of the access network of the Network owner, to transport telecommunication services.

Transmission technique: Electrical technique used for the transportation of information over electrical wiring.

Transmission equipment: Equipment connected to the access network that uses a transmission technique to transport information.

Line Termination Port (LT-port) : Port between network transmission equipment and the twisted pair access network, that is labelled by the network owner as "LT-port". Such a port is commonly located near the telecommunication exchange.

Network Termination Port (NT-port): Port between network transmission equipment and the twisted pair access network, that is labelled by the network owner as "NT-port". Such a port is commonly located at the customer premises.

Upstream transmission: Transmission direction from an NT-port to an LT-port, usually from the customer premises, via the access network, to the telecommunication exchange.

Downstream transmission: Transmission direction from an LT-port to an NT-port, usually from the telecommunication exchange via the access network, to the customer premises.

Degree of penetration: Number and mixture of connected transmission techniques to the ports of a binder or cable bundle, that inject signals into the access network.

2.2. Abbreviations

For the purposes of the present document, the following abbreviations apply:

ADSL	Asymmetrical Digital Subscriber Line
ATU-C	ADSL Transceiver Unit, Central office end
ATU-R	ADSL Transceiver Unit, Remote terminal end
AMI	Alternate Mark Inversion
ANSI	American National Standards Institute
BRA	Basic Rate Access
CSS	Customer-side signal source
CAP	Carrier Amplitude Modulation
CCITT	Comité Consultatif International du Téléphone et de la Télégraphie
CDSL	Customer Digital Subscriber Line
DC	Direct Current
EMC	Electro Magnetical Compatibility
ESS	Exchange-side signal source
ETSI	European Telecommunications Standards Institute
FDD	Frequency Division Duplexing
HDSL	High bitrate Digital Subscriber Line
ISDN	Integrated Services Digital Network
ITU	International Telecommunication Union
LCL	Longitudinal Conversion Loss
LOV	Longitudinal Output Voltage
LT-port	Line Termination port
LVD	Low Voltage Directive
MDF	Main Distribution Frame
NBSP	Narrow band signal power
NBSV	Narrow band signal voltage
NT-port	Network Termination port
NTE	Network Terminal Equipment
NTI	Network Terminal Interface
OLO	Other Licensed Operator
ONP	Open Network Provision
PCM	Pulse Code Modulation
PSD	Power Spectral Density
POTS	Plain Old Telephony Services
PSTN	Public Switched Telephone Network
R&TTE	Radio and Telecommunications Terminal Equipment
RMS	Root Mean Square
SDSL	Symmetrical (single pair high bitrate) Digital Subscriber Line
TBR	Technical Basis for Regulation
UNI	User Network Interface
U-ADSL	Universal Asymmetrical Digital Subscriber Line
VDSL	Very high bit rate Digital Subscriber Line
xDSL	(all systems) Digital Subscriber Line

3. The technical purpose of Spectral Management

Connecting a signal to a wire pair of a (metallic) access network cable, causes that parts of that signal couple to other wire pairs in the same cable bundle or binder group. Connecting more systems to the same cable will increase the total crosstalk noise level in each wire-pair, and disturbs systems that were already installed.

Existing access network cables are designed to facilitate a low crosstalk coupling at low frequencies (telephony band), but the frequency of signals in cables increases substantially due to the introduction of broadband transmission systems. The consequence will be a substantially increase of the total crosstalk noise power in each wire pair.

Existing transmission systems are designed to cope (to some extent) with this type of impairment, but impairment puts anyhow a limit on the capacity of what can be transported through that cable. Capacity means here the maximum bitrate that can be transported over a single wire-pair at given cable length, or the maximum length that can be reached at given bitrate. Above some impairment level, the reliability of installed systems becomes poor, and they will even fail when the impairment level is increased further.

Usually, systems are designed to function optimally when they are only impaired by identical systems (self-crosstalk) that use other wire-pairs in the same cable. In practice, it is quite common to mix different transmission technologies in one cable. This may cause some degradation of transmission capacity, compared to the above mentioned idealised situation.

- If this degradation is minor, the technology mix is referred to as *compatible*.
- If this degradation is acceptable, the technology mix is referred to as *near-compatible*.
- If this degradation is not-acceptable, the technology mix is referred to as *incompatible*.

To prevent that only a few systems make an inefficient use of the access network, at the cost of all the others, measures have to be taken. This is referred to as "Spectral Management".

3.1. Bounding spectral pollution

The objective for *spectral management* is to control the maximum spectral pollution, to enable an efficient use of the access network for all connected systems. This can be achieved by focussing on the use of near-compatible systems in the *same cable* or cable bundle.

Spectral management is an issue for both the network owner and the network operator (in some cases they are within the same organisation).

- The best that an *access network owner* can do to help the network operator(s) on its network, is to bound the spectral pollution in its network. This can be achieved by putting limits on signals (levels, spectra), diversity (technology mix) and penetration (number of systems). These limits may be dependent on the loop length. Defining relevant limits at the boundaries (or ports) of the access network is the most appropriate approach. This approach is not restricted to situations where more than one licence operator make use of the same binders or cable bundles; it is also essential when one operator mixes different broadband technologies into one binder or cable bundle.
- The best that *network operators* can do is making estimates of the maximum impairment level in a wire-pair, and define adequate deployment rules. Deployment rules define the maximum reach or bitrate for a given transmission technology, with 'sufficient' noise margin (according to the network operator). Since the crosstalk coupling between the wire pairs in binders or cable bundles is only known by a very rough approximation, the maximum impairment level is also only known by a very rough estimate. In other words: the definition of adequate limits is an essential requirement for successful deployment rules, but it can never *guarantee* that deployment rules can be adequate under all conditions. It is an inconvenience which each network operator has to face.

This document provides an informative library of signal categories, to simplify spectral management specifications that bound the spectral pollution of a network. Guidelines for deployment rules are beyond the scope of this document. A spectral management specification of a possible length dependency of the signal limits is also beyond the scope of this document.

3.2. The Individual Components of Spectral Pollution

Defining adequate rules for controlling spectral pollution requires a technical understanding of how individual disturbers contribute to the total impairment. The crosstalk coupling functions and the attenuation characteristics of an existing access network are fixed and from an electrical point of view the network can be considered as a closed entity. Controlling the spectral pollution is therefore restricted to controlling what signals may, and may not, flow into the access network cables.

Figure 1 illustrates the impact of these cable characteristics on the transmission. Transceiver TR1.LT sends information to TR1.NT.

- Receiver TR1.NT receives the downstream signal from transmitter TR1.LT, that has been attenuated by the insertion loss of the wire-pair.
- In addition, TR1.NT receives crosstalk noise through the NEXT coupling function (near end crosstalk), from the upstream signal transmitted by TR2.NT.
- In addition, TR1.NT receives crosstalk noise through the FEXT coupling function (far end crosstalk), from the downstream signal transmitted by TR2.LT.

This crosstalk noise deteriorates the signal to noise ratio of the received signal, and therefore the performance of the transmission between TR1.LT and TR1.NT.

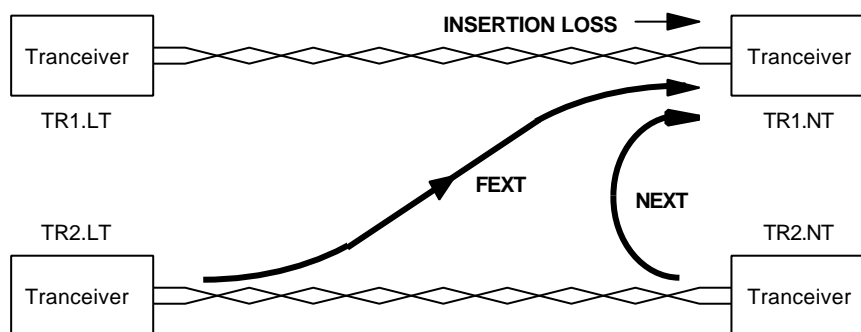

Figure 1. Various crosstalk paths .

Crosstalk and attenuation characteristics are frequency dependent. Because of the differences in crosstalk coupling at the near and the far end, the relation between frequency allocation and sending direction is of major importance for the management of the crosstalk noise.

The crosstalk coupling to the far end of the transmitter (FEXT) is relatively low due to the attenuation. The crosstalk on the near end (NEXT) will be relatively high. So if the transmitter and the receiver at one end of the line would use the same frequency band, the transmitter outputs should be limited in order not to disturb the adjacent receivers. The result would be that the achievable wire-pair length would be limited because crosstalk limits the maximum allowed sending level. By using different frequency bands for transmitters and receivers at one end of the binder or cable bundle, this effect can be eliminated and the achievable length will increase.

NOTE Some systems, such as FDD-based ADSL, take advantage from allocating different frequency bands for transmitting signals in upstream and downstream direction. By using spectra that are only partly overlapped (echo-cancelled systems), or not overlapped at all (FDD-systems), the NEXT between these systems can be reduced significantly. Ideally, if there is no spectral overlap between up and downstream signals, and the binder or cable bundle is only filled with these systems, the transmission performance becomes FEXT-limited only since all NEXT has been eliminated.

NOTE Consider the example of FEXT-limited ADSL: the NEXT at the NT due to neighbouring HDSL systems can limit the ADSL downstream performance. By restricting the deployment distance of HDSL, the NEXT disturbance at the NT of longer ADSL lines will be attenuated by the extra cable length, increasing the ADSL capacity (or reach for a given capacity). It follows that the deployment range limit of HDSL systems has an impact on the deployment range limit of ADSL. This example shows that it may be desirable to make the specifications for the signal limits dependent on the loop length.

4. Reference model of the local loop wiring

This clause describes the reference model of the *local loop wiring* of an access network, from a spectral management point of view. It illustrates that local loop cable sections are asymmetrical in nature, because equipment near the local exchange side may differ from equipment near the customer side.

The Local Loop Wiring (LLW) of an access network includes mainly cables, but may also include a Main Distribution Frame (MDF), street cabinets, and other distribution elements.

From a Spectral Management point of view, signal sources are identified on their location:

- CSS: Customer-side Signal Sources
- ESS: Exchange-side Signal Sources (such as local exchanges)
- RSS: Remote Signal Sources (such as repeaters and optical network units in street cabinets)

4.1. The concept of a Port, the interface the Local Loop Wiring

To give signal sources access to the Local Loop Wiring, their signals enter the LLW by flowing through so-called "ports". The ports are the interfaces to the Local Loop Wiring, and should therefore be well identified.

The following port-types are defined in this reference model:

- **LT-port**: The Line Termination port is generally used for connecting an ESS to the LLW.
- **NT-port**: The Network Termination port is generally used for connecting an CSS to the LLW.
- **LT.cab-port**: The LT-cabinet port is generally used for connecting an RSS to the LLW, that links this port with an NT-port (or NT.cab-port) elsewhere in the LLW.
- **NT.cab-port**: The NT-cabinet port is generally used for connecting an RSS to the LLW, that links this port with an LT-port (or LT.cab-port) elsewhere in the LLW.

At least two ports are required for communication. In special cases where access to the LLW at additional well-identified ports (such as in street cabinets) is provided for remote active devices (such as repeaters and optical network units), more ports may be involved.

4.2. Bounding Spectral Pollution by limiting signals at the Ports

The signal limits that are summarised in this document, are to limit injected signals as they can be observed at the ports of the LLW.

The signals that many DSL systems generate are asymmetrical in nature. For instance ADSL systems generate different data signals in different transmission directions. ISDN and HDSL systems are symmetrical in their data signals, but their remote DC power feeding is asymmetrical. Therefore different port names are used in the Reference Model to simplify the description of signal limits that are transmission direction dependent.

NOTE Reversing the transmission direction is generally not recommended, and may be implicitly forbidden by asymmetric signal limits at the ports. For example, ADSL systems are designed to maximise self-compatibility when all 'downstream' signals in one cable flow into the same direction. Typically connection of one system the other way round would harm neighbouring systems unacceptably, and is excluded when it violates the limits.

In the case of symmetric signal limits, no further distinction on transmission direction is made. In the case of asymmetric signal limits, the following naming convention is used in this document:

- **Downstream** signal limits are mandatory for signals that are injected into an LT-port (or LT.cab-port) of the Local Loop Wiring. LT-ports are usually located at the central office side of the local loop wiring.
- **Upstream** signal limits are mandatory for signals that are injected into an NT-port (or NT.cab-port) of the Local Loop Wiring. NT-ports are usually located at the customer side.

For each port, it must be well-identified if this is an LT- or NT-port, and which signal limits are mandatory for these ports.

NOTE An example of unintended reversal of transmission direction may occur when the main distribution frame (MDF) of another licensed operator is not co-located with the MDF of the network owner (at the local exchange). If some of the wire pairs of a distribution cable are used for connecting these two MDF's, then upstream and downstream signals in different wire pairs have to flow in the same cable direction. In such a case, a so-called tie-cable can solve the problem. Such a tie-cable should be fully dedicated to this purpose, and fully *separated* from the standard distribution cables.

NOTE Signal limits need not be the same for all NT-ports or LT-ports. It is conceivable that the signal limits depend on e.g. the loop length. A specification of this possible length dependence is beyond the scope of this document.

4.3. Reference model

Figure 2 shows a generic reference model of the Local Loop Wiring, from a Spectral Management point of view. The signals of various Signal Sources connected to the LLW flow into the LLW through *well-identified* ports. The following naming convention is used:

- The signals that flow through an *LT-port* into the Local Loop Wiring have their origin in a *Exchange-side Signal Source* (ESS), such as for instance a local exchange. When signal limits are direction dependent, the signals labelled in this document as *downstream* are intended for injection into these LT-ports, unless explicitly stated otherwise.
- The signals that flow through an *NT-port* into the Local Loop Wiring have their origin in a *Customer-side Signal Source* (CSS). When signal limits are direction dependent, the signals labelled in this document as *upstream* signals are intended for injection into these NT-ports, unless explicitly stated otherwise.
- The signals that flow through an optional *LT.cab-port* or *NT.cab-port* into the Local Loop Wiring have their origin in *Remote Signal Sources* (RSS). Their signal limits may be different from the limits that hold for LT-ports and NT-ports.

This model enables the identification of upstream and downstream directions. Furthermore, a distinction between NT-ports may be made on the basis of the loop length, when specifying signal limits on the ports.

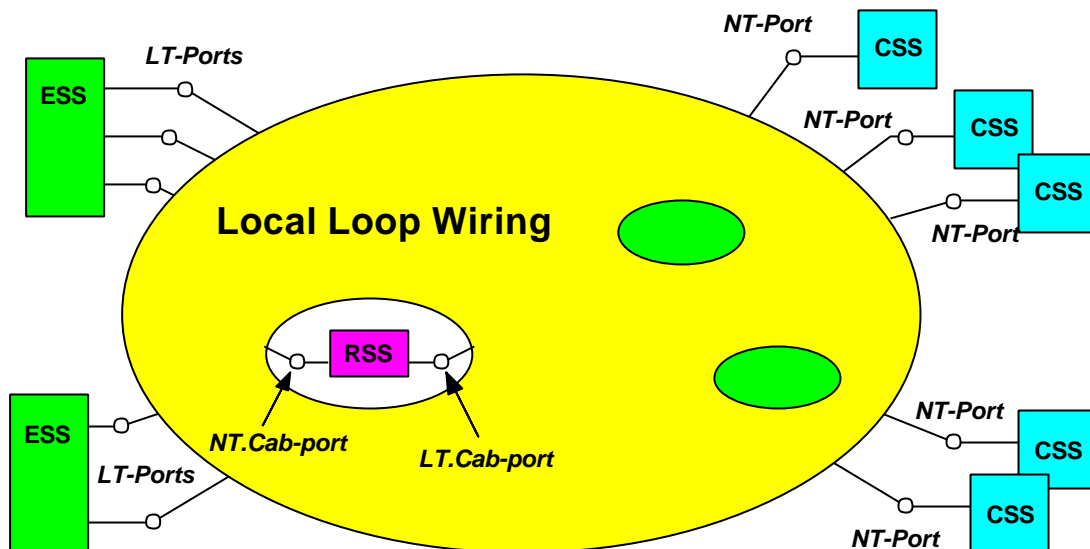

CSS: Customer-side Signal Source
 ESS: Exchange-side Signal Source
 RSS: Remote Signal Source
 LT-port: Line Termination Port, for injecting downstream signals from a ESS.
 NT-port: Network Termination Port, for injecting upstream signals from a CSS.

LT.cab-port: LT-cabinet Port, for injecting downstream signals from a RSS
 NT.cab-port: NT-cabinet Port, for injecting upstream signals from a RSS

Figure 2. Reference model of the local loop wiring of an access network. This model enables the definition of upstream and downstream directions. Furthermore, a distinction between NT-ports may be made on the basis of the loop length, when specifying signal limits on the ports.

NOTE: "Connecting a Signal Source to a port of the Local Loop Wiring", does not necessary mean "intended for transmission through that local loop wiring". For instance, in-house transmission equipment (such as home-PNA), may use existing in-house telephony wires, so they are also "connected to the local loop wiring". They will (unintentional) inject signals into the Local Loop Wiring via the NT-ports. These signals are subject to the signal limits at the ports.

5. Minimum set of characteristics for signal descriptions

To classify signals for spectral management purposes, the following parameters are relevant:

- Total signal voltage (or power)
- Peak amplitude
- Narrow-band signal voltage (or power)
- Unbalance about earth (LOV and LCL)
- Feeding Power (if relevant)

In some cases, additional parameters are required, such as feeding requirements (in case of remote powering) and ringing signals.

6. Cluster 1 Signals (voice band)

This cluster summarises signals that are generated by analogue transmission equipment (including POTS), voice band modems, analogue leased lines, telex signals encoded as voice band signals and music lines.

6.1. "POTS" Signals (voice band lines 300 - 3400Hz)

This category covers signals from telephony transmission equipment (e.g. telephones, voice band modems, Faxes, analogue leased lines etc.) on a single wire pair. Unless other specified, the requirements on DTMF-signals (Dual Tone Multi-Frequency), as defined in [1], are equal to the voice signal.

A signal can be classified as a "POTS signal" if it is compliant with all sub clauses below.

6.1.1. Total signal voltage

To be compliant with this signal category, the mean signal voltage over a reference impedance Z_R (see figure 5) shall not exceed a level of -9,7 dBV, measured within a frequency band from at least 200 Hz to 3,8 kHz, and over a one-minute period. This requirement does not apply to DTMF signals.

Reference [1]: [ETSI-TBR21: clause 4.7.3.1], (tested according to annex A, sub clause A.4.7.3.1)

To be compliant with this signal category, the level of any tone in the DTMF high frequency group shall not be greater than $-9,0 \text{ dBV} + 2,0 \text{ dB} = -7,0 \text{ dBV}$. The level of any tone in the low frequency group shall not be greater than $-11,0 \text{ dBV} + 2,5 \text{ dB} = -8,5 \text{ dBV}$. This is to be measured when the TE interface is terminated with the specified reference impedance Z_R (see figure 5).

Reference [1]: [ETSI-TBR2: clause 4.8.2.2.1] (tested according to annex A, sub clause A.4.8.2.2)

6.1.2. Peak amplitude

To be compliant with this signal category, the peak to peak signal voltage over a reference impedance Z_R (see figure 5) shall not exceed a level of 5,0 volts, measured within a frequency band from at least 200 Hz to 3,8 kHz.

Reference [1]: [ETSI-TBR21: clause 4.7.3.2] (tested according to annex A, sub clause A.4.7.3.2)

6.1.3. Narrow-band signal voltage

To be compliant with this signal category, the narrow-band signal voltage (NBSV) shall not exceed the limits given in table 1, at any point in the frequency range 100 Hz to 30 MHz. This table specifies the break points of these limits, in which Z_R refers to the specified reference impedance Z_R (see figure 5). Limits for intermediate frequencies can be found by drawing a straight line between the break points on a logarithmic (Hz) - linear (dB) scale. Figure 3 illustrates the NBSV in a bandwidth-normalised way.

The NBSV is the average rms-voltage U of a sending signal into a (complex) load impedance Z , within a power bandwidth B . The measurement method of the NBSV is described in sub-clause 12.1.

Reference [1]: [ETSI-TBR21: (30 Hz - 4.3kHz, clause 4.7.3.3), (4.3 kHz - 200kHz, clause 4.7.3.4)] the requirements above 200kHz are extended from [1]. This extension is essential to guarantee compatibility with broadband xDSL systems.

frequency f	impedance Z	Signal Level U	Power Bandwidth B	Spectral Voltage U/ÖB
30 Hz	Z_R	-33,7 dBV	10 Hz	-43,7 dBV/√Hz
100 Hz	Z_R	-10,7 dBV	10 Hz	-20,7 dBV/√Hz
200 Hz	Z_R	-6,7 dBV	10 Hz	-16,7 dBV/√Hz
3,8 kHz	Z_R	-6,7 dBV	10 Hz	-16,7 dBV/√Hz
3,9 kHz	Z_R	-10,7 dBV	10 Hz	-20,7 dBV/√Hz
4,0 kHz	Z_R	-16,7 dBV	10 Hz	-26,7 dBV/√Hz
4,3 kHz	Z_R	-44,7 dBV	10 Hz	-54,7 dBV/√Hz
4,3 kHz	Z_R	-40 dBV	300 Hz	-65 dBV/√Hz
5,1 kHz	Z_R	-44 dBV	300 Hz	-69 dBV/√Hz
8,9 kHz	Z_R	-44 dBV	300 Hz	-69 dBV/√Hz
11,0 kHz	Z_R	-58,5 dBV	300 Hz	-73,5 dBV/√Hz
11,0 kHz	Z_R	-58,5 dBV	1 kHz	-88,5 dBV/√Hz
200 kHz	Z_R	-58,5 dBV	1 kHz	-88,5 dBV/√Hz
200 kHz	135 Ω	-60 dBV	1 kHz	-90 dBV/√Hz
500 kHz	135 Ω	-90 dBV	1 kHz	-120 dBV/√Hz
500 kHz	135 Ω	-60 dBV	1 MHz	-120 dBV/√Hz
30 MHz	135 Ω	-60 dBV	1 MHz	-120 dBV/√Hz

Table 1 Break points of the narrow-band voltage limits. A voltage of 1 V, equals 0 dBV, and causes a power of 2.2 dBm in 600 W and 8,7 dBm in 135 W.

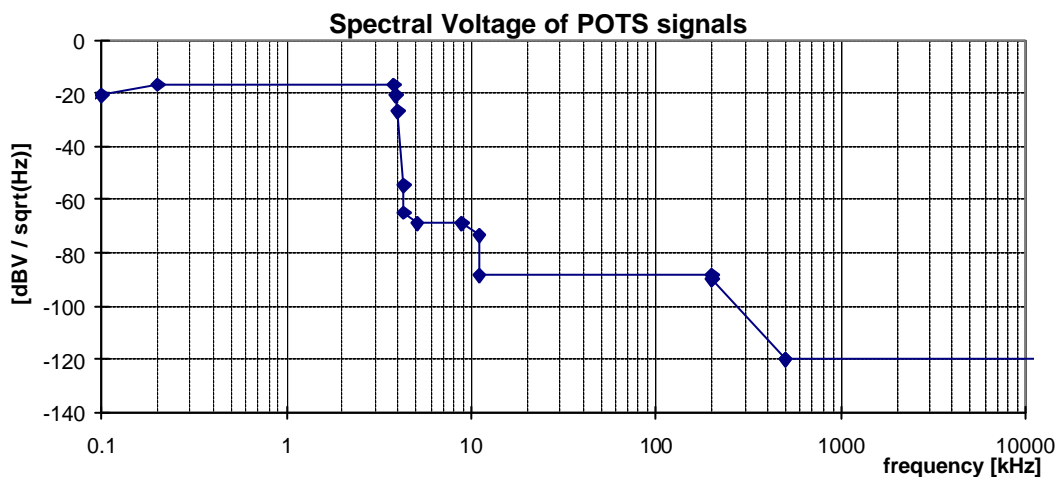

Figure 3: Spectral Voltage, for POTS signals, as specified in table 1.

During tone signalling the limits given in table 1 do not apply to DTMF signals and are replaced by the following limits:

- In the range 4,3 kHz to 20 kHz, the individual level of any single frequency component shall not exceed -35,7 dBV, when terminated with Z_R .
- In the range 20 kHz to 200 kHz, the individual level of any single frequency component shall not exceed -40,7 dBV, when terminated with Z_R .

- In the range 200 kHz to 30 MHz, the individual level of any single frequency component shall not exceed <TBD> when terminated with 135 Ω .

Reference [1]: [ETSI-TBR21: clause 4.7.3.4]

6.1.4. Unbalance about earth

To be compliant with this signal category, the balance of the signal that may flow through the LT-port or NT-port shall exceed minimum requirements, under the condition that the local loop wiring and its termination is well balanced. This can be verified by a longitudinal output voltage (LOV) and a longitudinal conversion loss (LCL) measurement at the source of that signal, as specified in sub-clause 12.2.2 and 12.2.3. The minimum LOV and LCL requirements hold for what can be observed at the ports of the Local Loop Wiring, when the Local Loop Wiring is replaced by an artificial impedance network described in sub-clause 12.2.2 and 12.2.3.

The differential termination impedance for LOV and LCL measurements shall be chosen equally to the impedance $R_T=R_1+R_2$, as specified in table 2.

	Value	Frequency range	Tolerance
Resistance R_T	300 ohm	50 Hz – 3800 Hz	
Resistance R_T	135/2 ohm	3800 Hz – 30 MHz	$R_1/R_2=1 \pm 0,1 \%$
TE powering by Feeding bridge according to ETSI-TBR 21 4.4.3			

Table 2: Values for the components for the terminating impedance for measuring the LOV and LCL.

The observed LOV shall have an rms voltage of below the value specified in table 3, measured in a power bandwidth B , centred over any frequency in the range from f_{\min} to f_{\max} , and averaged in any one second period. Compliance with this limitation is required with a longitudinal terminating impedance having value $Z_L(\omega)=R_T+1/(j\omega C_L)$ for all frequencies between f_{\min} to f_{\max} . Sub clause 12.2.2 defines an example measurement method for longitudinal output voltage.

The observed LCL shall be higher than the lower limits given in figure 4. The LCL values of the associated break frequencies of this figure are given in table 4. Sub clause 12.2.3 defines an example measurement method for longitudinal conversion loss.

Reference [1]: [ETSI-TBR 21: clause 4.4.3 and 4.7.4.1]

Reference [4]: [ETSI-ETS 300 450: clause 4.4.2]

Reference [5]: [ETSI-ETS 300 453: clause 4.4.2]

Reference [20]: [ETSI-TS 101 270-1: clause 8.3.3]

LOV	B	f_{\min}	f_{\max}	R_L	C_L
-46dBV	1 kHz	510 Hz	10 kHz	100 Ω	150 nF

Table 3: Values for the LOV limits.

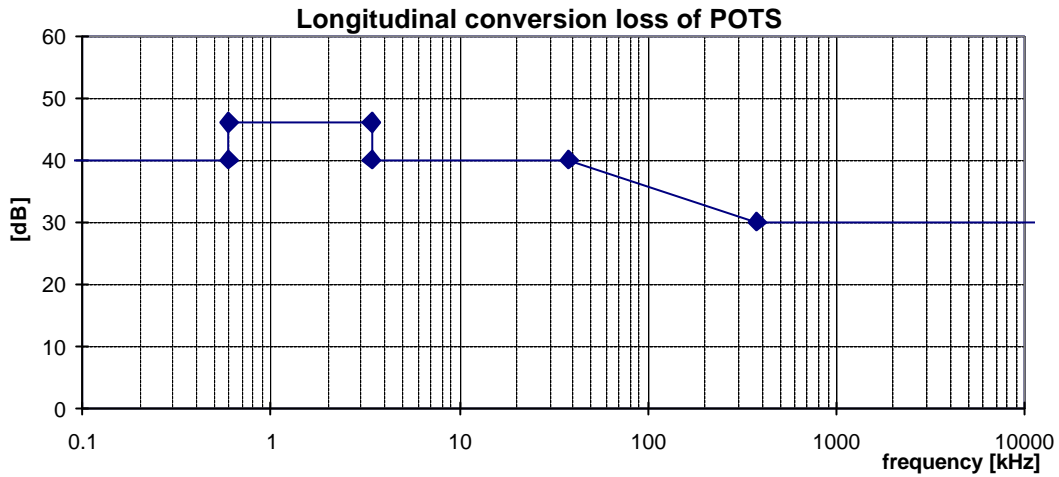

Figure 4: Minimum longitudinal conversion loss for a POTS-signal source

Frequency range	Minimum value	Impedance
50 Hz to 600 Hz	40 dB	600 Ω
600 Hz to 3400 Hz	46 dB	600 Ω
3400 Hz to 3800 Hz	40 dB	600 Ω
3800 Hz to 38 kHz	40 dB	135 Ω
38 kHz to 380 kHz	40 to 30 dB	135 Ω
380 kHz to 30 MHz	30 dB	135 Ω

Table 4: Frequencies and LCL values of the breakpoints of the LCL mask in figure 4.

6.1.5. Feeding Power (from the LT-port)

To be compliant with this signal category, the DC feeding voltage and feeding current, used for the POTS service shall not exceed the maximum values in table 5.

Reference [2]: [ETSI- EG 201 188: clause 6.2.1 and 6.3.1]

Reference [3]: [ETSI- EN 300 001: clause 1.5]

	Maximum Voltage:	Maximum Current :
ETSI- EG 201 188	78 V	55 mA
Country 1		
Country 2		

Table 5 Maximum feeding requirements for the POTS service

6.1.6. Reference impedance Z_R

The reference impedance Z_R , that is used to enable the specification of various signal levels, is the European harmonised complex impedance. This harmonised complex impedance (see figure 5) equals 270Ω in series with a parallel combination of 750Ω and 150 nF .

Reference [1]: [ETSI-TBR21: clause A.2.1]

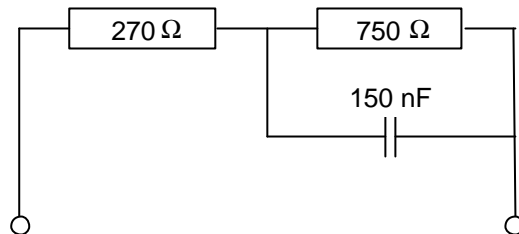

Figure 5: Reference impedance Z_R

6.1.7. Ringing signal

To be compliant with this signal category, the AC ringing voltage shall not exceed the maximum values in table 6. The AC ringing signal may be or may be not superimposed on the DC feeding voltage.

Reference [2]: [ETSI- EG 201 188: clause 12.1]

Reference [3]: [ETSI- EN 300 001: clause 1.7.2]

	Frequency	Maximum Voltage
ETSI- EG 201 188	$25 \pm 2 \text{ Hz}$	$100 V_{\text{rms}}$
Country 1	50 Hz	$100 V_{\text{rms}}$
Country 2		

Table 6 Maximum ringing signal (POTS service)

6.1.8. Metering signals

To be compliant with this signal category, 50 Hz common mode metering pulses (if added to POTS lines), shall be within the limits of table 7.

NOTE: Most access networks are using a different type of metering signals.

Reference [3]: [ETSI ETS 300 001: clause 1.7.8]

Frequency	Voltage	Pulse width
48 to 52 Hz	maximum $100 V_{\text{eff}}$	70 to 200 ms

Table 7 Maximum metering signal.

7. Cluster 2 Signals (semi broad band)

This cluster summarises signals that are generated by digital transmission equipment up to 160 kb/s, including ISDN-BRA and 64 and 128 kb/s leased lines.

7.1. "ISDN.2B1Q" Signals

This category covers signals generated by ISDN transmission equipment on a single wire-pair, based on 2B1Q line coding. This sub clause is based on the ETSI reports on ISDN equipment [8].

A signal can be classified as an "ISDN.2B1Q signal" if it is compliant with all subclauses below.

7.1.1. Total signal power

To be compliant with this signal category, the mean signal power into a resistive load of 135 Ω shall not exceed a level of 13,5 dBm (± 0.5 dBm), measured within a frequency band from at least 100 Hz to 80 kHz.

Reference [8]: [ETSI TS 102 080: clause A.12.3]

7.1.2. Peak amplitude

To be compliant with this signal category, the nominal voltage peak of the largest signal pulse into a resistive load of 135 Ω shall not exceed a level of 2,5 V ($\pm 5\%$), measured within a frequency band from at least 100 Hz to 80 kHz.

Reference [8]: [ETSI TS 102 080: clause A.12.1]

7.1.3. Narrow-band signal power

To be compliant with this signal category, the narrow-band signal power (NBSP) into a resistive load impedance R , shall not exceed the limits given in table 8, at any point in the frequency range 100 Hz to 30 MHz. This table specifies the break points of these limits. Limits for intermediate frequencies can be found by drawing a straight line between the break points on a logarithmic (Hz) - linear (dB) scale. Figure 6 illustrates the NBSP in a bandwidth-normalised way.

The NBSP is the average power P of a sending signal into a load resistance R , within a power bandwidth B . The measurement method of the NBSP is described in sub-clause 12.1.

NOTE The NBSP specification in table 8 is reconstructed from the commonly used PSD specification in [8] (similar to figure 6), and used here since it is much wider applicable. This enables a unified specification method. PSD specifications are adequate when signals are purely random in nature, but cannot cover harmonic components in a signal (would cause infinite high "PSD" levels at these harmonic frequencies). NBSP specifications cover both signal types.

The nature of the original PSD specification in [8] is in fact a NBSP specification, since the use of a 10 kHz bandwidth (above 10 kHz) and a 1 MHz bandwidth (above 300 kHz) is mandatory in [8]. The additional use of a sliding window PSD specification in [8], in order to make sure that different systems do not fill the entire allowable bandwidth with noise up to the PSD limit, illustrates the NBSP nature of the PSD specification in [8] in more detail. Mark that in [8] the lower frequency (300 kHz) has been specified, while table 8 specifies centre frequencies (starting at 300+500 kHz).

References [8]: [ETSI TS 102 080: clause A.12.4]

Centre Frequency f	Impedance R	Signal Level P	Power bandwidth B	Spectral Power P/B	
510 Hz	135Ω	-0 dBm	1 kHz	-30 dBm/Hz	A
10 kHz	135Ω	-0 dBm	1 kHz	-30 dBm/Hz	
10 kHz	135Ω	10 dBm	10 kHz	-30 dBm/Hz	
50 kHz	135Ω	10 dBm	10 kHz	-30 dBm/Hz	
500 kHz	135Ω	-40 dBm	10 kHz	-80 dBm/Hz	
1,4 MHz	135Ω	-40 dBm	10 kHz	-80 dBm/Hz	
5 MHz	135Ω	-80 dBm	10 kHz	-120 dBm/Hz	
30 MHz	135Ω	-80 dBm	10 kHz	-120 dBm/Hz	
800 kHz	135Ω	-30 dBm	1 MHz	-90 dBm/Hz	B
1,4 MHz	135Ω	-30 dBm	1 MHz	-90 dBm/Hz	
3,637 MHz	135Ω	-60 dBm	1 MHz	-120 dBm/Hz	
30 MHz	135Ω	-60 dBm	1 MHz	-120 dBm/Hz	

Table 8: Break points of the narrow-band power limits.

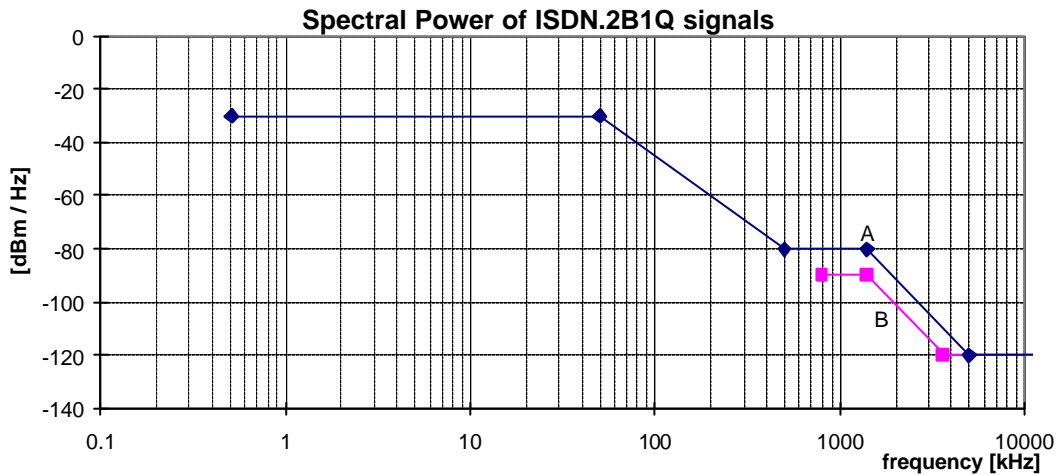

Figure 6: Spectral Power, for ISDN.2B1Q signals, as specified in table 8.

7.1.4. Unbalance about earth

To be compliant with this signal category, the balance of the signal that may flow through the LT-port or NT-port shall exceed minimum requirements, under the condition that the local loop wiring and its termination is well balanced. This can be verified by a longitudinal output voltage (LOV) and a longitudinal conversion loss (LCL) measurement at the source of that signal, as specified in sub-clause 12.2.2 and 12.2.3. The minimum LOV and LCL requirements hold for what can be observed at the ports of the Local Loop Wiring, when the Local Loop Wiring is replaced by an artificial impedance network described in sub-clause 12.2.2 and 12.2.3.

The differential termination impedance for LOV and LCL measurements shall be chosen equally to the design impedance $R_T=135 \Omega$ of the Signal Source under test.

The observed LOV shall have an rms voltage of below the value specified in table 9, measured in a power bandwidth B, centred over any frequency in the range from f_{min} to f_{max} , and averaged in any one second period. Compliance with this

limitation is required with a longitudinal terminating impedance having value $Z_L(\omega)=R_L+1/(j\omega C_L)$ for all frequencies between f_{min} to f_{max} . Sub clause 12.2.2 defines an example measurement method for longitudinal output voltage.

The observed LCL shall be higher than the lower limits given in figure 7. The LCL values of the associated break frequencies of this figure are given in table 10. Sub clause 12.2.3 defines an example measurement method for longitudinal conversion loss.

Reference [8]: [ETSI TS 102 080: clause A.13.3.1] extended to 30 MHz according to [20].

Reference[20]: [ETSI TS 101 270-1: clause 8.3.3]

LOV	B	f_{min}	f_{max}	R_L	C_L
-46dBV	10 kHz	5,1 kHz	225 kHz	100Ω	150 nF

Table 9: Values for the LOV limits.

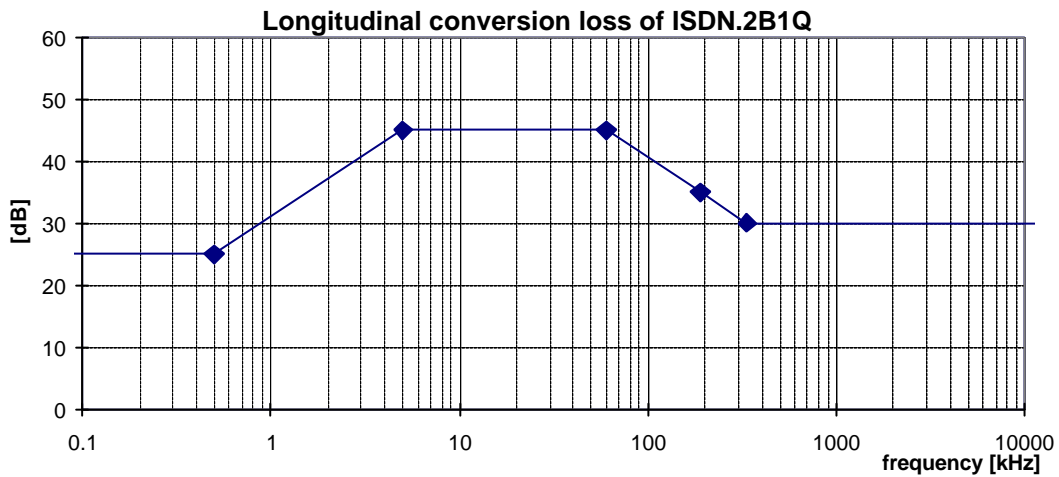

Figure 7: Minimum longitudinal conversion loss for a ISDN.2B1Q signal source

Frequency range	LCL
<0,5 kHz	25 dB
5 kHz	45 dB
60 kHz	45 dB
190 kHz	35 dB
337 kHz	30 dB
30 MHz	30 dB

Table 10: Frequencies and LCL values of the breakpoints of the LCL mask in figure 7.

7.1.5. Feeding Power (from the LT-port)

To be compliant with this signal category, the DC feeding voltage and feeding current, used for the ISDN service shall not exceed the maximum values in table 55. The value for power includes a possible overload or short circuit condition at the user-network interface.

Reference [8]: [ETSI TS 102 080: clause 10.5 and 10.6.1.1]

Voltage	Current	Power at NT-port
Maximum 99 V	40 mA	maximum 1100 mW

Table 11 Maximum feeding requirements for the ISDN service

7.2. "ISDN.MMS.43" Signals

This category covers signals generated by ISDN transmission equipment on a single wire-pair, based on MMS 43 (also known as 4B3T) line coding. This sub clause is based on the ETSI reports on ISDN equipment [8].

A signal can be classified as an "ISDN.MMS.43" signal if it is compliant with all subclauses below.

7.2.1. Total signal power

To be compliant with this signal category, the mean signal power into a resistive load of 150 Ω shall not exceed a level of 13,5 dBm ($\pm 0,5$ dBm), measured within a frequency band from at least 100 Hz to 100 kHz.

No full reference. Derived from reference [8]: [ETSI TS 102 080: clause A.12.3]

7.2.2. Peak amplitude

To be compliant with this signal category, the nominal voltage peak of the largest signal pulse into a resistive load of 150 Ω shall not exceed a level of 2,0 V ($\pm 5\%$), measured within a frequency band from at least 100 Hz to 100 kHz.

Reference [8]: [ETSI TS 102 080: clause B.12.1]

7.2.3. Narrow-band signal power

To be compliant with this signal category, the narrow-band signal power (NBSP) into a resistive load impedance R , shall not exceed the limits given in table 12, at any point in the frequency range 100 Hz to 30 MHz. This table specifies the break points of these limits. Limits for intermediate frequencies can be found by drawing a straight line between the break points on a logarithmic (Hz) - linear (dB) scale. Figure 8 illustrates the NBSP in a bandwidth-normalised way.

The NBSP is the average power P of a sending signal into a load resistance R , within a power bandwidth B . The measurement method of the NBSP is described in sub-clause 12.1.

NOTE The NBSP specification in table 12 is reconstructed from the commonly used PSD specification in [8] (similar to figure 8), and used here since it is much wider applicable. This enables a unified specification method. PSD specifications are adequate when signals are purely random in nature, but cannot cover harmonic components in a signal (would cause infinite high "PSD" levels at these harmonic frequencies). NBSP specifications cover both signal types.

The nature of the original PSD specification in [8] is in fact a NBSP specification, since the use of a 10 kHz bandwidth (above 10 kHz) and a 1 MHz bandwidth (above 300 kHz) is mandatory in [8]. The additional use of a sliding window PSD specification in [8], in order to make sure that different systems do not fill the entire allowable bandwidth with noise up to the PSD limit, illustrates the NBSP nature of the PSD specification in [8] in more detail.

Mark that in [8] the lower frequency (300 kHz) has been specified, while table 12 specifies centre frequencies (starting at 300+500 kHz).

References [8]: [ETSI TS 102 080: clause B.12.4]

Centre Frequency f	Impedance R	Signal Level P	Power bandwidth B	Spectral Power P/B	
0,51Hz	150 Ω	-0 dBm	1 kHz	-30 dBm/Hz	A
10 kHz	150 Ω	-0 dBm	1 kHz	-30 dBm/Hz	
10 kHz	150 Ω	10 dBm	10 kHz	-30 dBm/Hz	
50 kHz	150 Ω	10 dBm	10 kHz	-30 dBm/Hz	
300 kHz	150 Ω	-27 dBm	10 kHz	-67 dBm/Hz	
1 MHz	150 Ω	-27 dBm	10 kHz	-67 dBm/Hz	
5 MHz	150 Ω	-80 dBm	10 kHz	-120 dBm/Hz	
30 MHz	150 Ω	-80 dBm	10 kHz	-120 dBm/Hz	
800 kHz	150 Ω	-17 dBm	1 MHz	-77 dBm/Hz	B
1 MHz	150 Ω	-17 dBm	1 MHz	-77 dBm/Hz	
3,69 MHz	150 Ω	-60 dBm	1 MHz	-120 dBm/Hz	
30 MHz	150 Ω	-60 dBm	1 MHz	-120 dBm/Hz	

Table 12: Break points of the narrow-band power limits.

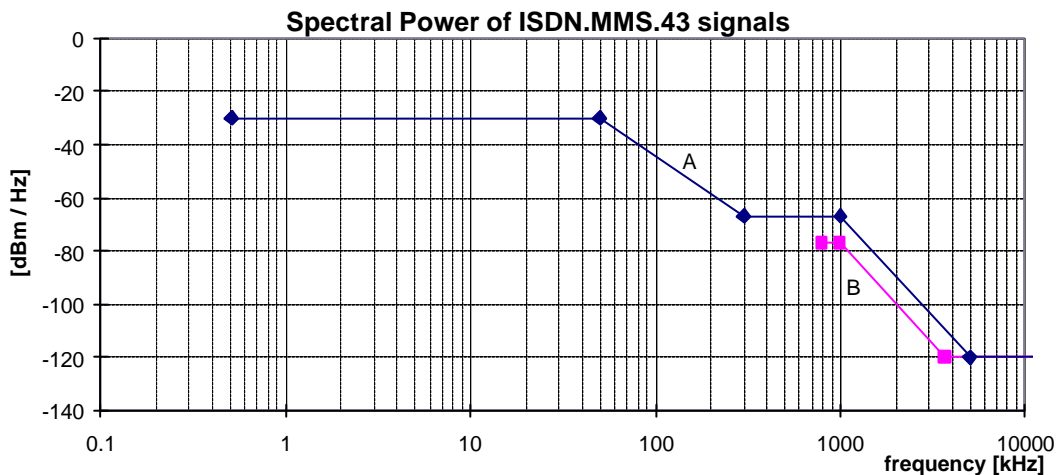

Figure 8: Spectral Power, for ISDN.MMS.43 signals, as specified in table 12.

7.2.4. Unbalance about earth

To be compliant with this signal category, the balance of the signal that may flow through the LT-port or NT-port shall exceed minimum requirements, under the condition that the local loop wiring and its termination is well balanced. This can be verified by a longitudinal output voltage (LOV) and a longitudinal conversion loss (LCL) measurement at the source of that signal, as specified in sub-clause 12.2.2 and 12.2.3. The minimum LOV and LCL requirements hold for what can be observed at the ports of the Local Loop Wiring, when the Local Loop Wiring is replaced by an artificial impedance network described in sub-clause 12.2.2 and 12.2.3.

The differential termination impedance for LOV and LCL measurements shall be chosen equally to the design impedance $R_T=150\ \Omega$ of the Signal Source under test.

The observed LOV shall have an rms voltage of below the value specified in table 13, measured in a power bandwidth B , centred over any frequency in the range from f_{\min} to f_{\max} , and averaged in any one second period. Compliance with this limitation is required with a longitudinal terminating impedance having value $Z_L(\omega)=R_L+1/(j\omega C_L)$ for all frequencies between f_{\min} to f_{\max} . Sub clause 12.2.2 defines an example measurement method for longitudinal output voltage.

The observed LCL shall be higher than the lower limits given in figure 9. The LCL values of the associated break frequencies of this figure are given in table 14. Sub clause 12.2.3 defines an example measurement method for longitudinal conversion loss.

Reference [8]: [ETSI TS 102 080: clause B.13.3] extended to 30 MHz according to [20].

Reference[20]: [ETSI TS 101 270-1: clause 8.3.3]

LOV	B	f_{\min}	f_{\max}	R_L	C_L
-46dBV	10 kHz	5,1 kHz	245 kHz	100 Ω	150 nF

Table 13: Values for the LOV limits.

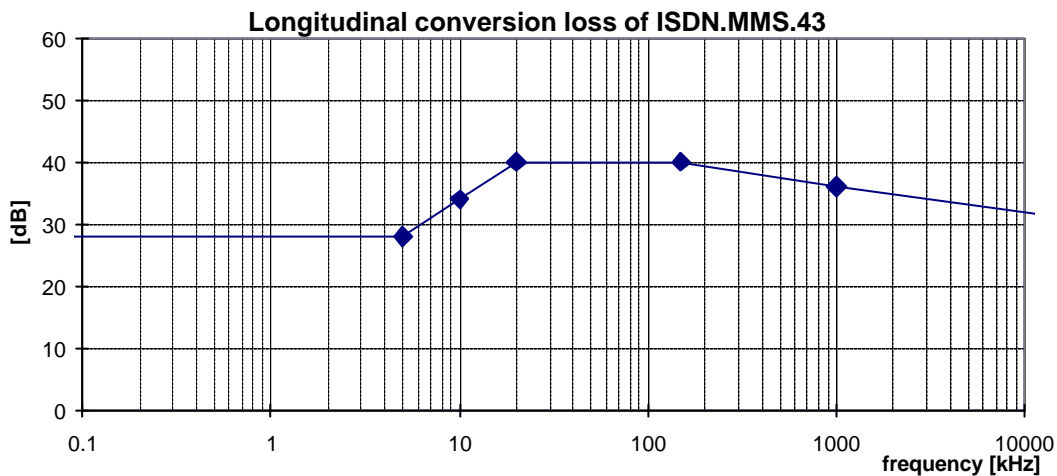

Figure 9: Minimum longitudinal conversion loss for a ISDN.MMS43 signal source

Frequency range	LCL
<5 kHz	28 dB
10 kHz	34 dB
20 kHz	40 dB
150 kHz	40 dB
1000 kHz	36 dB
30 MHz	30 dB

Table 14: Frequencies and LCL values of the breakpoints of the LCL mask in figure 9.

7.2.5. Feeding Power (from the LT-port)

To be compliant with this signal category, the DC feeding voltage and feeding current, used for the ISDN service shall not exceed the maximum values in table 15. The value for power includes a possible overload or short circuit condition at the user-network interface.

Reference [8]: [ETSI TS 102 080: clause 10.5 and 10.6.1.1]

Voltage	Current	Power at NT-port
Maximum 99 V	Maximum 55 mA	maximum 1100 mW

Table 15 Maximum feeding requirements for the ISDN service

8. Cluster 3 Signals (symmetrical broad band)

This cluster summarises symmetrical signals that are generated by digital transmission equipment up to 2 Mb/s, including HDSL and SDSL. If such a system requires more than one wire-pair for carrying that bitrate, the signal description holds for each individual wire-pair.

These signals are commonly used to carry services like high quality leased lines, with symmetrical bit rates (in up- and downstream directions).

8.1. "HDSL.2B1Q/3" Signals (392 kbaud leased lines)

This category covers signals, generated by HDSL transmission equipment on three wire-pairs, based on 2B1Q line coding. This sub clause is based on the ETSI reports on HDSL equipment [9]. These are essentially 392 kbaud systems (per wire-pair).

A signal (per wire-pair) can be classified as an "HDSL.2B1Q/3 signal" if it is compliant with all subclauses below. Unless otherwise indicated, the following signal specifications apply with a resistive load impedance of 135 Ω , and does not apply to the DC remote power feeding (if any).

8.1.1. Total signal power

To be compliant with this signal category, the mean signal power into a resistive load of 135 Ω shall not exceed a level of 14 dBm, measured within a frequency band from at least 100 Hz to 784 kHz.

Reference [9]: [ETSI TS 101 135: clause 5.8.4.4]

8.1.2. Peak amplitude

To be compliant with this signal category, the nominal voltage peak of the largest signal pulse into a resistive load of 135 Ω shall not exceed a level of 2,64 V (\pm 7%), measured within a frequency band from at least 100 Hz to 784 kHz.

Reference [9]: ETSI TS 101 135: clause 5.8.4.1]

8.1.3. Narrow-band signal power

To be compliant with this signal category, the narrow-band signal power (NBSP) into a resistive load impedance R , shall not exceed the limits given in table 16, at any point in the frequency range 100 Hz to 30 MHz. This table specifies the break points of these limits. Limits for intermediate frequencies can be found by drawing a straight line between the break points on a logarithmic (Hz) - linear (dB) scale. Figure 10 illustrates the NBSP in a bandwidth-normalised way.

The NBSP is the average power P of a sending signal into a load resistance R , within a power bandwidth B . The measurement method of the NBSP is described in sub-clause 12.1.

Reference: [9]: [ETSI TS 101 135: clause 5.8.4.3]. These numbers are reconstructed from PSD requirements in [9]

NOTE The NBSP specification in table 16 is reconstructed from the commonly used PSD specification in [9] (similar to figure 10), and used here since it is much wider applicable. This enables a unified specification method. PSD specifications are adequate when signals are purely random in nature, but cannot cover harmonic components in a signal (would cause infinite high "PSD" levels at these harmonic frequencies). NBSP specifications cover both signal types.

Centre Frequency f	Impedance R	Signal Level P	Power bandwidth B	Spectral Power P/B
0,51 kHz	135 Ω	-7 dBm	1 kHz	-37 dBm/Hz
10 kHz	135 Ω	-7 dBm	1 kHz	-37 dBm/Hz
10 kHz	135 Ω	3 dBm	10 kHz	-37 dBm/Hz
196 kHz	135 Ω	3 dBm	10 kHz	-37 dBm/Hz
1,96 MHz	135 Ω	-77 dBm	10 kHz	-117 dBm/Hz
1,96 MHz	135 Ω	-57 dBm	1 MHz	-117 dBm/Hz
30 MHz	135 Ω	-57 dBm	1 MHz	-117 dBm/Hz

Table 16 Break points of the narrow-band power limits. These limits are frequency independent between 100 Hz to 196 kHz, and decrease with 24 dB/octave (80 dB/decade) above 196 kHz.

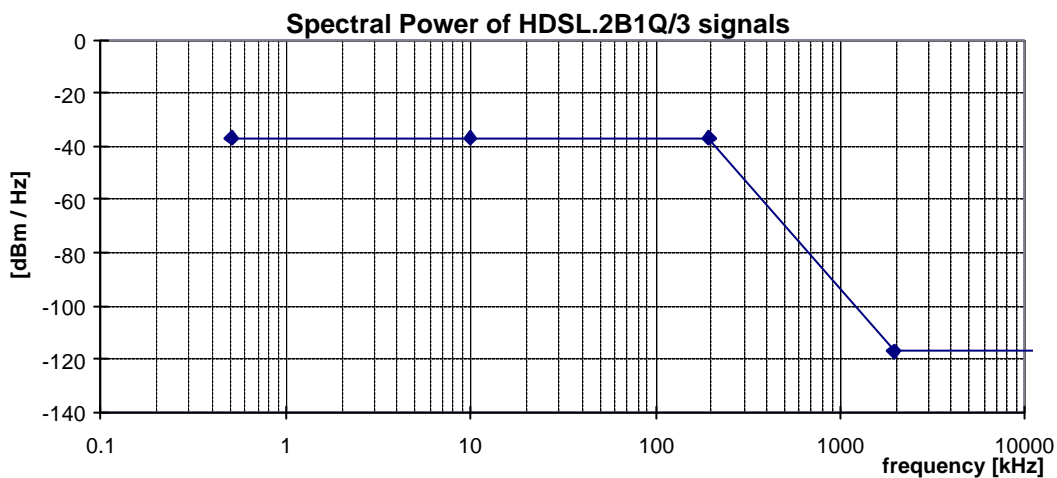

Figure 10: Spectral Power, for HDSL.2B1Q/3 signals, as specified in table 16.

8.1.4. Unbalance about earth

To be compliant with this signal category, the balance of the signal that may flow through the LT-port or NT-port shall exceed minimum requirements, under the condition that the local loop wiring and its termination is well balanced. This can be verified by a longitudinal output voltage (LOV) and a longitudinal conversion loss (LCL) measurement at the source of that signal, as specified in sub-clause 12.2.2 and 12.2.3. The minimum LOV and LCL requirements hold for what can be observed at the ports of the Local Loop Wiring, when the Local Loop Wiring is replaced by an artificial impedance network described in sub-clause 12.2.2 and 12.2.3.

The differential termination impedance for LOV and LCL measurements shall be chosen equally to the design impedance $R_T=135\ \Omega$ of the Signal Source under test.

The observed LOV shall have an rms voltage of below the value specified in table 17, measured in a power bandwidth B , centred over any frequency in the range from f_{\min} to f_{\max} , and averaged in any one second period. Compliance with this limitation is required with a longitudinal terminating impedance having value $Z_L(\omega)=R_T+1/(j\omega C_T)$ for all frequencies between f_{\min} to f_{\max} . Sub clause 12.2.2 defines an example measurement method for longitudinal output voltage.

The observed LCL shall be higher than the lower limits given in figure 11. The LCL values of the associated break frequencies of this figure are given in table 18. Sub clause 12.2.3 defines an example measurement method for longitudinal conversion loss.

Reference [9]: [ETSI TS 101 135: clause 5.8.5.1] extended to 30 MHz according to Reference[20].

Reference [20]: [ETSI TS 101 270-1: clause 8.3.3]

LOV	B	f_{\min}	f_{\max}	R_L	C_L
-46dBV	10 kHz	5,1 kHz	410 kHz	100 Ω	150 nF

Table 17: Values for the LOV limits.

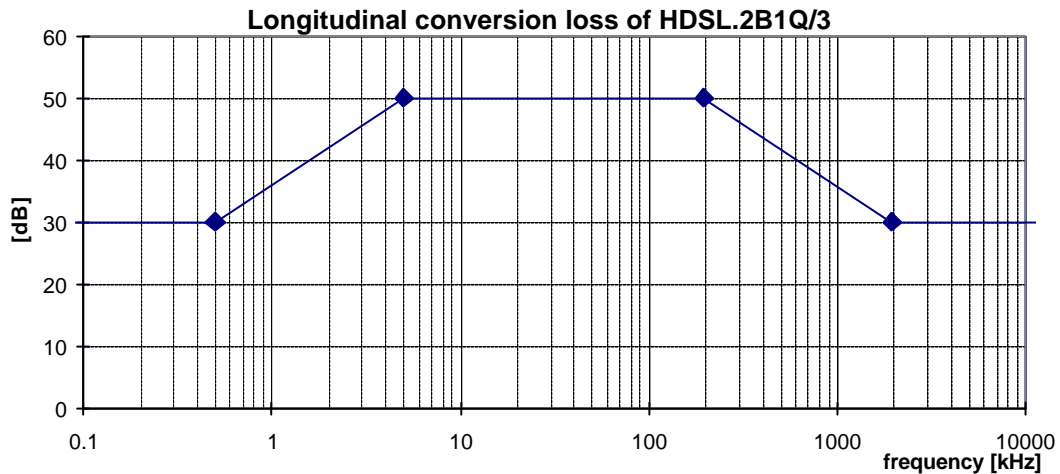

Figure 11: Minimum longitudinal conversion loss for a HDSL.2B1Q/3 signal source (392 kbaud/wirepair)

Frequency	LCL
<0.5 kHz	30 dB
5 kHz	50 dB
196 kHz	50 dB
1960 kHz	30 dB
30000 kHz	30 dB

Table 18: Frequencies and LCL values of the breakpoints of the LCL mask in figure 11.

8.1.5. Feeding Power (from the LT-port)

To be compliant with this signal category, the DC feeding voltage and feeding current, used for the HDSL service shall not exceed the maximum values in table 19. The value for power includes a possible overload or short circuit condition at the user-network interface.

Reference [9]: [ETSI TS 101 135: clause 9.2]

Voltage	Current
SUM (DC feeding + AC signal)	
maximum 120 V	50 mA

Table 19 Maximum feeding requirements for the leased line service over HDSL

8.2. "HDSL.2B1Q/2" Signals (584 kbaud leased lines)

This category covers signals, generated by HDSL transmission equipment on two wire-pairs, based on 2B1Q line coding. This sub clause is based on the ETSI reports on HDSL equipment [9]. These are essentially 584 kbaud systems (per wire-pair)

A signal (per wire-pair) can be classified as an "HDSL.2B1Q/2 signal" if it is compliant with all subclauses below. Unless otherwise indicated, the following signal specifications apply with a resistive load impedance of 135 Ω , and does not apply to the DC remote power feeding (if any).

8.2.1. Total signal power

To be compliant with this signal category, the mean signal power into a resistive load of 135 Ω shall not exceed a level of 14 dBm, measured within a frequency band from at least 100 Hz to 1168 kHz.

Reference [9]: [ETSI TS 101 135: clause 5.8.4.4]

8.2.2. Peak amplitude

To be compliant with this signal category, the nominal voltage peak of the largest signal pulse into a resistive load of 135 Ω shall not exceed a level of 2,64 V ($\pm 7\%$), measured within a frequency band from at least 100 Hz to 1168 kHz.

Reference [9]: [ETSI TS 101 135: clause 5.8.4.1]

8.2.3. Narrow-band signal power

To be compliant with this signal category, the narrow-band signal power (NBSP) into a resistive load impedance R , shall not exceed the limits given in table 20, at any point in the frequency range 100 Hz to 30 MHz. This table specifies the break points of these limits. Limits for intermediate frequencies can be found by drawing a straight line between the break points on a logarithmic (Hz) - linear (dB) scale. Figure 12 illustrates the NBSP in a bandwidth-normalised way.

The NBSP is the average power P of a sending signal into a load resistance R , within a power bandwidth B . The measurement method of the NBSP is described in sub-clause 12.1.

Reference: [9]: [ETSI TS 101 135: clause 5.8.4.3]. These numbers are reconstructed from PSD requirements in [9]

NOTE The NBSP specification in table 20 is reconstructed from the commonly used PSD specification in [9] (similar to figure 12), and used here since it is much wider applicable. This enables a unified specification method. PSD specifications are adequate when signals are purely random in nature, but cannot cover harmonic components in a signal (would cause infinite high "PSD" levels at these harmonic frequencies). NBSP specifications cover both signal types.

Centre frequency f	Impedance R	Signal Level P	Power bandwidth B	Spectral Power P/B
0,51 kHz	135Ω	-9 dBm	1 kHz	-39 dBm/Hz
10 kHz	135Ω	-9 dBm	1 kHz	-39 dBm/Hz
10 kHz	135Ω	1 dBm	10 kHz	-39 dBm/Hz
292 kHz	135Ω	1 dBm	10 kHz	-39 dBm/Hz
2,92 MHz	135Ω	-79 dBm	10 kHz	-119 dBm/Hz
2,92 MHz	135Ω	-59 dBm	1 MHz	-119 dBm/Hz
30 MHz	135Ω	-59 dBm	1 MHz	-119 dBm/Hz

Table 20: Break points of the narrow-band power limits. These limits are frequency independent between 100 Hz to 292 kHz, and decrease with 24 dB/octave (80 dB/decade) above 292 kHz.

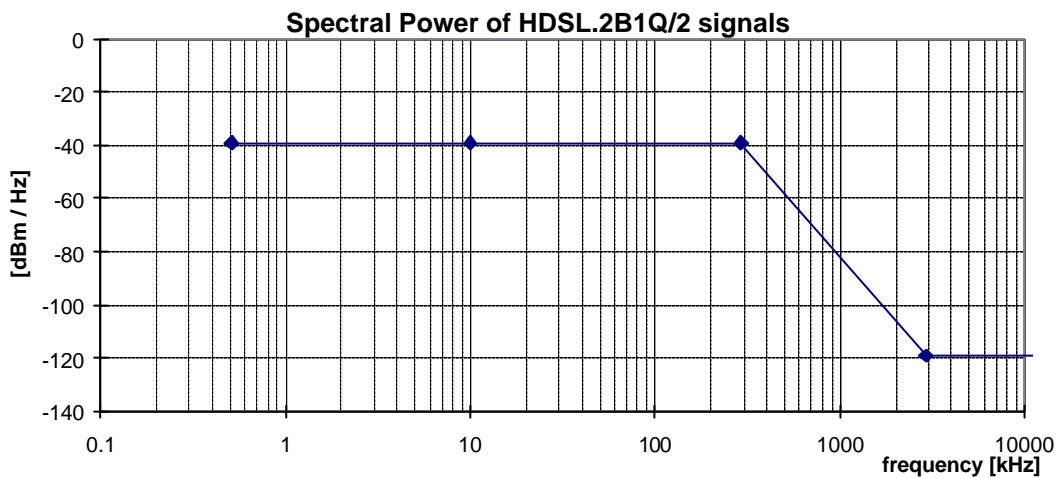

Figure 12: Spectral Power, for HDSL.2B1Q/2 signals, as specified in table 20.

8.2.4. Unbalance about earth

To be compliant with this signal category, the balance of the signal that may flow through the LT-port or NT-port shall exceed minimum requirements, under the condition that the local loop wiring and its termination is well balanced. This can be verified by a longitudinal output voltage (LOV) and a longitudinal conversion loss (LCL) measurement at the source of that signal, as specified in sub-clause 12.2.2 and 12.2.3. The minimum LOV and LCL requirements hold for what can be observed at the ports of the Local Loop Wiring, when the Local Loop Wiring is replaced by an artificial impedance network described in sub-clause 12.2.2 and 12.2.3.

The differential termination impedance for LOV and LCL measurements shall be chosen equally to the design impedance $R_T=135 \Omega$ of the Signal Source under test.

The observed LOV shall have an rms voltage of below the value specified in table 21, measured in a power bandwidth **B**, centred over any frequency in the range from f_{\min} to f_{\max} , and averaged in any one second period. Compliance with this limitation is required with a longitudinal terminating impedance having value $Z_L(\omega)=R_T+1/(j\omega C_L)$ for all frequencies between f_{\min} to f_{\max} . Sub clause 12.2.2 defines an example measurement method for longitudinal output voltage.

The observed LCL shall be higher than the lower limits given in figure 13. The LCL values of the associated break frequencies of this figure are given in table 22. Sub clause 12.2.3 defines an example measurement method for longitudinal conversion loss.

Reference [9]: [ETSI TS 101 135: clause 5.8.5.1] extended to 30 MHz according to Reference[20]:

Reference [20]: [ETSI TS 101 270-1: clause 8.3.3]

LOV	B	f _{min}	f _{max}	R _L	C _L
-46dBV	10 kHz	5,1 kHz	575 kHz	100Ω	150 nF

Table 21: Values for the LOV limits.

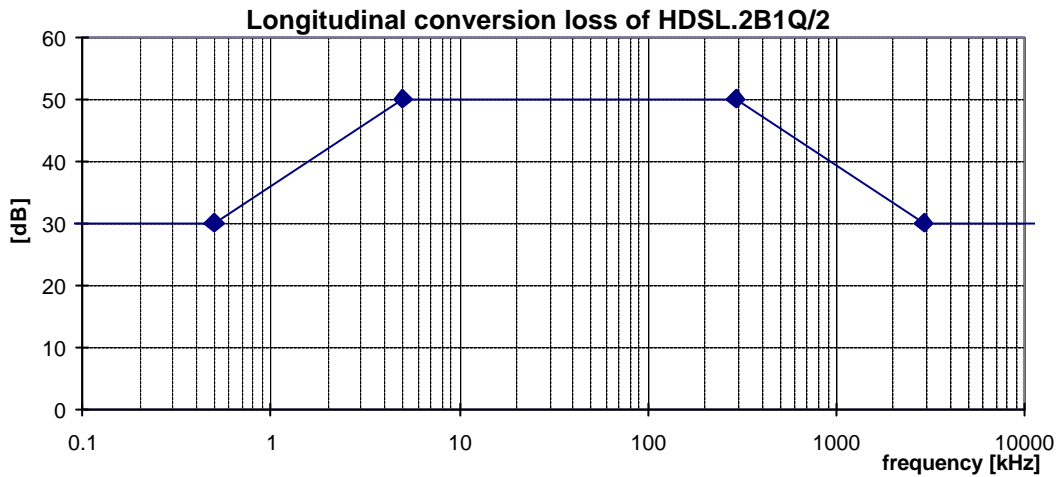

Figure 13: Minimum longitudinal conversion loss for a HDSL.2B1Q/2 signal source (584 kbaud/wirepair)

Frequency	LCL
<0,5 kHz	30 dB
5 kHz	50 dB
292 kHz	50 dB
2920 kHz	30 dB
30000 kHz	30 dB

Table 22: Frequencies and LCL values of the breakpoints of the LCL mask in figure 13.

8.2.5. Feeding Power (from the LT-port)

To be compliant with this signal category, the DC feeding voltage and feeding current, used for the HDSL service shall not exceed the maximum values in table 23. The value for power includes a possible overload or short circuit condition at the user-network interface.

Reference [9]: [ETSI TS 101 135: clause 9.2]

Voltage	Current
SUM (DC feeding + AC signal)	
maximum 120 V	50 mA

Table 23 Maximum feeding requirements for the leased line service over HDSL

8.3. "HDSL.2B1Q/1" Signals (1160 kbaud leased lines)

This category covers signals, generated by HDSL transmission equipment on a single wire-pair, based on 2B1Q line coding. This sub clause is based on the ETSI reports on HDSL equipment [9].

A signal (per wire-pair) can be classified as an "HDSL.2B1Q/1 signal" if it is compliant with all subclauses below. Unless otherwise indicated, the following signal specifications apply with a resistive load impedance of 135 Ω , and does not apply to the DC remote power feeding (if any).

8.3.1. Total signal power

To be compliant with this signal category, the mean signal power into a resistive load of 135 Ω shall not exceed a level of 14 dBm, measured within a frequency band from at least 100 Hz to 2320 kHz.

Reference [9]: [ETSI TS 101 135: clause 5.8.4.4]

8.3.2. Peak amplitude

To be compliant with this signal category, the nominal voltage peak of the largest signal pulse into a resistive load of 135 Ω shall not exceed a level of 2,50 V ($\pm 7\%$), measured within a frequency band from at least 100 Hz to 2320 kHz.

Reference [9]: [ETSI TS 101 135: clause 5.8.4.1]

8.3.3. Narrow-band signal power

To be compliant with this signal category, the narrow-band signal power (NBSP) into a resistive load impedance R , shall not exceed the limits given in table 24, at any point in the frequency range 100 Hz to 30 MHz. This table specifies the break points of these limits. Limits for intermediate frequencies can be found by drawing a straight line between the break points on a logarithmic (Hz) - linear (dB) scale. Figure 14 illustrates the NBSP in a bandwidth-normalised way.

The NBSP is the average power P of a sending signal into a load resistance R , within a power bandwidth B . The measurement method of the NBSP is described in sub-clause 12.1.

NOTE The NBSP specification in table 24 is reconstructed from the commonly used PSD specification in [9] (similar to figure 14), and used here since it is much wider applicable. This enables a unified specification method. PSD specifications are adequate when signals are purely random in nature, but cannot cover harmonic components in a signal (would cause infinite high "PSD" levels at these harmonic frequencies). NBSP specifications cover both signal types.

Reference: [9]: [ETSI TS 101 135: clause 5.8.4.3]. These numbers are reconstructed from PSD requirements in [9]

Centre frequency f	Impedance R	Signal Level P	Power bandwidth B	Spectral Power P/B
0,51 kHz	135 Ω	-11,5 dBm	1 kHz	-41,5 dBm/Hz
10 kHz	135 Ω	-11,5 dBm	1 kHz	-41,5 dBm/Hz
10 kHz	135 Ω	-1,5 dBm	10 kHz	-41,5 dBm/Hz
485 kHz	135 Ω	-1,5 dBm	10 kHz	-41,5 dBm/Hz
4,850 MHz	135 Ω	-81,5 dBm	10 kHz	-121,5 dBm/Hz
4,850 MHz	135 Ω	-61,5 dBm	1 MHz	-121,5 dBm/Hz
30 MHz	135 Ω	-61,5 dBm	1 MHz	-121,5 dBm/Hz

Table 24: Break points of the narrow-band power limits. These limits are frequency independent between 100 Hz to 485 kHz, and decrease with 24 dB/octave (80 dB/decade) above 485 kHz.

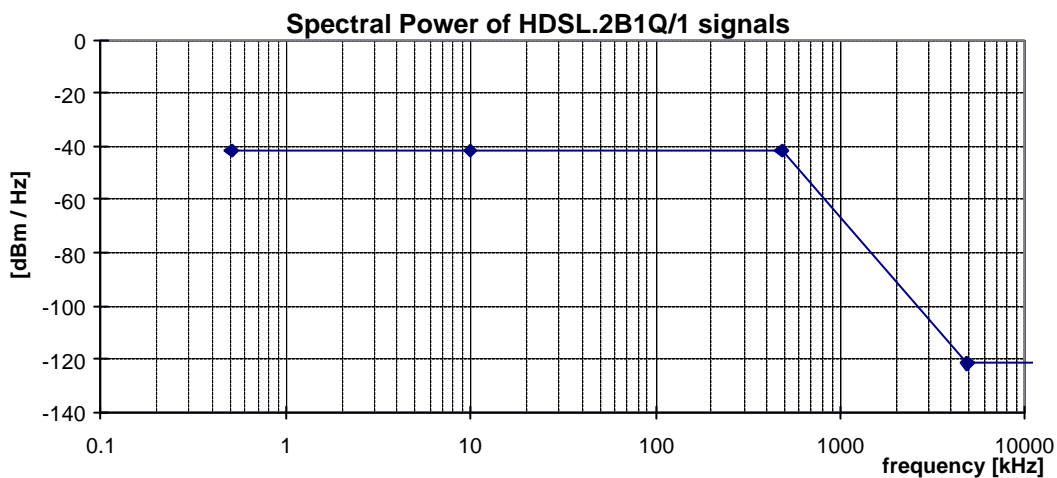

Figure 14: Spectral Power, for HDSL.2B1Q/1 signals, as specified in table 24.

8.3.4. Unbalance about earth

To be compliant with this signal category, the balance of the signal that may flow through the LT-port or NT-port shall exceed minimum requirements, under the condition that the local loop wiring and its termination is well balanced. This can be verified by a longitudinal output voltage (LOV) and a longitudinal conversion loss (LCL) measurement at the source of that signal, as specified in sub-clause 12.2.2 and 12.2.3. The minimum LOV and LCL requirements hold for what can be observed at the ports of the Local Loop Wiring, when the Local Loop Wiring is replaced by an artificial impedance network described in sub-clause 12.2.2 and 12.2.3.

The differential termination impedance for LOV and LCL measurements shall be chosen equally to the design impedance $R_T=135\ \Omega$ of the Signal Source under test.

The observed LOV shall have an rms voltage of below the value specified in table 25, measured in a power bandwidth B , centred over any frequency in the range from f_{\min} to f_{\max} , and averaged in any one second period. Compliance with this limitation is required with a longitudinal terminating impedance having value $Z_L(\omega)=R_L+1/(j\omega C_L)$ for all frequencies between f_{\min} to f_{\max} . Sub clause 12.2.2 defines an example measurement method for longitudinal output voltage.

The observed LCL shall be higher than the lower limits given in figure 15. The LCL values of the associated break frequencies of this figure are given in table 26. Sub clause 12.2.3 defines an example measurement method for longitudinal conversion loss.

Reference [9]: [ETSI TS 101 135: clause 5.8.5.1] extended to 30 MHz according to Reference[20]:
 Reference [20]: [ETSI TS 101 270-1: clause 8.3.3]

LOV	B	f _{min}	f _{max}	R _L	C _L
-46dBV	10 kHz	5,1 kHz	890 kHz	100Ω	150 nF

Table 25: Values for the LOV limits.

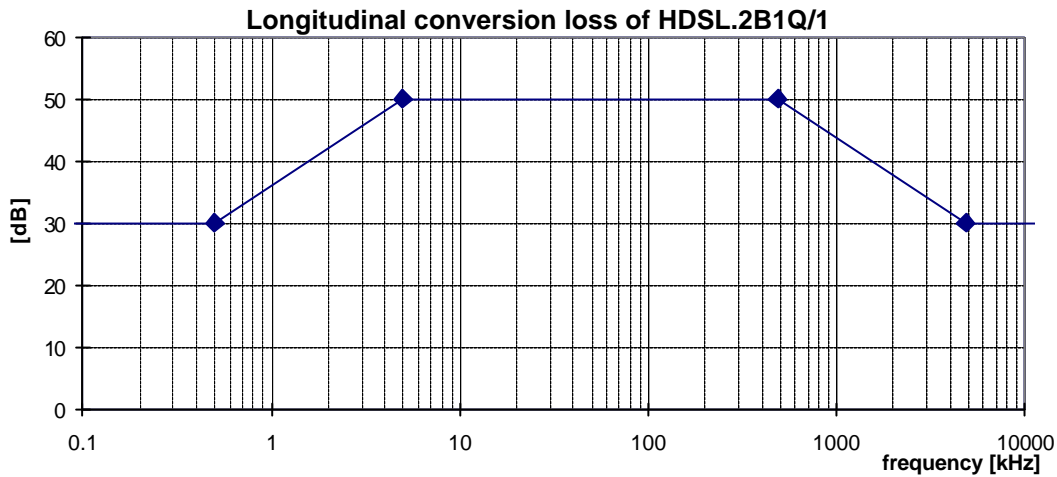

Figure 15:

Minimum longitudinal conversion loss for a HDSL.2B1Q/1 signal source

Frequency	LCL
<0,5 kHz	30 dB
5 kHz	50 dB
485 kHz	50 dB
4850 kHz	30 dB
30000 kHz	30 dB

Table 26: Frequencies and LCL values of the breakpoints of the LCL mask in figure 15.

8.3.5. Feeding Power (from the LT-port)

To be compliant with this signal category, the DC feeding voltage and feeding current, used for the HDSL service shall not exceed the maximum values in table 27. The value for power includes a possible overload or short circuit condition at the user-network interface.

Reference [9]: [ETSI TS 101 135: clause 9.2]

Voltage	Current
SUM (DC feeding + AC signal)	
maximum 120 V	50 mA

Table 27 Maximum feeding requirements for the leased line service over HDSL

8.4. "HDSL.CAP/2" Signals

This category covers signals, generated by HDSL transmission equipment on two wire-pairs, based on CAP modulation. This sub clause is based on the ETSI reports on HDSL equipment [9].

A signal (per wire-pair) can be classified as an "HDSL.CAP/2 signal" if it is compliant with all subclauses below. Unless otherwise indicated, the following signal specifications apply with a resistive load impedance of 135Ω , and does not apply to the DC remote power feeding (if any).

8.4.1. Total signal power

To be compliant with this signal category, the mean signal power into a resistive load of 135Ω shall not exceed a level of 14 dBm, measured within a frequency band from at least 100 Hz to 1 MHz.

Reference [9]: [ETSI TS 101 135: clause B.5.8.4.1]

8.4.2. Peak amplitude

To be compliant with this signal category, the nominal voltage peak of the largest signal pulse into a resistive load of 135Ω shall not exceed a level of 6,5V (13V peak-peak), measured within a frequency band from at least 100 Hz to 1 MHz.

(no ETSI reference)

8.4.3. Narrow-band signal power (NBSP)

To be compliant with this signal category, the narrow-band signal power (NBSP) into a resistive load impedance R , shall not exceed the limits given in table 28, at any point in the frequency range 100 Hz to 30 MHz. This table specifies the break points of these limits. Limits for intermediate frequencies can be found by drawing a straight line between the break points on a logarithmic (Hz) - linear (dB) scale. Figure 16 illustrates the NBSP in a bandwidth-normalised way.

The NBSP is the average power P of a sending signal into a load resistance R , within a power bandwidth B . The measurement method of the NBSP is described in sub-clause 12.1.

NOTE The NBSP specification in table 28 is reconstructed from the commonly used PSD specification in [9] (similar to figure 16), and used here since it is much wider applicable. This enables a unified specification method. PSD specifications are adequate when signals are purely random in nature, but cannot cover harmonic components in a signal (would cause infinite high "PSD" levels at these harmonic frequencies). NBSP specifications cover both signal types. The NBSP specification of this signal category has been split into two overlapping limits. Both upper limits shall be met simultaneously. The 10 kHz bandwidth values represent the "maximum PSD values" from [9], while the 100 kHz bandwidth values represent the "nominal PSD values". The 100 kHz bandwidth specification has been added here to smooth spectral ripple (" $\pm 1,5$ dB") from the "maximum PSD" into the "nominal PSD".

Reference [9]: [ETSI TS 101 135: clause B.5.8.4.2]. (reconstructed from the PSD requirements in [9])

Centre frequency f	Impedance R	Signal Level P	Power bandwidth B	Spectral Power P/B	
0,51 kHz	135Ω	-25,5 dBm	1 kHz	-55,5 dBm/Hz	A
3,98 kHz	135Ω	-25,5 dBm	1 kHz	-55,5 dBm/Hz	
3,98 kHz	135Ω	-15,5 dBm	10 kHz	-55,5 dBm/Hz	
21,50 kHz	135Ω	-1,5 dBm	10 kHz	-41,5 dBm/Hz	
39,02 kHz	135Ω	+1,5 dBm	10 kHz	-38,5 dBm/Hz	
237,58 kHz	135Ω	+1,5 dBm	10 kHz	-38,5 dBm/Hz	
255,10 kHz	135Ω	-1,5 dBm	10 kHz	-41,5 dBm/Hz	
272,62 kHz	135Ω	-17 dBm	10 kHz	-57 dBm/Hz	
297,00 kHz	135Ω	-30 dBm	10 kHz	-70 dBm/Hz	
1,188 MHz	135Ω	-80 dBm	10 kHz	-120 dBm/Hz	
1,188 MHz	135Ω	-60 dBm	1 MHz	-120 dBm/Hz	
30 MHz	135Ω	-60 dBm	1 MHz	-120 dBm/Hz	
30 kHz	135Ω	+10 dBm	100 kHz	-40 dBm/Hz	B
250 kHz	135Ω	+10 dBm	100 kHz	-40 dBm/Hz	

Table 28: Frequencies of the break points and the corresponding peak and average values of the narrow-band signal power.

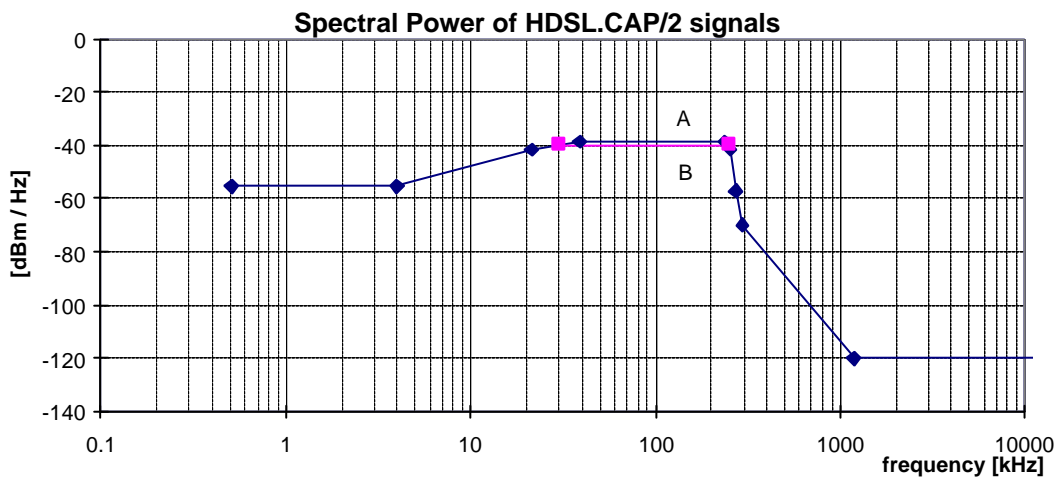

Figure 16: Spectral Power, for HDSL.CAP/2 signals, as specified in table 28.

8.4.4. Unbalance about earth

To be compliant with this signal category, the balance of the signal that may flow through the LT-port or NT-port shall exceed minimum requirements, under the condition that the local loop wiring and its termination is well balanced. This can be verified by a longitudinal output voltage (LOV) and a longitudinal conversion loss (LCL) measurement at the source of that signal, as specified in sub-clause 12.2.2 and 12.2.3. The minimum LOV and LCL requirements hold for what can be observed at the ports of the Local Loop Wiring, when the Local Loop Wiring is replaced by an artificial impedance network described in sub-clause 12.2.2 and 12.2.3.

The differential termination impedance for LOV and LCL measurements shall be chosen equally to the design impedance $R_T=135\ \Omega$ of the Signal Source under test.

The observed LOV shall have an rms voltage of below the value specified in table 29, measured in a power bandwidth **B**, centred over any frequency in the range from f_{\min} to f_{\max} , and averaged in any one second period. Compliance with this

limitation is required with a longitudinal terminating impedance having value $Z_L(\omega)=R_L+1/(j\omega C_L)$ for all frequencies between f_{\min} to f_{\max} . Sub clause 12.2.2 defines an example measurement method for longitudinal output voltage.

The observed LCL shall be higher than the lower limits given in figure 17. The LCL values of the associated break frequencies of this figure are given in table 30. Sub clause 12.2.3 defines an example measurement method for longitudinal conversion loss.

Reference [9]: [ETSI TS 101 135: clause B.5.8.5.1] extended to 30 MHz according to Reference[20]:

Reference [20]: [ETSI TS 101 270-1: clause 8.3.3]

LOV	B	f_{\min}	f_{\max}	R_L	C_L
-46dBV	10 kHz	5,1 kHz	285 kHz	100 Ω	150 nF

Table 29: Values for the LOV limits.

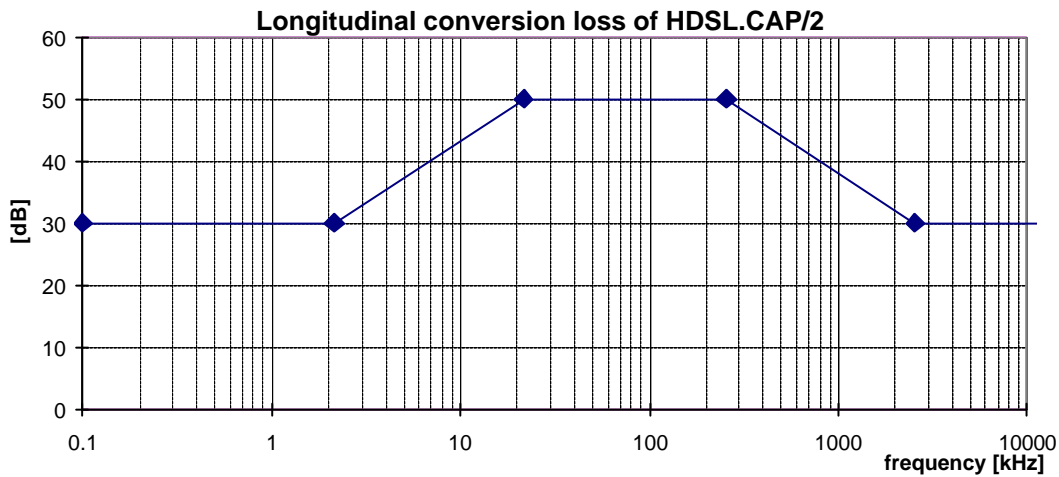

Figure 17: Minimum longitudinal conversion loss.

Frequency	LCL
<2,15 kHz	30 dB
21,5 kHz	50 dB
255 kHz	50 dB
2550 kHz	30 dB
30000 kHz	30 dB

Table 30: Frequencies and LCL values of the breakpoints of the LCL mask in figure 17.

8.4.5. Feeding Power (from the LT-port)

To be compliant with this signal category, the DC feeding voltage and feeding current, used for the HDSL service shall not exceed the maximum values in table 31. The value for power includes a possible overload or short circuit condition at the user-network interface.

Reference [9]: [ETSI TS 101 135: clause 9.2]

Voltage	Current
SUM (DC feeding + AC signal)	
maximum 120 V	50 mA

Table 31 Maximum feeding requirements for the leased line service over HDSL

8.5. "SDSL" Signals

This category covers Symmetrical DSL transmission equipment on a single wire-pair.

The signals that will be generated by SDSL equipment are currently under study, within the ETSI-TM6 SDSL project. When that study has been completed, the description of the agreed signal will be included here.

Reference [10]: [ETSI WG TM6(98)8, Draft Part 1: Functional requirements]

8.6. "Proprietary.SymDSL.CAP.A::Fn" Signals

This category covers signals, generated by Proprietary multi-rate SymDSL transmission equipment on one (or two) wire-pairs. This signal is labelled as *Proprietary*, since it is not covered by ETSI, ITU nor ANSI product standards.

This signal definition is linecode independent, but dedicated to signals from transmission equipment for variable bit-rate leased lines that are using CAP modulation. These definitions are partly based on the ETSI specifications on HDSL equipment [9].

In the naming convention "Proprietary.SymDSL.CAP.A::Fn", is the phrase "Fn" a placeholder for a number that is used as parameter F_N in the signal definition. Replacing "Fn" in the signal name by a value, changes the generic signal description into a specific description, since its value is required in the sub clauses below. It is referred to as the *Principal frequency* of the signal.

The Principal frequency F_N is indicative for the maximum symbol rate [kbaud] that can be transported within these signal limits. A signal with a higher Principal Frequency occupies a wider spectrum. Values between 72 kHz and 387 kHz are commonly used.

Table 32 gives several examples on how to use the naming convention for specifying the actual parameter value F_N . It also illustrates some (informative) bitrates that can be transported within these signal limits, when using the associated (informative) modulation parameters. These are examples only, other system implementations may use the same signal limits in a different way.

Signal category	F_N [kHz]	Baud Rate [kbaud]	Bit Rate [kb/s]	Bit/Symbol	Constellation size
Proprietary.SymDSL.CAP.A::72	72 kHz	72	144	2	8
Proprietary.SymDSL.CAP.A::91	91 kHz	91	272	3	16
Proprietary.SymDSL.CAP.A::133	133 kHz	133	400	3	16
Proprietary.SymDSL.CAP.A::176	176 kHz	176	528	3	16
Proprietary.SymDSL.CAP.A::261	261 kHz	261	784	3	16
Proprietary.SymDSL.CAP.A::261	261 kHz	261	1040	4	32
Proprietary.SymDSL.CAP.A::311	311 kHz	311	1552	5	64
Proprietary.SymDSL.CAP.A::344	344 kHz	344	2064	6	128
Proprietary.SymDSL.CAP.A::387	387 kHz	387	2320	6	128

Table 32: Example on how the naming convention relates to the actual parameter value F_N that is used in the subclauses below to specify the signal limits of this signal category. The bitrates and modulation parameters are informative only, and implementation dependent.

A signal (per wire-pair) can be classified as a "Proprietary.SymDSL.CAP.A::Fn" signal if it is compliant with all subclauses below, and if parameter "Fn" is specified by a numerical value.

Unless otherwise indicated, the following signal specifications apply with a resistive load impedance of 135Ω , and does not apply to the DC remote power feeding (if any).

8.6.1. Total signal power

To be compliant with this signal category, the mean signal power into a resistive load of 135Ω shall not exceed a level of 14 dBm, measured within a frequency band from at least 100 Hz to 1 MHz.

(no ETSI reference)

8.6.2. Peak amplitude

To be compliant with this signal category, the nominal voltage peak of the largest signal pulse into a resistive load of 135Ω shall not exceed a level of 6,5V (13V peak-peak), measured within a frequency band from at least 100 Hz to 1 MHz.

(no ETSI reference)

8.6.3. Narrow-band signal power (NBSP)

To be compliant with this signal category, the narrow-band signal power (NBSP) into a resistive load impedance R , shall not exceed the limits given in table 33, at any point in the frequency range 100 Hz to 30 MHz. This table specifies the break points of these limits. Limits for intermediate frequencies can be found by drawing a straight line between the break points on a logarithmic (Hz) - linear (dB) scale. Figure 18 illustrates the NBSP in a bandwidth-normalised way.

The NBSP is the average power P of a sending signal into a load resistance R , within a power bandwidth B . The measurement method of the NBSP is described in sub-clause 12.1.

(no ETSI reference)

Centre frequency f	Impedance R	Signal Level P	Power bandwidth B	Spectral Power P/B
0,1 kHz	135Ω	-50 dBm	100 Hz	-70 dBm/Hz
4 kHz	135Ω	-39 dBm	100 Hz	-59 dBm/Hz
4 kHz	135Ω	-29 dBm	1 kHz	-59 dBm/Hz
10 kHz	135Ω	-12 dBm	1 kHz	-42 dBm/Hz
10 kHz	135Ω	-12 dBm	1 kHz	-42 dBm/Hz
40 kHz	135Ω	-9 dBm	1 kHz	-39 dBm/Hz
$F_L + F_N$	135Ω	-9 dBm	1 kHz	-39 dBm/Hz
$F_L + (1+\alpha/2) \times F_N$	135Ω	-12 dBm	1 kHz	-42 dBm/Hz
$F_L + (1+\alpha) \times F_N$	135Ω	-29 dBm	1 kHz	-59 dBm/Hz
500 kHz	135Ω	-46 dBm	1 kHz	-76 dBm/Hz
2 MHz	135Ω	-90 dBm	1 kHz	-120 dBm/Hz
2 MHz	135Ω	-80 dBm	10 kHz	-120 dBm/Hz
30 MHz	135Ω	-80 dBm	10 kHz	-120 dBm/Hz

Table 33: Break points of the narrow-band signal power P , as a function of the Principal frequency F_N of the signal category (see table 32). The parameter values for F_L , and α are defined as $F_L=10$ kHz, and $\alpha=0,15$.

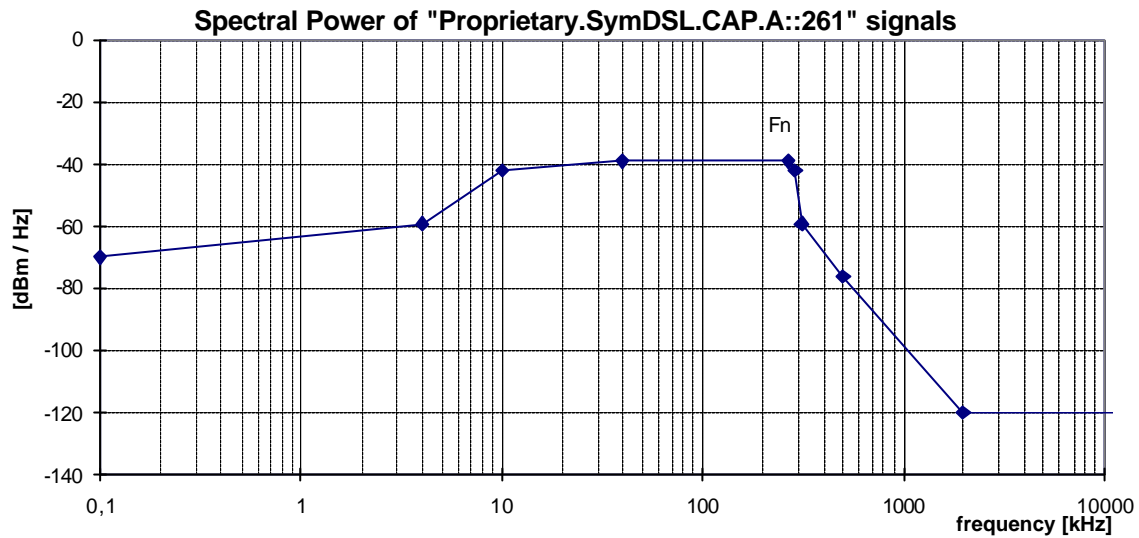

Figure 18: Spectral Power, for "Proprietary.SymDSL.CAP.A::261" signals (at $F_N=261$ kHz), as specified in table 33. Note that these curves are dependent on the Principal frequency F_N , and that this figure shows an example only.

8.6.4. Unbalance about earth

To be compliant with this signal category, the balance of the signal that may flow through the LT-port or NT-port shall exceed minimum requirements, under the condition that the local loop wiring and its termination is well balanced. This can be verified by a longitudinal output voltage (LOV) and a longitudinal conversion loss (LCL) measurement at the source of that signal, as specified in sub-clause 12.2.2 and 12.2.3. The minimum LOV and LCL requirements hold for what can be observed at the ports of the Local Loop Wiring, when the Local Loop Wiring is replaced by an artificial impedance network described in sub-clause 12.2.2 and 12.2.3.

The differential termination impedance for LOV and LCL measurements shall be chosen equally to the design impedance $R_T=135 \Omega$ of the Signal Source under test.

The observed LOV shall have an rms voltage of below the value specified in table 34, measured in a power bandwidth B , centred over any frequency in the range from f_{\min} to f_{\max} , and averaged in any one second period. Compliance with this limitation is required with a longitudinal terminating impedance having value $Z_L(\omega)=R_L+1/(j\omega C_L)$ for all frequencies between f_{\min} to f_{\max} . Sub clause 12.2.2 defines an example measurement method for longitudinal output voltage.

The observed LCL shall be higher than the lower limits given in figure 19. The LCL values of the associated break frequencies of this figure are given in table 35. Sub clause 12.2.3 defines an example measurement method for longitudinal conversion loss.

(no ETSI reference)

LOV	B	f_{\min}	f_{\max}	R_L	C_L
-46dBV	10 kHz	5,1 kHz	500 kHz	100 Ω	150 nF

Table 34: Values for the LOV limits.

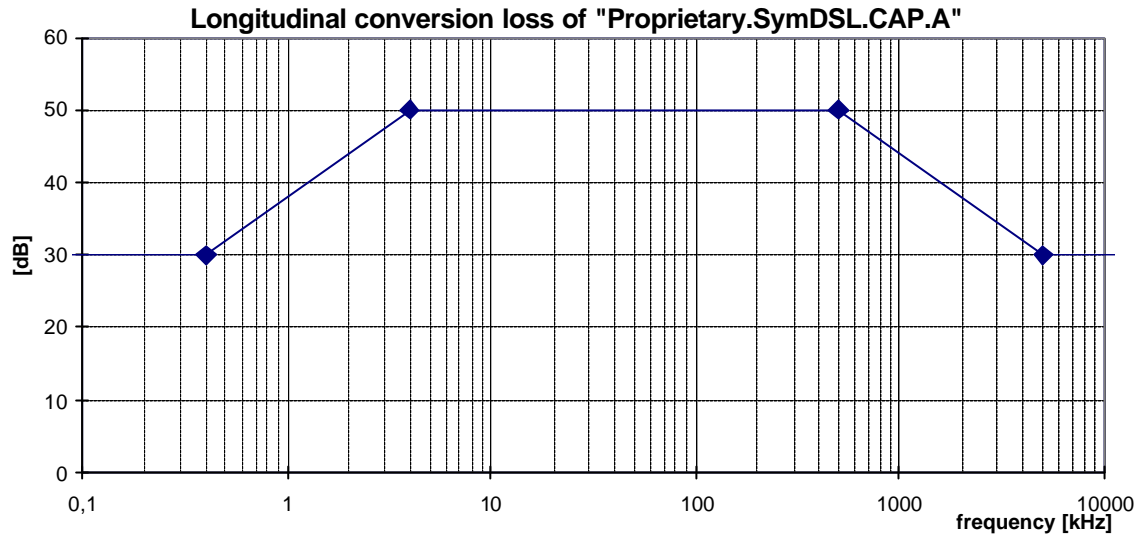

Figure 19: Minimum longitudinal conversion loss for a "Proprietary.SymDSL.CAP.A::261" signal source.

Frequency	LCL
<0,4 kHz	30 dB
4 kHz	50 dB
500 kHz	50 dB
5 MHz	30 dB
30 MHz	30 dB

Table 35: Frequencies and LCL values of the breakpoints of the LCL mask in figure 19.

8.7. "Proprietary.SymDSL.CAP.B::Fn" Signals

This category covers signals, generated by Proprietary multi-rate SymDSL transmission equipment. This signal is labelled as *proprietary*, since it is not covered by ETSI, ITU nor ANSI product standards.

The pass-band signal definition is linecode independent, but derived from CAP based HDSL signals defined in Annex B of [9]. Their definition is driven by the deployment of proprietary multi-rate symmetric HDSL transmission equipment based on CAP modulation. This category covers other CAP implementation than covered by "Proprietary.SymDSL.CAP.A" signals, without significant advantages or disadvantages.

In the naming convention "Proprietary.SymDSL.CAP.B::Fn", is the phrase "Fn" a placeholder for a number that is used as parameter F_N in the signal definition. Replacing "Fn" in the signal name by a value, changes the generic signal description into a specific description, since its value is required in the sub clauses below. It is referred to as the *Principal frequency* of the signal.

The Principal frequency F_N is indicative for the maximum symbol rate [kbaud] that can be transported within these signal limits. A signal with a higher Principal Frequency occupies a wider spectrum. Values between 72 kHz and 387 kHz are commonly used.

Table 36 gives several examples on how to use the naming convention for specifying the actual parameter value F_n . It also illustrates some (informative) bitrates that can be transported within these signal limits, when using the associated (informative) modulation parameters. These are examples only, other system implementations may use the same signal limits in a different way.

Signal category	F_N [kHz]	Symbol Rate [kBaud]	Bits per Symbol	Bit Rate [kb/s]	Constellation size
Propriety.SymDSL.CAP.B::72	72 kHz	72	4	288	32
Propriety.SymDSL.CAP.B::100	100 kHz	100	4	400	32
Propriety.SymDSL.CAP.B::132	132 kHz	132	4	528	32
Propriety.SymDSL.CAP.B::196	196 kHz	196	4	784	32
Propriety.SymDSL.CAP.B::208	208 kHz	208	5	1040	64
Propriety.SymDSL.CAP.B::310	311 kHz	310,4	5	1552	64
Propriety.SymDSL.CAP.B::344	344 kHz	344	6	2064	128
Propriety.SymDSL.CAP.B::387	387 kHz	386,7	6	2320	128

Table 36: Example on how the naming convention relates to the actual parameter value F_N that is used in the subclauses below to specify the signal limits of this signal category. The bitrates and modulation parameters are informative only, and implementation dependent.

A signal (per wire-pair) can be classified as a "Proprietary.SymDSL.CAP.B:: F_N " signal if it is compliant with all subclauses below, and if parameter " F_N " is specified by a numerical value.

Unless otherwise indicated, the following signal specifications apply with a resistive load impedance of 135 Ω , and does not apply to the DC remote power feeding (if any).

8.7.1. Total signal power

To be compliant with this signal category, the mean signal power into a resistive load of 135 Ω shall not exceed a level of 14 dBm, measured within a frequency band from at least 100 Hz to 1 MHz.

(no ETSI reference)

8.7.2. Peak amplitude

To be compliant with this signal category, the nominal voltage peak of the largest signal pulse into a resistive load of 135 Ω shall not exceed a level of 7,4V measured within a frequency band from at least 100 Hz to 1 MHz.

(no ETSI reference)

8.7.3. Narrow-band signal power (NBSP)

To be compliant with this signal category, the narrow-band signal power (NBSP) into a resistive load impedance R , shall not exceed the limits given in table 37, at any point in the frequency range 100 Hz to 30 MHz. This table specifies the break points of these limits. Limits for intermediate frequencies can be found by drawing a straight line between the break points on a logarithmic (Hz) - linear (dB) scale. Figure 20 illustrates the NBSP in a bandwidth-normalised way.

The NBSP is the average power P of a sending signal into a load resistance R , within a power bandwidth B . The measurement method of the NBSP is described in sub-clause 12.1.

(no ETSI reference)

Centre frequency f	Impedance R	Signal Level P	Power bandwidth B	Spectral Power P/B
0,1 kHz	135Ω	A-37 dBm	100 Hz	A-17 dBm/Hz
4 kHz	135Ω	A-37 dBm	100 Hz	A-17 dBm/Hz
4 kHz	135Ω	A-47 dBm	1 kHz	A-17 dBm/Hz
9 kHz	135Ω	A-30 dBm	1 kHz	A dBm/Hz
$F_L + F_N$	135Ω	A-30 dBm	1 kHz	A dBm/Hz
$F_L + (1+\alpha/2) \times F_N$	135Ω	A-33 dBm	1 kHz	A-3 dBm/Hz
$F_L + (1+\alpha) \times F_N$	135Ω	A-50 dBm	1 kHz	A-20 dBm/Hz
500 kHz	135Ω	-46 dBm	1 kHz	-76 dBm/Hz
2 MHz	135Ω	-90 dBm	1 kHz	-120 dBm/Hz
2 MHz	135Ω	-80 dBm	10 kHz	-120 dBm/Hz
30 MHz	135Ω	-80 dBm	10 kHz	-120 dBm/Hz
$F_L=10$ kHz $a=0,15$ $A=13,5 - 10 \times \log_{10}(F_N/F_0)+1$ dBm/Hz $F_0=1$ Hz				

Table 37: Break points of the narrow-band signal power P , as a function of the Principal frequency F_N of the signal category (see table 36).

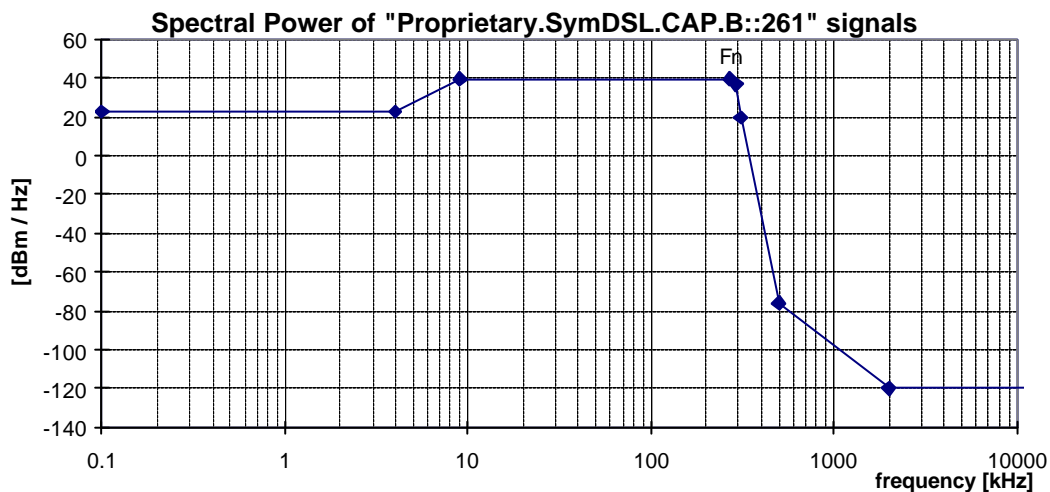

Figure 20: Spectral Power, for "Proprietary.SymDSL.CAP.B::261" signals (at $F_N=261$ kHz), as specified in table 37. Note that these curves are dependent on the Principal frequency F_N , and that this figure shows an example only.

8.7.4. Unbalance about earth

To be compliant with this signal category, the balance of the signal that may flow through the LT-port or NT-port shall exceed minimum requirements, under the condition that the local loop wiring and its termination is well balanced. This can be verified by a longitudinal output voltage (LOV) and a longitudinal conversion loss (LCL) measurement at the source of that signal, as specified in sub-clause 12.2.2 and 12.2.3. The minimum LOV and LCL requirements hold for what can be observed at the ports of the Local Loop Wiring, when the Local Loop Wiring is replaced by an artificial impedance network described in sub-clause 12.2.2 and 12.2.3.

The differential termination impedance for LOV and LCL measurements shall be chosen equally to the design impedance $R_T=135 \Omega$ of the Signal Source under test.

The observed LOV shall have an rms voltage of below the value specified in table 38, measured in a power bandwidth B , centred over any frequency in the range from f_{min} to f_{max} , and averaged in any one second period. Compliance with this limitation is required with a longitudinal terminating impedance having value $Z_L(\omega)=R_L+1/(j\omega C_L)$ for all frequencies between f_{min} to f_{max} . Sub clause 12.2.2 defines an example measurement method for longitudinal output voltage.

The observed LCL shall be higher than the lower limits given in figure 21. The LCL values of the associated break frequencies of this figure are given in table 39. Sub clause 12.2.3 defines an example measurement method for longitudinal conversion loss.

(no ETSI reference)

LOV	B	f_{min}	f_{max}	R_L	C_L
-46dBV	10 kHz	5,1 kHz	500 kHz	100Ω	150 nF

Table 38: Values for the LOV limits.

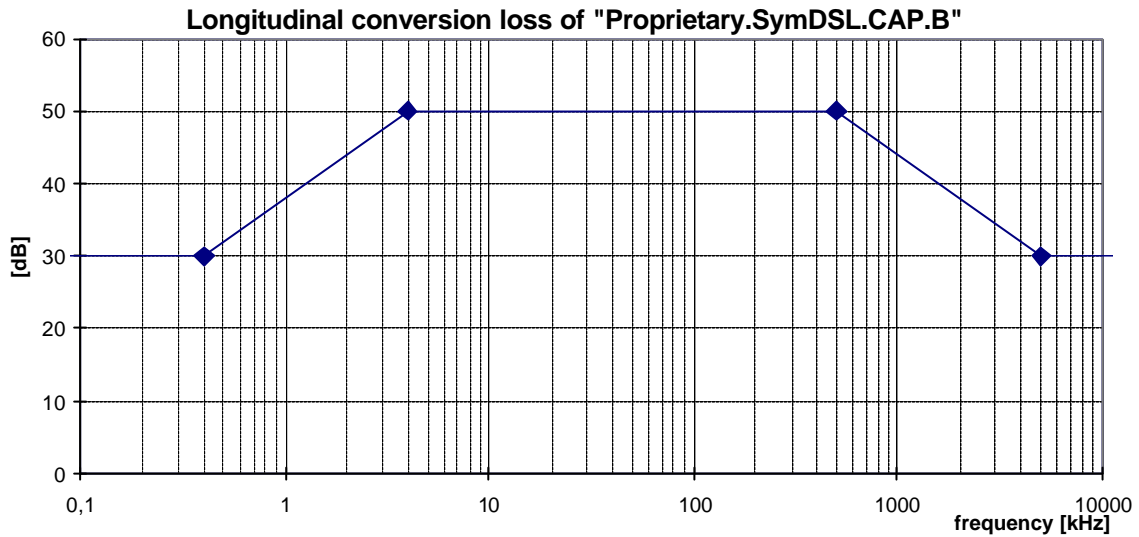

Figure 21: Minimum longitudinal conversion loss for a "Proprietary.SymDSL.CAP.B::261" signal source.

Frequency	LCL
<0, kHz	30 dB
4 kHz	50 dB
500 kHz	50 dB
5 MHz	30 dB
30 MHz	30 dB

Table 39: Frequencies and LCL values of the breakpoints of the LCL mask in figure 21.

8.8. "Proprietary.SymDSL.PAM::Fn" Signals

This category covers signals, generated by Proprietary multi-rate SymDSL transmission equipment on a single wire pair. This signal is labelled as *Proprietary*, since it is not covered by ETSI, ITU nor ANSI product standards.

This signal definition is linecode independent, but dedicated to signals from transmission equipment that are using PAM modulation.

In the naming convention "Proprietary.SymDSL.PAM::Fn", is the phrase "Fn" a placeholder for a number that is used as parameter F_N in the signal definition. Replacing "Fn" in the signal name by a value, changes the generic signal description into a specific description, since its value is required in the sub clauses below. It is referred to as the *Principal frequency* of the signal.

The Principal frequency F_N is indicative for the maximum symbol rate [kbaud] that can be transported within these signal limits. A signal with a higher Principal Frequency occupies a wider spectrum. The subclause below are defined for all Principal frequencies between 80kHz and 264 kHz.

Table 40 gives several examples on how to use the naming convention for specifying the actual parameter value F_n . It also illustrates some (informative) bitrates that can be transported within these signal limits, when using the associated (informative) modulation parameters. These are examples only, other system implementations may use the same signal limits in a different way.

Signal category	F_N [kHz]		Baud Rate [kbaud]	Bit/symbol	Bit Rate [kb/s]
Proprietary.SymDSL.PAM::80	80 kHz		80	2	160
Proprietary.SymDSL.PAM::258	258 kHz		258	4	1032
Proprietary.SymDSL.PAM::264	264 kHz		264	3	792

Table 40: Example on how the naming convention relates to the actual parameter value F_N that is used in the sub clauses below to specify the signal limits of this signal category. The actual bitrates and modulation parameters are implementation dependent, and informative only. They are included here to illustrate that different bitrates can be carried by signals having the same Principal frequency

Two slightly different additional variants are identified for all signals with specified Principal Frequency:

Option A signals, are dedicated to Ungerboeck Coded PAM with 2, 3 or 4 bits per symbol (before encoding)

Option B signals, are dedicated to 2B1Q linecoded signals.

A signal can be classified as a "Proprietary.SymDSL.PAM::Fn" signal if it is compliant with all subclauses below and if parameter "Fn" is specified by a numerical value.

NOTE The narrow band signal power (NBSP) of "Proprietary.SymDSL.PAM::Fn" signals, having a Principal frequency between 80 - 141.3 kHz, also fit under the NBSP mask of ISDN.2B1Q signals. This does not hold for the Peak amplitude and Unbalance about earth, so these signal limits are not 100% compliant with ISDN.2B1Q signals.

8.8.1. Total Signal Power

To be compliant with this signal category, the mean signal power into a resistive load of 135 Ω shall not exceed a level of 14 dBm, measured within a frequency band from at least 100 Hz to $2 \times F_N$.

(no ETSI reference)

8.8.2. Peak amplitude

To be compliant with this signal category, the nominal voltage peak of the largest signal pulse into a resistive load of 135Ω shall not exceed a level of $V_{\text{peak}} (\pm 7\%)$, measured within a frequency band from at least 100 Hz to $F_N \times 2$. Two signal options have been defined, that are different only in their V_{peak} specification:

- For "option A" signals, V_{peak} shall not exceed 3,4 V (6,8 V peak-peak) (*dedicated to Ungerboeck Coded PAM*)
- For "option B" signals, V_{peak} shall not exceed 2,64 V (5,28 V peak-peak) (*dedicated to 2B1Q linecoded signals*)

(no ETSI reference)

8.8.3. Narrow-band signal power (NBSP)

To be compliant with this signal category, the narrow-band signal power (NBSP) into a resistive load impedance R , shall not exceed the limits given in tables 41 and 42, at any point in the frequency range 100 Hz to 30 MHz. Limits for intermediate frequencies can be found by drawing a straight line between the break points on a logarithmic (Hz) - linear (dB) scale. Table 41 describes the break points of these limits in a general way, table 42 specifies the associated parameters for all Principal frequencies between 80 and 264 kHz. Figure 22 illustrates the NBSP in a bandwidth-normalised way.

The NBSP is the average power P of a sending signal into a load resistance R , within a power bandwidth B . The measurement method of the NBSP is described in sub-clause 12.1.

(no ETSI reference)

Centre frequency f	Impedance R	Signal Level P	Power bandwidth B	Spectral Power P/B
0.1 kHz	135 Ω		100 Hz	$SP_1(F_N)$
1 kHz	135 Ω		100 Hz	$SP_1(F_N)$
1 kHz	135 Ω	$P_{1,1k}(F_N)$	1 kHz	$SP_1(F_N)$
10 kHz	135 Ω	$P_{1,1k}(F_N)$	1 kHz	$SP_1(F_N)$
10 kHz	135 Ω	$P_{1,10k}(F_N)$	10 kHz	$SP_1(F_N)$
$F_1(F_N)$	135 Ω	$P_{1,10k}(F_N)$	10 kHz	$SP_1(F_N)$
$F_2(F_N)$	135 Ω	$P_{2,10k}(F_N)$	10 kHz	$SP_2(F_N)$
$F_3(F_N)$	135 Ω	-77 dBm	10 kHz	-117 dBm/Hz
$F_3(F_N)$	135 Ω	-57 dBm	1 MHz	-117 dBm/Hz
30 MHz	135 Ω	-57 dBm	1 MHz	-117 dBm/Hz

Table 41: Break points of the narrow-band signal power P , as a function of the Principal frequency F_N of the signal category (see table 40). The parameter values for $F_1, F_2, F_3, P_{1,1k}, P_{1,10k}, P_{2,10}, SP_1, SP_2$, are defined for each F_N in table 42.

F_N [kHz]	F_1	F_2	F_3	SP_1 [dBm/Hz]	$P_{1,1k}$ [dBm]	$P_{1,10k}$ [dBm]	SP_2 [dBm/Hz]	$P_{2,1k}$ [dBm]	$P_{2,10k}$ [dBm]
80 £ $F_N < 92$	$1/4 \times F_N$	$3/4 \times F_N$	$5,5 \times F_N$	- 30,0	0,0	10	- 38,0	- 8,0	2,0
92 £ $F_N < 104$	$1/4 \times F_N$	$3/4 \times F_N$	$5,5 \times F_N$	- 30,5	-0,5	9,5	- 38,5	- 8,5	1,5
104 £ $F_N < 116$	$1/4 \times F_N$	$3/4 \times F_N$	$5,5 \times F_N$	- 31,0	-1,0	9,0	- 39,0	- 9,0	1,0
116 £ $F_N < 129$	$1/4 \times F_N$	$3/4 \times F_N$	$5 \times F_N$	- 31,5	-1,5	8,5	- 39,5	- 9,5	0,5
129 £ $F_N < 146$	$1/4 \times F_N$	$3/4 \times F_N$	$5 \times F_N$	- 32,0	-2,0	8,0	- 40,0	- 10,0	0,0
146 £ $F_N < 164$	$1/4 \times F_N$	$3/4 \times F_N$	$5 \times F_N$	- 32,5	-2,5	7,5	- 40,5	- 10,5	- 0,5
164 £ $F_N < 185$	$1/4 \times F_N$	$3/4 \times F_N$	$5 \times F_N$	- 33,0	-3,0	7,0	- 41,0	- 11,0	- 1,0
185 £ $F_N < 207$	$1/4 \times F_N$	$2/3 \times F_N$	$4,5 \times F_N$	- 33,5	-3,5	6,5	- 41,5	- 11,5	- 1,5
207 £ $F_N < 232$	$1/4 \times F_N$	$2/3 \times F_N$	$4 \times F_N$	- 34,0	-4,0	6,0	- 42,0	- 12,0	- 2,0
232 £ $F_N < 259$	$1/4 \times F_N$	$2/3 \times F_N$	$3,5 \times F_N$	- 34,5	-4,5	5,5	- 42,5	- 12,5	- 2,5
259 £ F_N £ 264	$1/4 \times F_N$	$2/3 \times F_N$	$3,5 \times F_N$	- 35,0	-5,0	5,0	- 43,0	- 13,0	- 3,0

Table 42: Definition of all Principal-frequency-dependent parameters that are used in table 41, for all Principal frequencies between 80 kHz and 264 kHz.

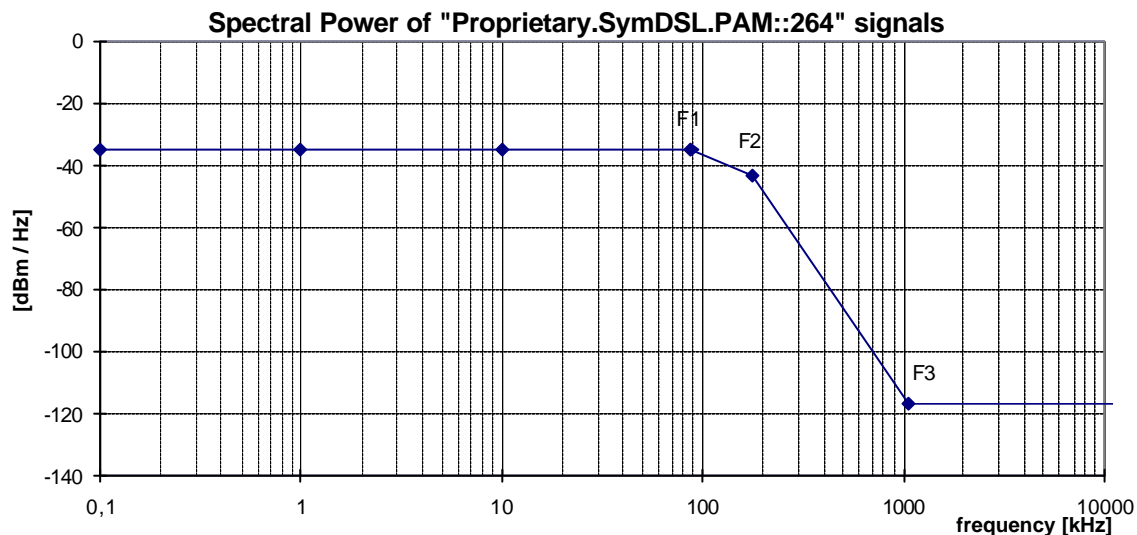

Figure 22: Spectral Power, for "Proprietary.SymDSL.PAM::264" signals (at $F_N=264$ kHz), as specified in table 41 and 42. Note that these curves are dependent on the Principal frequency F_N and that this figure shows an example only.

8.8.4. Unbalance about earth

To be compliant with this signal category, the balance of the signal that may flow through the LT-port or NT-port shall exceed minimum requirements, under the condition that the local loop wiring and its termination is well balanced. This can be verified by a longitudinal output voltage (LOV) and a longitudinal conversion loss (LCL) measurement at the source of that signal, as specified in sub-clause 12.2.2 and 12.2.3. The minimum LOV and LCL requirements hold for what can be observed at the ports of the Local Loop Wiring, when the Local Loop Wiring is replaced by an artificial impedance network described in sub-clause 12.2.2 and 12.2.3.

The differential termination impedance for LOV and LCL measurements shall be chosen equally to the design impedance $R_T=135 \Omega$ of the Signal Source under test.

The observed LOV shall have an rms voltage of below the value specified in table 43, measured in a power bandwidth B , centred over any frequency in the range from f_{\min} to f_{\max} , and averaged in any one second period. Compliance with this

limitation is required with a longitudinal terminating impedance having value $Z_L(\omega)=R_L+1/(j\omega\cdot C_L)$ for all frequencies between f_{\min} to f_{\max} . Sub clause 12.2.2 defines an example measurement method for longitudinal output voltage.

The observed LCL shall be higher than the lower limits given in figure 23. The LCL values of the associated break frequencies of this figure are given in table 44. Sub clause 12.2.3 defines an example measurement method for longitudinal conversion loss.

(no ETSI reference)

LOV	B	f_{\min}	f_{\max}	R_L	C_L
-46dBV	10 kHz	5,1 kHz	500 kHz	100 Ω	150 nF

Table 43: Values for the LOV limits.

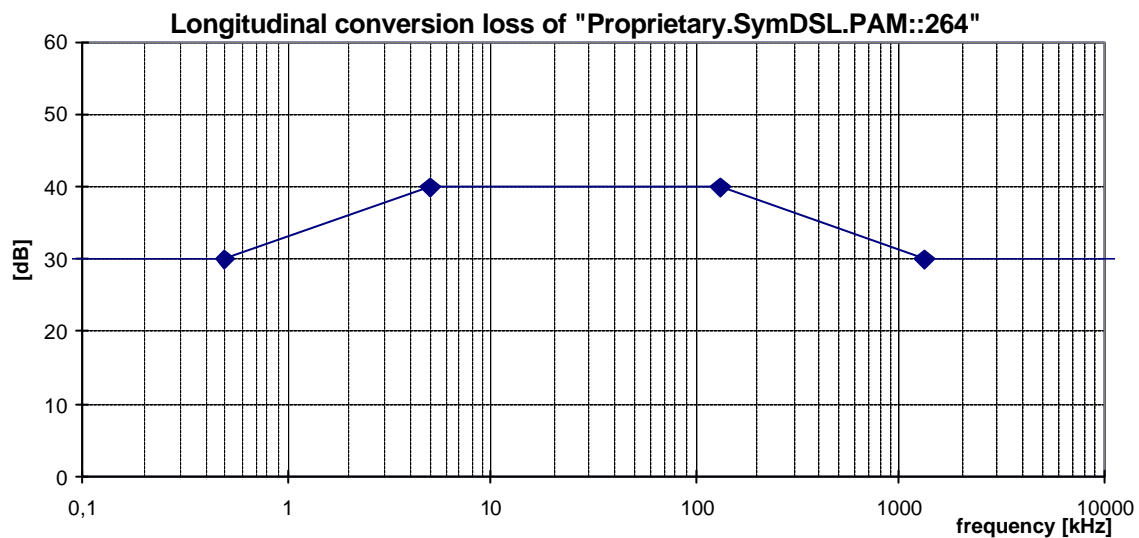

Figure 23: Minimum longitudinal conversion loss for a "Proprietary.SymDSL.PAM::264" signal source.

Frequency	LCL
<0,5 kHz	slope: +20 dB/decade
5 kHz	40 dB
$1/2 \times F_N$	40 dB
$>1/2 \times F_N$	slope: -20 dB/decade

Table 44: Frequencies and LCL values of the breakpoints of the LCL mask in figure 23.

8.8.5. Feeding Power (from the LT-port)

To be compliant with this signal category, the DC feeding voltage and feeding current, used for the MDSL service shall not exceed the maximum values in table 45. The value for power includes a possible overload or short circuit condition at the user-network interface.

Note, the values in table 45 represent values of a typical European application, Other voltage up to 190 V can be supported.

(no ETSI reference)

Voltage	Current	Power NT-Port
Maximum 115V (see EN60950)	Maximum 55 mA	Maximum 1100 mW

Table 45: Maximum feeding requirements for the leased line service over "Proprietary.SymDSL.PAM::Fn"

8.9. "Proprietary.SymDSL.2B1Q::Fn" Signals

This category covers signals, generated by Proprietary multi-rate SymDSL transmission equipment on one, two, or three wire pairs. This signal is labelled as *Proprietary*, since it is not covered by ETSI, ITU nor ANSI product standards.

This signal definition is linecode independent, but dedicated to signals from transmission equipment that are using 2B1Q modulation (4-level PAM). The use of other line codes is not precluded.

In the naming convention " Proprietary.SymDSL.2B1Q::Fn", is the phrase "Fn" a placeholder for a number that is used as parameter F_N in the signal definition. Replacing "Fn" in the signal name by a value, changes the generic signal description into a specific description, since its value is required in the sub clauses below. It is referred to as the *Principal frequency* of the signal.

The Principal frequency F_N is indicative for the maximum symbol rate [kbaud] that can be transported within these signal limits. A signal with a higher Principal Frequency occupies a wider spectrum. The subclause below are defined for all Principal frequencies between 32kHz and 1160 kHz.

Table 46 gives several examples on how to use the naming convention for specifying the actual parameter value F_n . It also illustrates some (informative) bit rates that can be transported within these signal limits, when using the associated (informative) modulation parameters. These are examples only, other system implementations may use the same signal limits in a different way.

Signal category	F_N [kHz]	Symbol Rate [kbaud]	Bit/symbol	Bit Rate [kb/s]
Proprietary.SymDSL.2B1Q::80	80 kHz	80	2	160
Proprietary.SymDSL.2B1Q::1160	1160 kHz	1160	2	2320

Table 46: Example on how the naming convention relates to the actual parameter value F_N that is used in the sub clauses below to specify the signal limits of this signal category. The actual bitrates and modulation parameters are implementation dependent, and informative only.

8.9.1. Total Signal Power

To be compliant with this signal category, the mean signal power into a resistive load of 135Ω shall not exceed a level of 14 dBm, measured within a frequency band from at least 100 Hz to $2 \times F_N$.

(no ETSI reference)

8.9.2. Peak amplitude

To be compliant with this signal category, the nominal voltage peak of the largest signal pulse into a resistive load of 135Ω shall not exceed a level of $V_{\text{peak}} = 3,7V(\pm 7\%)$, measured within a frequency band from at least 100 Hz to $F_N \times 2$

(no ETSI reference)

8.9.3. Narrow-band signal power (NBSP)

To be compliant with this signal category, the narrow-band signal power (NBSP) into a resistive load impedance R , shall not exceed the limits given in table 48, at any point in the frequency range 100 Hz to 30 MHz. Limits for intermediate frequencies can be found by drawing a straight line between the break points on a logarithmic (Hz) - linear (dB) scale. Table 41 describes the break points of these limits for all Principal frequencies between 32 and 1160 kHz. Figure 24 illustrates the NBSP in a bandwidth-normalised way.

The NBSP is the average power P of a sending signal into a load resistance R , within a power bandwidth B . The measurement method of the NBSP is described in sub-clause 12.1.

(no ETSI reference)

frequency f	Impedance R	Signal Level P [dBm]	Noise Bandwidth B	Spectral Power P/B [dBm/Hz]
0,1 kHz	135Ω	$P_0 + 1 + 20$	100 Hz	$P_0 + 1$
1 kHz	135Ω	$P_0 + 1 + 20$	100 Hz	$P_0 + 1$
1 kHz	135Ω	$P_0 + 1 + 30$	1 kHz	$P_0 + 1$
10 kHz	135Ω	$P_0 + 1 + 30$	1 kHz	$P_0 + 1$
10 kHz	135Ω	$P_0 + 1 + 40$	10 kHz	$P_0 + 1$
$0,2 \times F_N$	135Ω	$P_0 + 1 + 40$	10 kHz	$P_0 + 1$
$0,5 \times F_N$	135Ω	$P_0 - 2,5 + 40$	10 kHz	$P_0 - 2,5$
$0,75 \times F_N$	135Ω	$P_0 - 12 + 40$	10 kHz	$P_0 - 12$
$1 \times F_N$	135Ω	$P_0 - 34 + 40$	10 kHz	$P_0 - 34$
$1,5 \times F_N$	135Ω	$P_0 - 38 + 40$	10 kHz	$P_0 - 38$
$3,5 \times F_N$	135Ω	$P_0 - 75 + 40$	10 kHz	$P_0 - 75$
$6 \times F_N$	135Ω	-77	10 kHz	-117
$6 \times F_N$	135Ω	-57	1 MHz	-117
30 MHz	135Ω	-57	1 MHz	-117

Table 47: Break points of the narrow-band signal power P , as a function of the Principal frequency F_N of the signal category.

The reference power level, P_0 , in Table 47 is given by the formula below. Its value has been evaluated for a few sample Principal frequencies.

$$P_0 = 10 \log_{10} \left(\frac{2.7^2}{135} \times \frac{1 \text{ kHz}}{F_N} \right).$$

F_N	80	264	520	1160	kHz
P_0	-31,71	-36,89	-39,84	-43,32	dBm/Hz

Table 48: Reference power levels, as a function of the Principle frequency. The table summarizes some examples values, calculated from this formula.

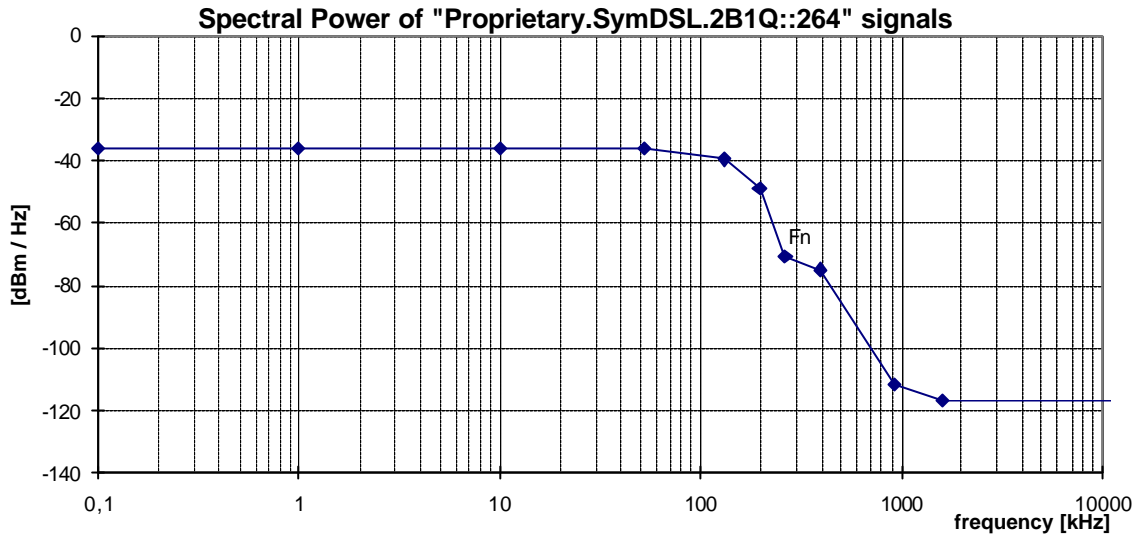

Figure 24: Spectral Power, for "Proprietary.SymDSL.2B1Q::264" signals (at $F_N=264$ kHz), as specified in Table 41. Note that these curves are dependent on the Principal frequency F_N , and that this figure shows an example only.

8.9.4. Unbalance about earth

To be compliant with this signal category, the balance of the signal that may flow through the LT-port or NT-port shall exceed minimum requirements, under the condition that the local loop wiring and its termination is well balanced. This can be verified by a longitudinal output voltage (LOV) and a longitudinal conversion loss (LCL) measurement at the source of that signal, as specified in sub-clause 12.2.2 and 12.2.3. The minimum LOV and LCL requirements hold for what can be observed at the ports of the Local Loop Wiring, when the Local Loop Wiring is replaced by an artificial impedance network described in sub-clause 12.2.2 and 12.2.3.

The differential termination impedance for LOV and LCL measurements shall be chosen equally to the design impedance $R_T=135 \Omega$ of the Signal Source under test.

The observed LOV shall have an rms voltage of below the value specified in table 49, measured in a power bandwidth B , centred over any frequency in the range from f_{min} to f_{max} , and averaged in any one second period. Compliance with this limitation is required with a longitudinal terminating impedance having value $Z_L(\omega)=R_L+1/(j\omega C_L)$ for all frequencies between f_{min} to f_{max} . Sub clause 12.2.2 defines an example measurement method for longitudinal output voltage.

The observed LCL shall be higher than the lower limits given in figure 25. The LCL values of the associated break frequencies of this figure are given in table 50. Sub clause 12.2.3 defines an example measurement method for longitudinal conversion loss.

(no ETSI reference)

LOV	B	f_{min}	f_{max}	R_L	C_L
-50dBV	4 kHz	100 kHz	400 kHz	100Ω	150 nF

Table 49: Values for the LOV limits.

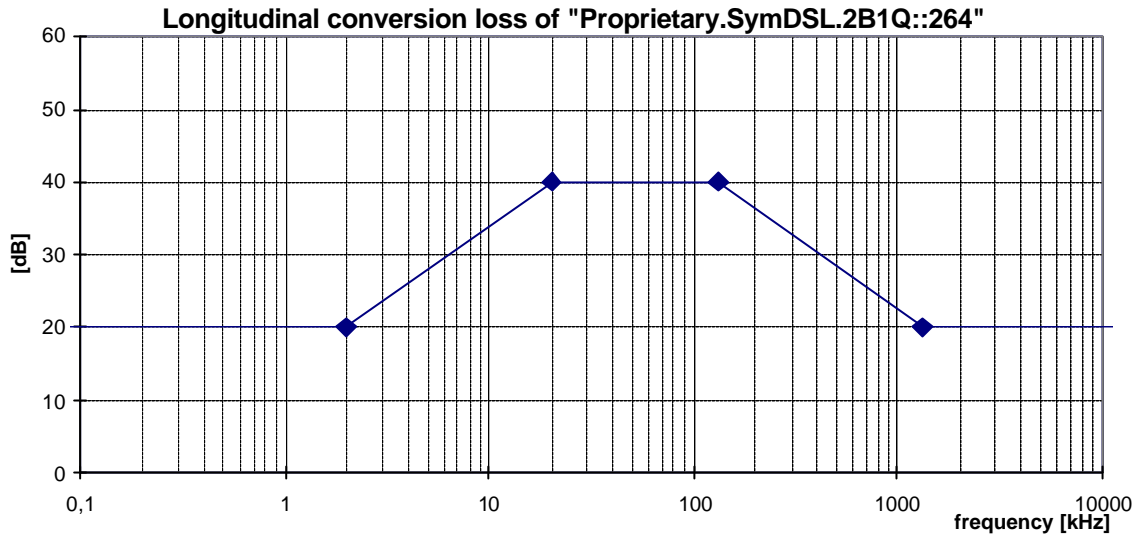

Figure 25: Minimum longitudinal conversion loss for a "Proprietary.SymDSL.2B1Q::264" signal source.

Frequency	LCL
<2 kHz	20 dB
2 kHz	20 dB
20 kHz	40 dB
1/2×F _N	40 dB
5×F _N	20 dB
30 MHz	20 dB

Table 50: Frequencies and LCL values of the breakpoints of the LCL mask in figure 25.

8.9.5. Feeding Power (from the LT-port)

To be compliant with this signal category, the DC feeding voltage and feeding current, used for the 2B1Q SDSL service shall not exceed the maximum values in table 51. The value for power includes a possible overload or short circuit condition at the user-network interface.

(no ETSI reference)

Voltage	Current	Power NT-Port
Maximum 99V	40 mA	Maximum 1100 mW

Table 51: Maximum feeding requirements for the leased line service over "Proprietary.SymDSL.2B1Q::Fn".

8.10. "Proprietary.PCM.HDB3.2M.SR" Signals

This category covers signals generated by 2Mbit/s transmission equipment on two wire-pairs, usable for instance for ISDN-Primary Rate Access. This category include HDB3 line coding and sine shaped transmit pulses in case of sending a randomized bit sequence. This signal is labelled as *proprietary*, since it is not covered by ETSI, ITU nor ANSI product standards.

A signal can be classified as an " Proprietary.PCM.HDB3.2M.SR" signal if it is compliant with all subclauses below.

NOTE The signals covered here are only applicable to systems wich are using sine shaped transmit pulses and in case of sending a randomized bit sequence.

Special bit sequences like AIS (Alarm Indication Signal) or others and other transmit pulse forms than described here can cause different signals. The way these characteristics are to be covered by specifications, are for further study.

8.10.1. Total signal power

To be compliant with this signal category, the mean signal power into a resistive load of $130\ \Omega$ shall not exceed a level of 11 dBm ($\pm 0,5$ dBm), measured within a frequency band from at least 100 Hz to 20 MHz.

8.10.2. Peak amplitude

To be compliant with this signal category, the nominal voltage peak of the largest signal pulse into a resistive load of $130\ \Omega$ shall not exceed a level of 2,36 V ($\pm 10\%$), measured within a frequency band from at least 100 Hz to 20 MHz.

8.10.3. Narrow-band signal power

To be compliant with this signal category, the narrow-band signal power (NBSP) into a resistive load impedance R , shall not exceed the limits given in table 52, at any point in the frequency range 100 Hz to 30 MHz. This table specifies the break points of these limits. Limits for intermediate frequencies can be found by drawing a straight line between the break points on a logarithmic (Hz) - linear (dB) scale. Figure 26 illustrates the NBSP in a bandwidth-normalised way.

The NBSP is the average power P of a sending signal into a load resistance R , within a power bandwidth B . The measurement method of the NBSP is described in sub-clause 12.1.

Centre frequency f	Impedance R	Signal Level P	Power bandwidth B	Spectral Power P/B
0,51 kHz	$130\ \Omega$	-49,8 dBm	100 Hz	-69,8 dBm/Hz
10 kHz	$130\ \Omega$	-42 dBm	100 Hz	-62 dBm/Hz
10 kHz	$130\ \Omega$	-22 dBm	10 kHz	-62 dBm/Hz
1 MHz	$130\ \Omega$	-10 dBm	10 kHz	-50 dBm/Hz
20 MHz	$130\ \Omega$	-59 dBm	10 kHz	-99 dBm/Hz
>20 MHz	$130\ \Omega$	-80 dBm	10 kHz	-120 dBm/Hz
20 MHz	$130\ \Omega$	-60 dBm	1 MHz	-120 dBm/Hz
30 MHz	$130\ \Omega$	-60 dBm	1 MHz	-120 dBm/Hz

Table 52: Break points of the narrow-band power limits.

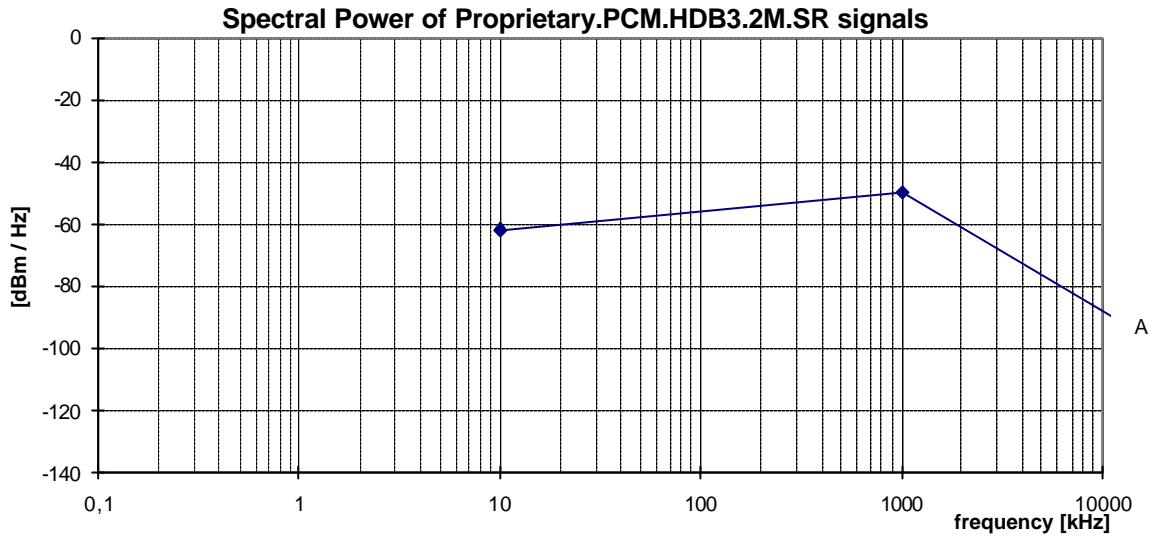

Figure 26: Spectral Power, for Proprietary.PCM.HDB3.2M.SR signals, as specified in table 52.

8.10.4. Unbalance about earth

To be compliant with this signal category, the balance of the signal that may flow through the LT-port or NT-port shall exceed minimum requirements, under the condition that the local loop wiring and its termination is well balanced. This can be verified by a longitudinal output voltage (LOV) and a longitudinal conversion loss (LCL) measurement at the source of that signal, as specified in sub-clause 12.2.2 and 12.2.3. The minimum LOV and LCL requirements hold for what can be observed at the ports of the Local Loop Wiring, when the Local Loop Wiring is replaced by an artificial impedance network described in sub-clause 12.2.2 and 12.2.3.

The differential termination impedance for LOV and LCL measurements shall be chosen equally to the design impedance $R_T=135 \Omega$ of the Signal Source under test.

The observed LOV shall have an rms voltage of below the value specified in table 53, measured in a power bandwidth B , centred over any frequency in the range from f_{min} to f_{max} , and averaged in any one second period. Compliance with this limitation is required with a longitudinal terminating impedance having value $Z_L(\omega)=R_L+1/(j\omega C_L)$ for all frequencies between f_{min} to f_{max} . Sub clause 12.2.2 defines an example measurement method for longitudinal output voltage.

The observed LCL shall be higher than the lower limits given in figure 54. The LCL values of the associated break frequencies of this figure are given in table 54. Sub clause 12.2.3 defines an example measurement method for longitudinal conversion loss.

(no ETSI reference)

LOV	B	f_{min}	f_{max}	R_L	C_L
-46dBV	10 kHz	5,1 kHz	2,15 MHz	100Ω	150 nF

Table 53: Values for the LOV limits.

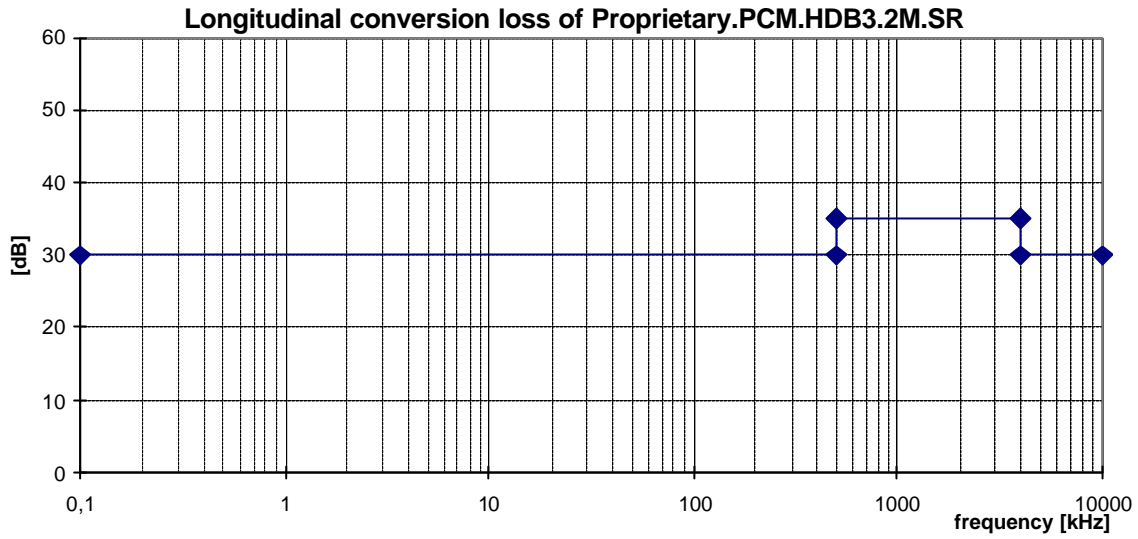

Figure 27: Minimum longitudinal conversion loss for a "Proprietary.PCM.HDB3.2M.SR" signal source

Frequency range	LCL
<500 kHz	30 dB
500 kHz	35 dB
1000 kHz	35 dB
4000 kHz	35 dB
30 MHz	30 dB

Table 54: Frequencies and LCL values of the breakpoints of the LCL mask in figure 27.

8.10.5. Feeding Power (from the LT-port)

To be compliant with this signal category, the DC feeding voltage and feeding current, used for the optional use of Regenerators shall not exceed the maximum values in table 11. The value for power includes a possible overload or short circuit condition at the user-network interface.

Voltage	Current
Maximum 120 V between both DC-shortened Wire pairs	59 mA

Table 55 Maximum feeding requirements

9. Cluster 4 Signals (asymmetrical broad band)

This cluster summarises asymmetrical signals that are generated by digital transmission equipment up to 8 Mb/s, including ADSL. Asymmetrically means a bit rate in the downstream direction and a significantly lower bitrate (e.g. 25%) in the upstream direction.

NOTE Asymmetrical DSL systems generate different signals in different transmission directions. Reversal of their transmission direction, which means the injection of upstream signals into LT-ports and downstream signals into the NT-ports, will cause a substantial reduction of the maximum reach. Such a reduction is even significant for all asymmetrical DSL systems when only one such system is reversed. Therefore the classification of asymmetrical DSL systems is consequently split into upstream and downstream specifications.

9.1. "ADSL over POTS" Signals

This category covers signals, generated by ADSL transmission equipment. These signals may share the same wire pair with POTS signals.

This clause is based on ETSI, ANSI and ITU reports on ADSL equipment [13,14,16]. A signal can be classified as an "ADSL over POTS" signal if it is compliant with all subclauses below.

9.1.1. Total signal power (downstream only)

To be compliant with this signal category, the mean downstream signal power into a resistive load of 100 Ω shall not exceed a level of 20,4 dBm, measured within a frequency band from at least 4 kHz to 3 MHz.

If measurements of the upstream power indicates that downstream power back-off is necessary, as described for the downstream PSD, than the maximum total transmit power shall be reduced accordingly.

Reference [15]: [ANSI-T1.413, issue 2: clause 6.15.1 and 6.15.3]

Reference [16]: [ITU-G992.1: clause A.1.2.3.1]

9.1.2. Total signal power (upstream only)

To be compliant with this signal category, the mean upstream signal power into a resistive load of 100 Ω shall not exceed a level of 12,5 dBm, measured within a frequency band from at least 4 kHz to 3 MHz.

Reference [15]: [ANSI-T1.413, issue 2: clause 7.15.1 and 7.15.3]

Reference [16]: [ITU-G992.1: clause A.2.4.3.1]

9.1.3. Peak amplitude (upstream and downstream)

To be compliant with this signal category, the nominal voltage peak of the largest signal pulse into a resistive load of 100 Ω shall not exceed a level of 7,5V (14V peak-peak), measured within a frequency band from at least 100 Hz to 1 MHz.

(no ETSI reference)

9.1.4. Narrow-band signal power (downstream only)

To be compliant with this signal category, the narrow-band signal power (NBSP) into a resistive load impedance R , shall not exceed the limits given in table 56, at any point in the frequency range 100 Hz to 30 MHz. This table specifies the break points of these limits. Limits for intermediate frequencies can be found by drawing a straight line between the break points on a logarithmic (Hz) - linear (dB) scale. Figure 28 illustrates the NBSP in a bandwidth-normalised way.

The NBSP is the average power P of a sending signal into a load resistance R , within a power bandwidth B . The measurement method of the NBSP is described in sub-clause 12.1.

NOTE The NBSP specification in table 56 is reconstructed from the commonly used PSD specifications in [13,14,16] (similar to figure 28), and used here since it is much wider applicable. This enables a unified specification method. PSD specifications are adequate when signals are purely random in nature, but cannot cover harmonic components in a signal (would cause infinite high "PSD" levels at these harmonic frequencies). NBSP specifications cover both signal types.

The NBSP specification of this signal category has been split into two overlapping limits. Both upper limits shall hold simultaneously. The 10 kHz bandwidth values represent the "maximum PSD values" from [13,14,16], and includes the pass band ripple. The 100 kHz bandwidth values represent the "average PSD values" in the passband to smooth out the spectral ripple of 3.5 dB. The 1 MHz bandwidth specification is equivalent to the "sliding window" specification in [13,14,16].

Reference [15]: [ANSI-T1.413, issue 2: clause 6.14] reconstructed from PSD requirements

Reference [16]: [ITU-G992.1: clause A.1.2] reconstructed from PSD requirements

Centre frequency f	Impedance R	Signal Level P	Power bandwidth B	Spectral Power P/B	
0,1 kHz	600Ω	-77,5 dBm	100 Hz	-97,5 dBm/Hz	A
1 kHz	600Ω	-77,5 dBm	100 Hz	-97,5 dBm/Hz	
1 kHz	600Ω	-67,5 dBm	1 kHz	-97,5 dBm/Hz	
4 kHz	600Ω	-67,5 dBm	1 kHz	-97,5 dBm/Hz	
4 kHz	100Ω	-52,5 dBm	10 kHz	-92,5 dBm/Hz	
25,875 kHz	100Ω	+3,5 dBm	10 kHz	-36,5 dBm/Hz	
1104 kHz	100Ω	+3,5 dBm	10 kHz	-36,5 dBm/Hz	
3093 kHz	100Ω	-50 dBm	10 kHz	-90 dBm/Hz	
11040 kHz	100Ω	-50 dBm	10 kHz	-90 dBm/Hz	B
30000 kHz	100Ω	-50 dBm	10 kHz	-90 dBm/Hz	
60 kHz	100Ω	$P_{BO} + 50$ dBm	100 kHz	P_{BO} dBm/Hz	
1104 kHz	100Ω	$P_{BO} + 50$ dBm	100 kHz	P_{BO} dBm/Hz	
3093 kHz	100Ω	-40 dBm	100 kHz	-90 dBm/Hz	
3093 kHz	100Ω	-30 dBm	1 MHz	-90 dBm/Hz	
4545 kHz	100Ω	-50 dBm	1 MHz	-110 dBm/Hz	
30000 kHz	100Ω	-50 dBm	1 MHz	-110 dBm/Hz	

Table 56: Break points of the narrow-band power limits. The values for parameter P_{BO} are defined in table 57, and are dependent from the received upstream power (Power back-off).

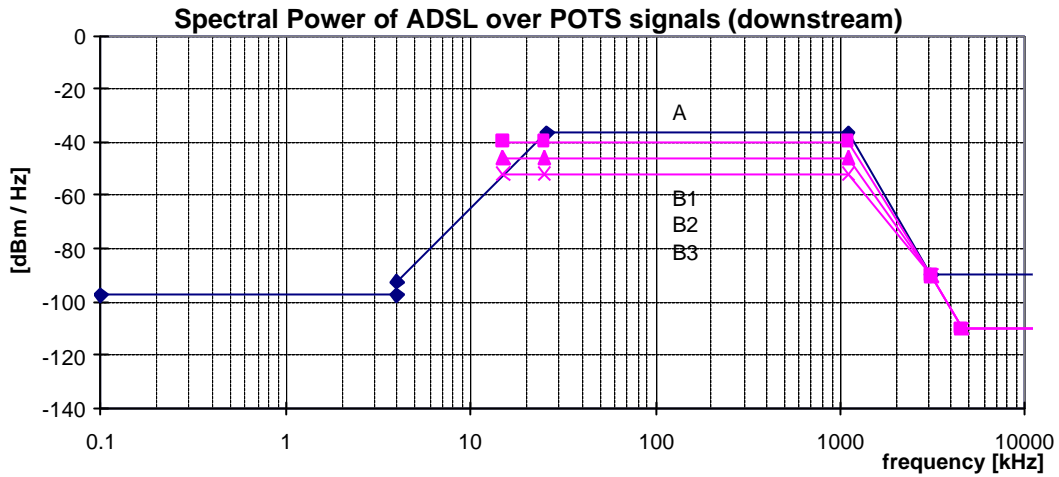

Figure 28: Spectral Power, for ADSL over POTS signals, as specified in table 56. The maximum spectral power varies with the value of parameter P_{BO} , as defined in table 57. Only the curves for the values $P_{BO}=-40$ dBm/Hz, $P_{BO}=-46$ dBm/Hz, and $P_{BO}=-52$ dBm/Hz are shown here.

Power back-off. To be compliant with this signal category, the maximum downstream signal power shall be reduced when the received upstream power is above specified levels. If the total received upstream power from 28,031 to 79,781 kHz (ADSL sub-carriers 7-18) is greater than 3 dBm into 100 ohm then parameter P_{BO} shall not exceed the values shown in table 57. The received upstream power measurement shall be performed with an accuracy of ± 1 dB or better. Reference [15]: [ANSI-T1.413, issue 2: clause 9.4.6] Reference [16]: [ITU-G992.1: clause A.3.1]

Upstream received power [dBm]	<3	<4	<5	<6	<7	<8	<9
Parameter P_{BO} [dBm/Hz]	-40	-42	-44	-46	-48	-50	-52

Table 57: Definition of parameter P_{BO} , as used in table 56 (Power Back-off, or Power Cut-Back).

9.1.5. Narrow-band signal power (upstream only)

To be compliant with this signal category, the narrow-band signal power (NBSP) into a resistive load impedance R , shall not exceed the limits given in table 58, at any point in the frequency range 100 Hz to 30 MHz. This table specifies the break points of these limits. Limits for intermediate frequencies can be found by drawing a straight line between the break points on a logarithmic (Hz) - linear (dB) scale. Figure 29 illustrates the NBSP in a bandwidth-normalised way.

The NBSP is the average power P of a sending signal into a load resistance R , within a power bandwidth B . The measurement method of the NBSP is described in sub-clause 12.1.

NOTE The NBSP specification in table 56 is reconstructed from the commonly used PSD specifications in [13,14,16] (similar to figure 29), and used here since it is much wider applicable. This enables a unified specification method. PSD specifications are adequate when signals are purely random in nature, but cannot cover harmonic components in a signal (would cause infinite high "PSD" levels at these harmonic frequencies). NBSP specifications cover both signal types. The NBSP specification of this signal category has been split into two overlapping limits. Both upper limits shall hold simultaneously. The 10 kHz bandwidth values represent the "maximum PSD values" from [13,14,16], and includes the pass band ripple. The 100 kHz bandwidth values represent the "average PSD values" in the passband to smooth out the spectral ripple of 3,5 dB. The 1 MHz bandwidth specification is equivalent to the "sliding window" specification in [13,14,16].

Reference [15]: [ANSI-T1.413, issue 2: clause 7.14] reconstructed from PSD requirements

Reference [16]: [ITU-G992.1: clause A.2.4] reconstructed from PSD requirements

Centre frequency f	Impedance R	Signal Level P	Power bandwidth B	Spectral Power P/B	
0,1 kHz	600Ω	-77,5 dBm	100 Hz	-97,5 dBm/Hz	A
1 kHz	600Ω	-77,5 dBm	100 Hz	-97,5 dBm/Hz	
1 kHz	600Ω	-67,5 dBm	1 kHz	-97,5 dBm/Hz	
4 kHz	600Ω	-67,5 dBm	1 kHz	-97,5 dBm/Hz	
4 kHz	100Ω	-52,5 dBm	10 kHz	-92,5 dBm/Hz	
25,875 kHz	100Ω	+5,5 dBm	10 kHz	-34,5 dBm/Hz	
138 kHz	100Ω	+5,5 dBm	10 kHz	-34,5 dBm/Hz	
307 kHz	100Ω	-50 dBm	10 kHz	-90 dBm/Hz	
11040 kHz	100Ω	-50 dBm	10 kHz	-90 dBm/Hz	B
30000 kHz	100Ω	-50 dBm	10 kHz	-90 dBm/Hz	
60 kHz	100Ω	+12 dBm	100 kHz	-38 dBm/Hz	
138 kHz	100Ω	+12 dBm	100 kHz	-38 dBm/Hz	
307 kHz	100Ω	-40 dBm	100 kHz	-90 dBm/Hz	
1221 kHz	100Ω	-40 dBm	100 kHz	-90 dBm/Hz	
1221 kHz	100Ω	-30 dBm	1 MHz	-90 dBm/Hz	
1630 kHz	100Ω	-50 dBm	1 MHz	-110 dBm/Hz	
11040 kHz	100Ω	-50 dBm	1 MHz	-110 dBm/Hz	
30000 kHz	100Ω	-50 dBm	1 MHz	-110 dBm/Hz	

Table 58: Break points of the narrow-band power limits.

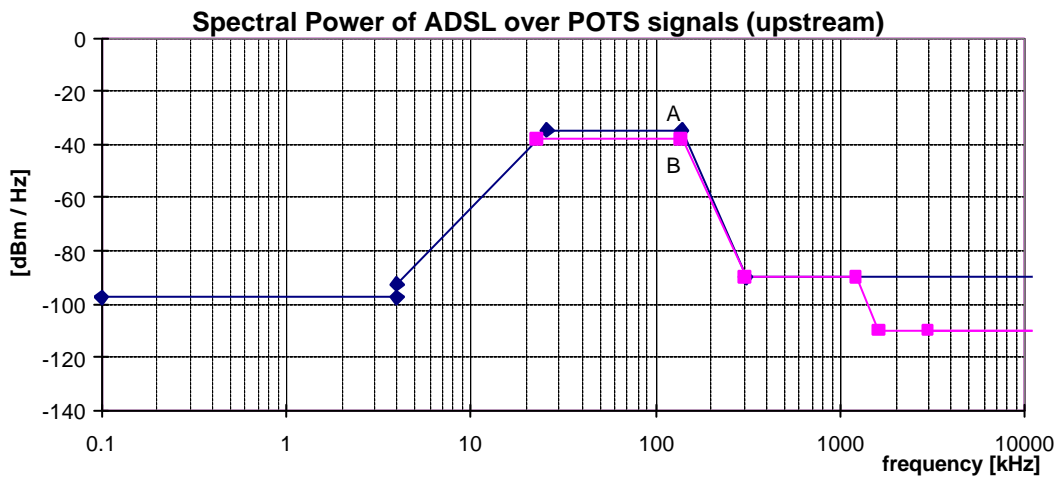

Figure 29: Spectral Power, for ADSL over POTS signals, as specified in table 58.

9.1.6. Unbalance about earth (upstream and downstream)

To be compliant with this signal category, the balance of the signal that may flow through the LT-port or NT-port shall exceed minimum requirements, under the condition that the local loop wiring and its termination is well balanced. This can be verified by a longitudinal output voltage (LOV) and a longitudinal conversion loss (LCL) measurement at the source of that signal, as specified in sub-clause 12.2.2 and 12.2.3. The minimum LOV and LCL requirements hold for what

can be observed at the ports of the Local Loop Wiring, when the Local Loop Wiring is replaced by an artificial impedance network described in sub-clause 12.2.2 and 12.2.3.

The differential termination impedance for LOV and LCL measurements shall be chosen equally to the design impedance $R_T=100\ \Omega$ of the Signal Source under test.

The observed LOV shall have an rms voltage of below the value specified in table 59, measured in a power bandwidth B , centred over any frequency in the range from f_{min} to f_{max} , and averaged in any one second period. Compliance with this limitation is required with a longitudinal terminating impedance having value $Z_L(\omega)=R_L+1/(j\omega C_L)$ for all frequencies between f_{min} to f_{max} . Sub clause 12.2.2 defines an example measurement method for longitudinal output voltage.

The observed LCL shall be higher than the lower limits given in figure 30. The LCL values of the associated break frequencies of this figure are given in table 60. Sub clause 12.2.3 defines an example measurement method for longitudinal conversion loss. To be compliant with this signal category, this requirement shall be met for both the switched-on and switched-off mode of the signal source.

Reference [15]: [ANSI-T1.413 issue 2: clause 12.3.1] extended to 30 MHz according to Reference [20]:

Reference [20]: [ETSI-TS 101 270-1: clause 8.3.3] and E.3.2.

	LOV	B	f_{min}	f_{max}	R_L	C_L
downstream	-46dBV	10 kHz	5,1 kHz	1825 kHz	100 Ω	150 nF
upstream	-46dBV	10 kHz	5,1 kHz	210 kHz	100 Ω	150 nF

Table 59: Values for the LOV limits.

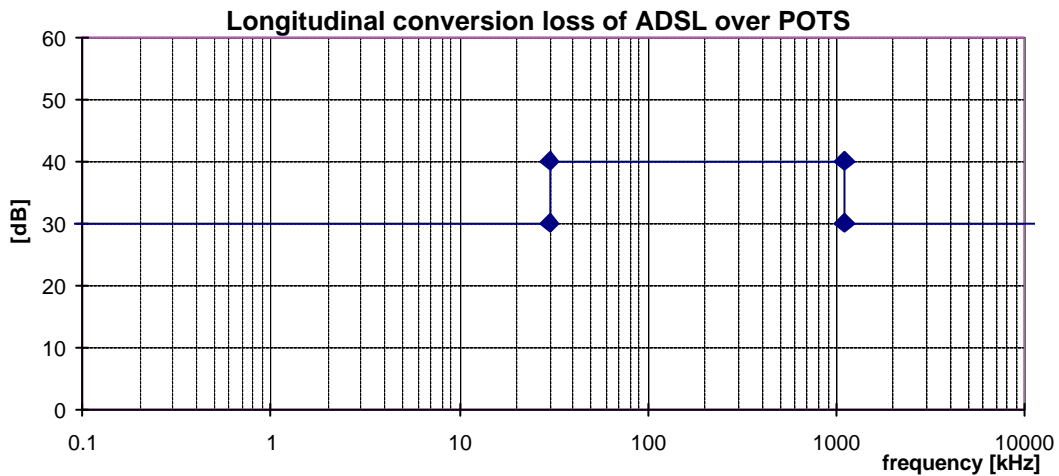

Figure 30: Minimum longitudinal conversion loss.

Frequency	LCL
< 30 kHz	30 dB
30 kHz	40 dB
1104 kHz	40 dB
>1104 kHz	30 dB

Table 60: Frequencies and LCL values of the breakpoints of the LCL mask in figure 30.

9.2. "ADSL over ISDN" Signals

This category covers signals, generated by ADSL transmission equipment. These signals may share the same wire pair with ISDN signals.

This clause is based on ETSI and ITU reports on ADSL equipment [13,16]. A signal can be classified as an "ADSL over ISDN" signal if it is compliant with all subclauses below.

9.2.1. Total signal power (downstream only)

To be compliant with this signal category, the mean downstream signal power into a resistive load of 100 Ω shall not exceed a level of 19,83 dBm, measured within a frequency band from at least 4 kHz to 3 MHz.

If measurements of the upstream power indicates that downstream power back-off is necessary, as described for the downstream PSD, than the maximum total transmit power shall be reduced accordingly.

Reference [13]: [ETSI TS 101 388: clause 5.2]

9.2.2. Total signal power (upstream only)

To be compliant with this signal category, the mean upstream signal power into a resistive load of 100 Ω shall not exceed a level of 13,26 dBm, measured within a frequency band from at least 4 kHz to 3 MHz.

Reference [13]: [ETSI TS 101 388: clause 6.3]

9.2.3. Peak amplitude (upstream and downstream)

To be compliant with this signal category, the nominal voltage peak of the largest signal pulse into a resistive load of 100 Ω shall not exceed a level of 7,5V (14V peak-peak), measured within a frequency band from at least 100 Hz to 1 MHz.

(no ETSI reference)

9.2.4. Narrow-band signal power (downstream only)

To be compliant with this signal category, the narrow-band signal power (NBSP) into a resistive load impedance R , shall not exceed the limits given in table 61, at any point in the frequency range 100 Hz to 30 MHz. This table specifies the break points of these limits. Limits for intermediate frequencies can be found by drawing a straight line between the break points on a logarithmic (Hz) - linear (dB) scale. Figure 31 illustrates the NBSP in a bandwidth-normalised way.

The NBSP is the average power P of a sending signal into a load resistance R , within a power bandwidth B . The measurement method of the NBSP is described in sub-clause 12.1.

Reference [13]: [ETSI TS 101 388: clause 5.4] reconstructed from PSD requirements

Reference [16]: [ITU-G992.1: clause B.1.3] reconstructed from PSD requirements

NOTE The NBSP specification in table 61 is reconstructed from the commonly used PSD specifications in [13, 16] (similar to figure 31), and used here since it is much wider applicable. This enables a unified specification method. PSD specifications are adequate when signals are purely random in nature, but cannot cover harmonic components in a signal (would cause infinite high "PSD" levels at these harmonic frequencies). NBSP specifications cover both signal types.

The NBSP specification of this signal category has been split into two overlapping limits. Both upper limits shall hold simultaneously. The 10 kHz bandwidth values represent the "maximum PSD values" from [13, 16], and includes the pass band ripple. The 100 kHz bandwidth values represent the "average PSD values" in the passband to smooth out the spectral ripple of 3,5 dB. The 1 MHz bandwidth specification is equivalent to the "sliding window" specification in [13, 16].

Centre Frequency f	Impedance R	Signal Level P	Power bandwidth B	Spectral Power P/B	
0,1 kHz	100Ω	-70 dBm	100 Hz	-90 dBm/Hz	A
1 kHz	100Ω	-70 dBm	100 Hz	-90 dBm/Hz	
1 kHz	100Ω	-60 dBm	1 kHz	-90 dBm/Hz	
4 kHz	100Ω	-60 dBm	1 kHz	-90 dBm/Hz	
4 kHz	100Ω	-50 dBm	10 kHz	-90 dBm/Hz	
50 kHz	100Ω	-50 dBm	10 kHz	-90 dBm/Hz	
80 kHz	100Ω	-41,8 dBm	10 kHz	-81,8 dBm/Hz	
120 kHz	100Ω	+3,5 dBm	10 kHz	-36,5 dBm/Hz	
1104 kHz	100Ω	+3,5 dBm	10 kHz	-36,5 dBm/Hz	
3093 kHz	100Ω	-50 dBm	10 kHz	-90 dBm/Hz	
11040 kHz	100Ω	-50 dBm	10 kHz	-90 dBm/Hz	
30000 kHz	100Ω	-50 dBm	10 kHz	-90 dBm/Hz	
100 kHz	100Ω	$P_{BO} + 50$ dBm	100 kHz	P_{BO} dBm/Hz	B
1104 kHz	100Ω	$P_{BO} + 50$ dBm	100 kHz	P_{BO} dBm/Hz	
3093 kHz	100Ω	-40 dBm	100 kHz	-90 dBm/Hz	
3093 kHz	100Ω	-30 dBm	1 MHz	-90 dBm/Hz	
4545 kHz	100Ω	-50 dBm	1 MHz	-110 dBm/Hz	
30000 kHz	100Ω	-50 dBm	1 MHz	-110 dBm/Hz	

Table 61: Break points of the narrow-band power limits. The values for parameter P_{BO} are defined in table 62, and are dependent from the received upstream power (Power back-off).

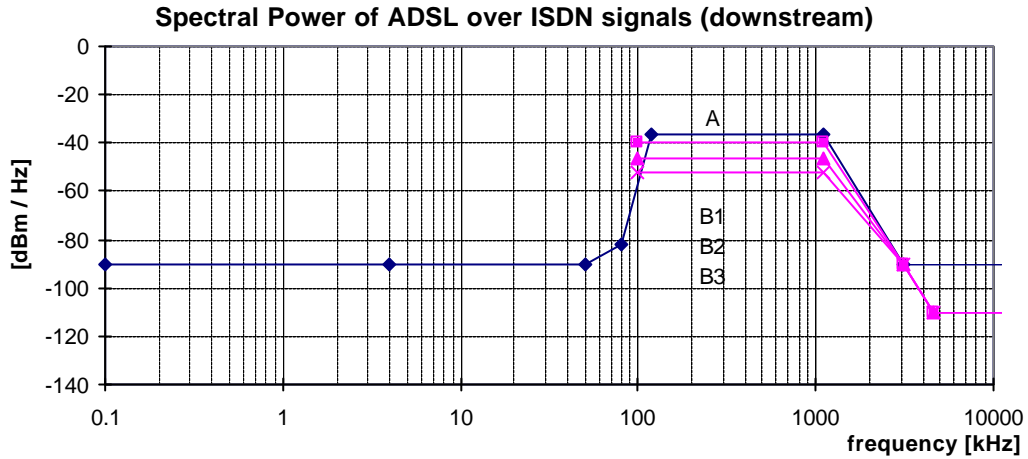

Figure 31: Spectral Power, for ADSL over ISDN signals, as specified in table 61. The maximum spectral power varies with the value of parameter P_{BO} , as defined in table 62. Only the curves for the values $P_{BO}=-40$ dBm/Hz, $P_{BO}=-46$ dBm/Hz, and $P_{BO}=-52$ dBm/Hz are shown here.

Power back-off. To be compliant with this signal category, the maximum downstream signal power shall be reduced when the received upstream power is above specified levels. If the total received upstream power from 170,34 to 222,09 kHz (ADSL sub-carriers 40-51) is greater than 0 dBm into 100 ohm then parameter P_{BO} shall not exceed the values shown in table 62. The received upstream power measurement shall be performed with an accuracy of ± 1 dB or better.

Reference [13]: [ETSI TS 101 388: clause 7.17] (Uses subcarrier 40-51, values that have been adopted here)

Reference [16]: [ITU-G992.1: clause B.3.3] (Uses subcarrier 36-51, values that have been ignored here)

Upstream received power (dBm)	<0	<1,5	<3	<4,5	<6	<7,5	<9
Parameter P_{BO}	-40	-42	-44	-46	-48	-50	-52

Table 62: Definition of parameter P_{BO} , as used in table 61 (Power Back-off, or Power Cut-Back).

9.2.5. Narrow-band signal power (upstream only)

To be compliant with this signal category, the narrow-band signal power (NBSP) into a resistive load impedance R , shall not exceed the limits given in table 63, at any point in the frequency range 100 Hz to 30 MHz. This table specifies the break points of these limits. Limits for intermediate frequencies can be found by drawing a straight line between the break points on a logarithmic (Hz) - linear (dB) scale. Figure 32 illustrates the NBSP in a bandwidth-normalised way.

The NBSP is the average power P of a sending signal into a load resistance R , within a power bandwidth B . The measurement method of the NBSP is described in sub-clause 12.1.

NOTE The NBSP specification in table 63 is reconstructed from the commonly used PSD specifications in [13, 16] (similar to figure 32), and used here since it is much wider applicable. This enables a unified specification method. PSD specifications are adequate when signals are purely random in nature, but cannot cover harmonic components in a signal (would cause infinite high "PSD" levels at these harmonic frequencies). NBSP specifications cover both signal types.

The NBSP specification of this signal category has been split into two overlapping limits. Both upper limits shall hold simultaneously. The 10 kHz bandwidth values represent the "maximum PSD values" from [13, 16], and includes the pass band ripple. The 100 kHz bandwidth values represent the "average PSD values" in the passband to smooth out the spectral ripple of 3,5 dB. The 1 MHz bandwidth specification is equivalent to the "sliding window" specification in [13, 16].

Reference [13]: [ETSI TS 101 388: clause 6.10] reconstructed from PSD requirements

Reference [16]: [ITU-G992.1: clause B.2.2] reconstructed from PSD requirements

Centre frequency f	Impedance R	Signal Level P	Power bandwidth B	Spectral Power P/B	
0,1 kHz	100Ω	-70 dBm	100 Hz	-90 dBm/Hz	A
1 kHz	100Ω	-70 dBm	100 Hz	-90 dBm/Hz	
1 kHz	100Ω	-60 dBm	1 kHz	-90 dBm/Hz	
4 kHz	100Ω	-60 dBm	1 kHz	-90 dBm/Hz	
4 kHz	100Ω	-50 dBm	10 kHz	-90 dBm/Hz	
50 kHz	100Ω	-50 dBm	10 kHz	-90 dBm/Hz	
80 kHz	100Ω	-41,8 dBm	10 kHz	-81,8 dBm/Hz	
120 kHz	100Ω	+5,5 dBm	10 kHz	-34,5 dBm/Hz	
276 kHz	100Ω	+5,5 dBm	10 kHz	-34,5 dBm/Hz	
614 kHz	100Ω	-50 dBm	10 kHz	-90 dBm/Hz	
11040 kHz	100Ω	-50 dBm	10 kHz	-90 dBm/Hz	
30000 kHz	100Ω	-50 dBm	10 kHz	-90 dBm/Hz	
120 kHz	100Ω	+12 dBm	100 kHz	-38 dBm/Hz	B
276 kHz	100Ω	+12 dBm	100 kHz	-38 dBm/Hz	
614 kHz	100Ω	-40 dBm	100 kHz	-90 dBm/Hz	
1221 kHz	100Ω	-40 dBm	100 kHz	-90 dBm/Hz	
1221 kHz	100Ω	-30 dBm	1 MHz	-90 dBm/Hz	
1630 kHz	100Ω	-50 dBm	1 MHz	-110 dBm/Hz	
11040 kHz	100Ω	-50 dBm	1 MHz	-110 dBm/Hz	
30000 kHz	100Ω	-50 dBm	1 MHz	-110 dBm/Hz	

Table 63: Break points of the narrow-band power limits.

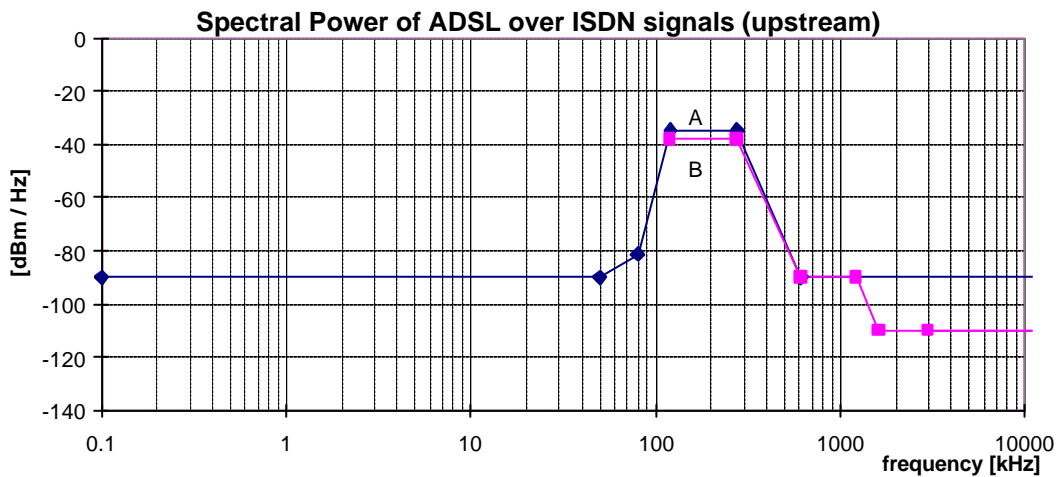

Figure 32: Spectral Power, for ADSL over ISDN signals, as specified in table 63.

9.2.6. Unbalance about earth (upstream and downstream)

To be compliant with this signal category, the balance of the signal that may flow through the LT-port or NT-port shall exceed minimum requirements, under the condition that the local loop wiring and its termination is well balanced. This can be verified by a longitudinal output voltage (LOV) and a longitudinal conversion loss (LCL) measurement at the

source of that signal, as specified in sub-clause 12.2.2 and 12.2.3. The minimum LOV and LCL requirements hold for what can be observed at the ports of the Local Loop Wiring, when the Local Loop Wiring is replaced by an artificial impedance network described in sub-clause 12.2.2 and 12.2.3.

The differential termination impedance for LOV and LCL measurements shall be chosen equally to the design impedance $R_T=100\ \Omega$ of the Signal Source under test.

The observed LOV shall have an rms voltage of below the value specified in table 64, measured in a power bandwidth B , centred over any frequency in the range from f_{min} to f_{max} , and averaged in any one second period. Compliance with this limitation is required with a longitudinal terminating impedance having value $Z_L(\omega)=R_L+1/(j\omega C_L)$ for all frequencies between f_{min} to f_{max} . Sub clause 12.2.2 defines an example measurement method for longitudinal output voltage.

The observed LCL shall be higher than the lower limits given in figure 33. The LCL values of the associated break frequencies of this figure are given in table 65. Sub clause 12.2.3 defines an example measurement method for longitudinal conversion loss. To be compliant with this signal category, this requirement shall be met for both the switched-on and switched-off mode of the signal source.

Reference [15]: [ANSI-T1.413, issue 2: clause 12.3.1] extended to 30 MHz according to Reference [20]

Reference [20]: [ETSI-TS 101 270-1: clause 8.3.3 and E.3.2]

	LOV	B	f_{min}	f_{max}	R_L	C_L
downstream	-46dBV	10 kHz	5,1 kHz	1825 kHz	100 Ω	150 nF
upstream	-46dBV	10 kHz	5,1 kHz	415 kHz	100 Ω	150 nF

Table 64: Values for the LOV limits.

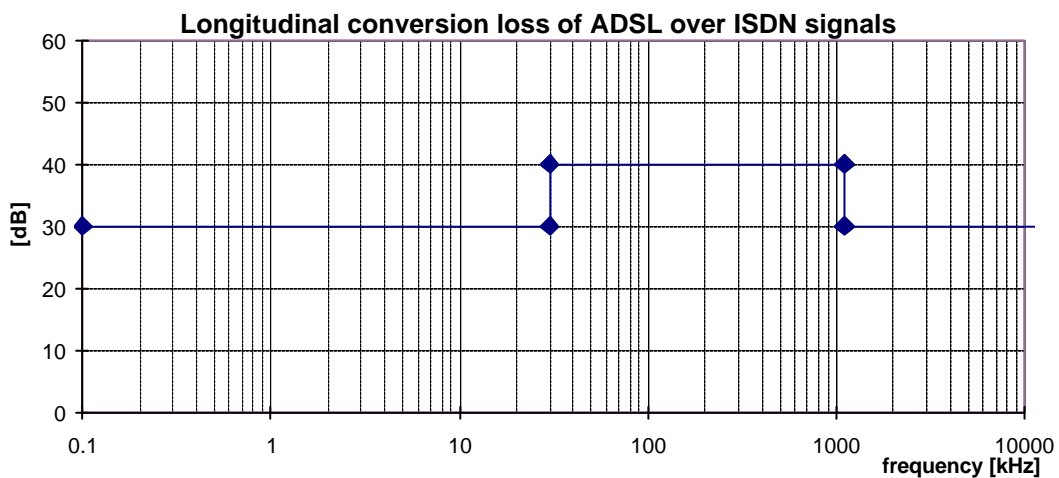

Figure 33: Minimum longitudinal conversion loss.

Frequency	LCL
< 30 kHz	30 dB
30 kHz	40 dB
1104 kHz	40 dB
>1104 kHz	30 dB

Table 65: Frequencies and LCL values of the breakpoints of the LCL-mask in figure 33.

9.3. "ADSL.FDD over POTS" Signals

This category covers signals, generated by ADSL transmission equipment, that work in a Frequency Division Duplexing mode to minimise crosstalk between upstream and downstream signals. This category is a subset of the (full) "ADSL over POTS" signal category.

This FDD mode for ADSL is currently under study, within the ETSI-TM6 ADSL project. When that study has been completed, the description of the agreed signal will be included here

9.4. "ADSL.FDD over ISDN" Signals

This category covers signals, generated by ADSL transmission equipment, that work in a Frequency Division Duplexing mode to minimise crosstalk between upstream and downstream signals. This category is a subset of the (full) "ADSL over ISDN" signal category.

This FDD mode for ADSL is currently under study, within the ETSI-TM6 ADSL project. When that study has been completed, the description of the agreed signal will be included here

10. Cluster 5 Signals (broad band up to 30 MHz)

10.1. "VDSL" Signals

The signals that will be generated by VDSL equipment are currently under study, within the ETSI-TM6 VDSL project. When that study has been completed, the description of the agreed signal will be included here

11. Measurement methods of signal parameters

11.1. Narrow-band signal power (voltage)

The narrow band signal power is defined as the average power **P** of a sending signal into a resistive load **R**, within a power bandwidth **B** centred at a specified frequency. The power bandwidth is different from commonly used –3dB bandwidth, since it fully accounts for the shape of the transfer function $H(f)$ of frequency selective filters while measuring narrow band power (or rms-voltage). The power bandwidth of a frequency selective filter is defined as shown below.

$$B_{\text{power}} = \frac{1}{|H_{\text{max}}|^2} \cdot \int |H(f)|^2 \cdot df$$

11.2. Unbalance about earth

Poor balance of a signal source, connected to a local loop wiring, leads to conditions in the network where systems using the same cable could be harmed. If the combination of system and wire pair shows a poor balance about earth, this will result in unwanted radiated emissions (egress) which will be visible in the environment of the wire pair and which also will be received by adjacent wire pairs (crosstalk).

11.2.1. Definition of earth

Measurements of both LOV and LCL must be considered as 3 terminal measurements. These terminals are the conductors of a port to the Local Loop Wiring or to a signal source (ESS, CSS or RSS). Two terminals are those of the differential mode and the third terminal is that of the earth used of the common mode.

- In the case of a signal source that is connected to a local earth point, then the measurement equipment should be connected to the same earth point. The earth point of the measurement equipment should be taken from a point close to the measurement port of the equipment. The connection to the earth point of the signal source should be of low impedance.
- In the case of a signal source that has no reference to earth, then that source must be placed centrally on an earthed copper or similar high conductivity metal plate of dimension greater than twice the area of the minimum rectangle bounding the perimeter of the signal source. The earth point of the measurement equipment should be taken from a point close to the measurement port of the equipment. The connection to the metal plane should be of low impedance.

11.2.2. Transmitter Balance - LOV

The balance of transmitters is normally expressed in the "Longitudinal Output Voltage" (LOV). This is the common mode portion of the generated signal, and specified for many transmission systems defined by ETSI TM6 (e.g. [8, 9]).

The longitudinal output voltage is the longitudinal component of the output signal which occurs on the line interface (ports of the local loop wiring). The definition of the LOV can be found in the ITU recommendations [23].

Figure 34 gives an example measurement method for longitudinal output voltage. Further examples can be derived from [22,23]. For direct use of this test configurations, the IUT should be able to generate a signal in the absence of a signal from the far end. The ground reference for these measurements shall be the building ground.

NOTE: During regenerator test (where required) each wire on the side which is not under test has to be connected to ground by a terminating impedance having the value of $R_T/2$ Ohms in series with a capacitance of at least 330 nF.

References [22]: [ITU:O.9],

References [23]: [ITU:G.117]

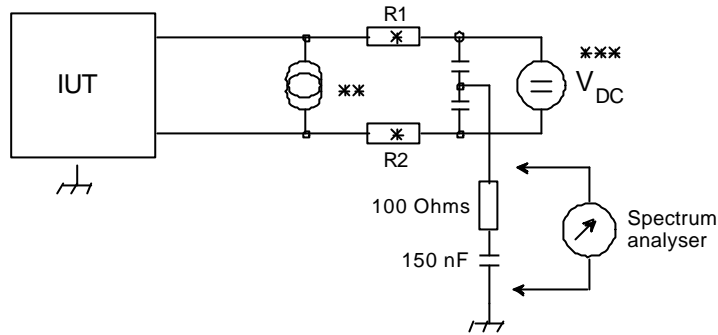

Figure 34: Measurement method for longitudinal output voltage (LOV).

* These resistors have to be matched: $R1 = R2 = R_T/2$ and $R1/R2 = 1 \pm 0,1 \%$

** For LTU test only if remote power feeding is supplied

*** For NTU test only if remote power feeding is required

DC blocking capacitors = C_B

NOTE: The value of the components C_B is to be considered carefully for the frequency range and design impedance the measuring adapter is used for. At low frequencies other measurement methods could be more appropriate.

11.2.3. Receiver Balance - LCL

The balance of receivers is normally expressed in the "Longitudinal Conversion Loss" (LCL). The definition of the LCL can be found in [22]. Additionally, LCL is specified for all transmission systems defined by ETSI TM6 (e.g. [8, 9])

The (LCL) longitudinal conversion loss is given by: $LCL = 20 \log (e_l/e_m)$ [dB] where e_l is the applied longitudinal voltage referenced to the building ground and e_m is the resultant metallic voltage appearing across a termination with the impedance as given in the relevant section (see figure 35)

Figure 35 defines an example of the measurement method for the longitudinal conversion loss (LCL). The LCL is given by: $LCL = 20 \log (e_l/e_m)$ [dB] where e_l is the applied longitudinal voltage referenced to the building ground and e_m is the resultant metallic voltage appearing across a defined termination. Measurement should be performed with the IUT powered up but inactive (no transmit signal).

References [22]: [ITU:O.9],

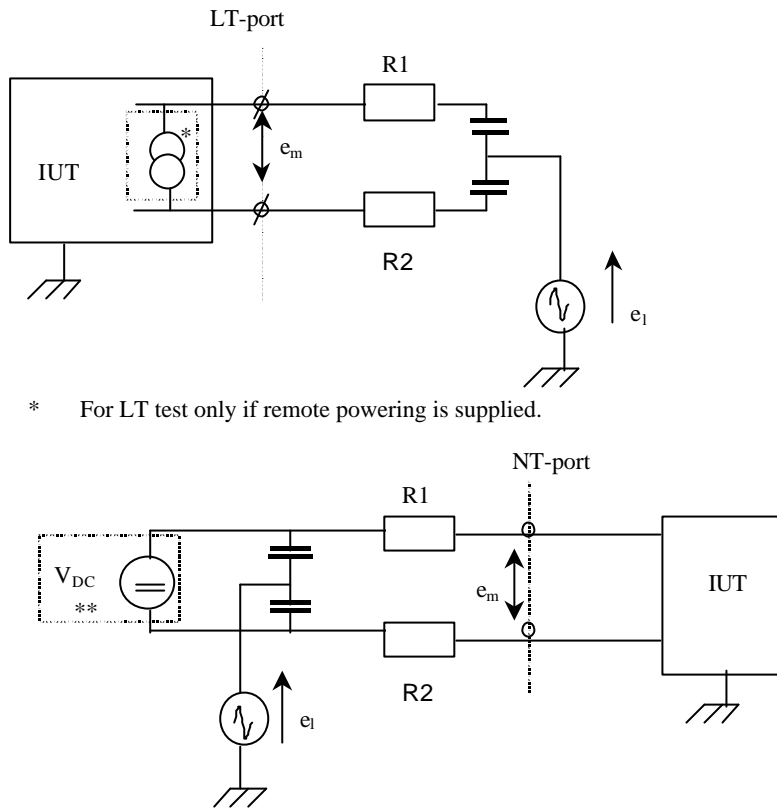

* For LT test only if remote powering is supplied.

** For NT test only if remote powering is required. The power supply shall have at least an impedance of $10 * (R1+R2)$ for the test frequencies of the LCL.

Figure 35: Measurement method for longitudinal conversion loss.

*** DC blocking capacitors = C_B

NOTE: The value of the components C_B is to be considered carefully for the frequency range and design impedance the measuring adapter is used for. At low frequencies other measurement methods could be more appropriate.

Bibliography

The following material, though not specifically referenced in the body of the present document (or not publicly available), gives supporting information.

<POTS & ANALOGUE>

- [1] **ETSI-TBR 21 (1998-01)**: "Attachment requirements for pan-European approval for connection to the analogue Public Switched Telephone Networks (PSTNs) of TE (excluding TE supporting the voice telephony service) in which network addressing, if provided, is by means of Dual Tone Multi Frequency (DTMF) signalling". ETSI, January 1998.
- [2] **ETSI-EG 201 188 (1999-06)**: "Public Switched Telephone Networks (PSTNs); Network Termination Point (NTP) analogue interface; Specification of physical and electrical characteristics at a 2-wire analogue presented NTP for short to medium length loop applications". ETSI, June 1999.
- [3] **ETSI-EN 300 001 (1998-10)**: "Attachments to Public Switched Telephone Network (PSTN); General technical requirements for equipment connected to an analogue subscriber interface in the PSTN" ETSI, Oct 1998.
- [4] **ETSI-ETS 300 450** Business Telecommunications (BTC); Ordinary and Special quality voice bandwidth 2-wire analogue leased lines (A2O and A2S); Terminal equipment interface, February 1996.
Reference: DE/BTC-02028
- [5] **ETSI-ETS 300 453** Business Telecommunications (BTC); Ordinary and Special quality voice bandwidth 4-wire analogue leased lines (A4O and A4S); Terminal equipment interface. February 1996
Reference: DE/BTC-02032

<AUDIO>

- [6] **ITU-T Recommendations N.11 to N.16**. Maintenance of international sound - programme and television circuits, 1988, (extract from the Blue Book):
Rec N.11 - Essential transmission performance objectives for international sound-programme centres (ISPC) (8)
Rec N.12 - Measurements to be made during the line-up period that precedes a sound-programme transmission (8)
Rec N.13 - Measurements to be made by the broadcasting organizations during the preparatory period (11)
Rec N.15 - Maximum permissible power during an international sound-programme transmission (7)
Rec N.16 - Identification signal (8)
- [7] **ITU-T Recommendations J.21**. (08/94) - Performance characteristics of 15 kHz-type sound-programme circuits - circuits for high quality monophonic and stereophonic transmissions (8)

<ISDN>

- [8] **ETSI-TS 102 080**: "Transmission and Multiplexing (TM); Integrated Services Digital Network (ISDN) basic rate access; Digital transmission system on metallic local lines", ETSI Technical Specification, v 1.3.1, Nov 1998

<HDSL>

- [9] **ETSI-TS 101 135** V1.5.1. (1998-11): "Transmission and Multiplexing (TM); High bit rate Digital Subscriber Line (HDSL) transmission system on metallic local lines; HDSL core specification and applications for combined ISDN-BA and 2 048 kbit/s transmission

<SDSL>

- [10] **ETSI**: "Transmission and Multiplexing (TM); Symmetric single pair high bit rate digital subscriber line (SDSL) transmission system on metallic local lines; Part 1: Functional Requirements", ETSI-TM6 workitem RE/TM-06011-1, TM6(98)08 980p08r5, Dec 1999.
- [11] **ETSI WG TM6**, 980p09a0, Permanent Document TM6(98)9, Rev. 1, Living List for DTS/TM-06011-1

<ADSL>

- [12] **ETSI-ETR 328:** "Transmission and Multiplexing (TM); Asymmetric Digital Subscriber Line (ADSL); Requirements and performance", ETSI, European Telecommunication Standard, November 1996
- [13] **ETSI TS 101 388:** "Transmission and Multiplexing (TM); Access transmission systems on metallic access cables; Asymmetric Digital Subscriber Line (ADSL) -Coexistence of ADSL and ISDN-BA on the same pair". ETSI, European Telecommunication Standard, November 1998
- [14] **ANSI-T1.413, issue 1:** "Network and customer installation interfaces - Asymmetrical Digital Subscriber Line (ADSL) Metallic Interface", ANSI, American National Standardization Institute, Issue 1, August 1995.
- [15] **ANSI-T1.413, issue 2:** "Standards Project for Interfaces Relating to Carrier to Customer Connection of Asymmetrical Digital Subscriber Line (ADSL) Equipment", ANSI, American National Standardization Institute, draft specification issue 2, T1E1.4/97-007R6, Sept 1997. (ADSL_98R5)
- [16] **ITU-T G.992.1:** "Transmission Systems and Media; Asymmetrical Digital Subscriber Line (ADSL) Transceivers" ITU-T, International Telecommunication Union", draft specification, April 1999.
- [17] **ITU-T G.992.2:** "Transmission Systems and Media; Splitterless Asymmetrical Digital Subscriber Line (ADSL) Transceivers" ITU-T, International Telecommunication Union", draft specification, Feb 1999.

<VDSL>

- [18] **ETSI-DTS/TM-06003:** "Transmission and Multiplexing (TM); Access transmission systems on metallic access cables; Very high speed Digital Subscriber Line (VDSL); Part 1: Functional requirements". ETSI, European Telecommunication Standard, draft Edition 1 revision 7, February 1998
- [19] **ANSI-T1.VDSL:** "Very high-speed Digital Subscriber Lines (VDSL)", ANSI, Draft Technical report, revision 12 T1E1.4/97-131R3, may 1997.
- [20] **ETSI-TS 101 270-1:** Transmission and Multiplexing (TM); Access transmission systems on metallic access cables; Very high speed Digital Subscriber Line (VDSL); Part 1: Functional requirements
- [21] **ETSI-TS 101 270-1 V1.2.1 (1999)** Transmission and Multiplexing (TM); Access transmission systems on metallic access cables; Very high speed Digital Subscriber Line (VDSL); Part 1: Functional requirements

<EMC & UNBALANCE>

- [22] **ITU-T Recommendation O.9.** (1988) - Measuring arrangements to assess the degree of unbalance about earth, vol IV.4-Rec O.9 (1972, amended in 1984 and 1988)
- [23] **ITU-T Recommendation G.117.**
- [24] **ETSI EN 300 386-2.** - Electromagnetic compatibility and Radio spectrum Matters (ERM); Telecommunication network equipment; ElectroMagnetic Compatibility (EMC) requirements; Part 2: Product family standard, dec 1997

<VARIOUS>

- [25] **ETSI-TM6(97)02.** "Cable reference models for simulating metallic access networks", R.F.M. van den Brink, ETSI-TM6, Permanent document TM6(97)02, revision 3, Luleå, Sweden, June 1998.
- [26] **ETSI STC TM6, TD 16** meeting, 22- 26 June 1998, Luleå, Sweden, 983t16a0, PSD + Crest factor is not sufficient to specify noise in performance tests.
- [27] **ETSI STC TM6, TD 42** meeting, 21-25 September 1998, Vienna, Austria, 984t42a0, Specification of crest distribution mask for noise in performance tests.

History

Document history		
0.0.1	feb 2000	First Draft
0.0.2	april 2000	Enhanced Reference Model (see WD22 of Montreux) ; general bugfix; Signals added (ISDN.MMS.43, HDSL.2B1Q/1, Proprietary.SymDSL.PAM); Inclusion of LOV (see WD18 of Montreux); frequencies specified as centre frequencies
0.0.3	7 june 2000	Some signal names renamed Signals added: Proprietary.SymDSL variants (PAM and 2B1Q) and Proprietary.PCM.HDB3.2M.SR. Description improved of unbalance specifications. Decimal dots replaced by decimal commas