

Transmission and Multiplexing (TM); Spectral management on metallic access networks; Part 1: Definitions and signal library

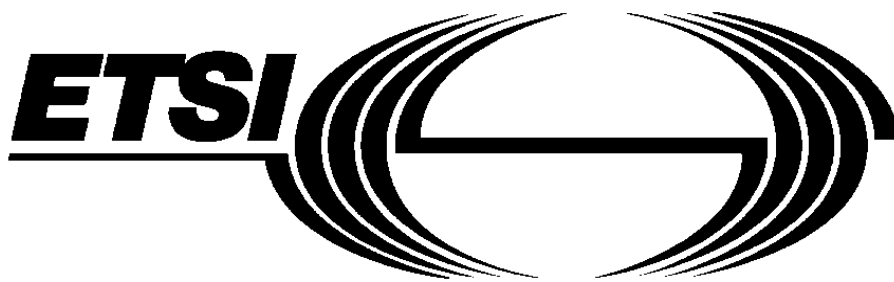

Work Item Reference DTS/TM-06020-1
Permanent Document **TM6(99)07**
Filename 990p07a6*
Date may 3rd, 2001

Rapporteur/Editor **Rob F.M. van den Brink**
 KPN Research
 PO Box 421
 2260 AK Leidschendam
 The Netherlands

tel: +31 70 4462389
fax: +31 70 4463477
email: R.F.M.vandenBrink@kpn.com

mark that above numbers have changed since feb 2001

Reference

DTR/TM-06020-1

Keywords

spectral management, unbundling, access network, local loop, transmission, modem, POTS, IDSN, ADSL, HDSL, SDSL, VDSL, xDSL**ETSI**

650 Route des Lucioles
F-06921 Sophia Antipolis Cedex - FRANCE

Tel.: +33 4 92 94 42 00 Fax: +33 4 93 65 47 16

Siret N° 348 623 562 00017 - NAF 742 C
Association à but non lucratif enregistrée à la
Sous-Préfecture de Grasse (06) N° 7803/88

Important notice

Individual copies of the present document can be downloaded from:
<http://www.etsi.org>

The present document may be made available in more than one electronic version or in print. In any case of existing or perceived difference in contents between such versions, the reference version is the Portable Document Format (PDF). In case of dispute, the reference shall be the printing on ETSI printers of the PDF version kept on a specific network drive within ETSI Secretariat.

Users of the present document should be aware that the document may be subject to revision or change of status. Information on the current status of this and other ETSI documents is available at <http://www.etsi.org/tb/status/>

If you find errors in the present document, send your comment to:
editor@etsi.fr

Copyright Notification

No part may be reproduced except as authorized by written permission.
The copyright and the foregoing restriction extend to reproduction in all media.

© European Telecommunications Standards Institute 2001.
All rights reserved.

Contents

Intellectual Property Rights	6
Foreword	6
1 Scope	7
2 References	7
3 Definition and abbreviations	9
3.1 Definitions	9
3.2 Abbreviations	10
4 The technical purpose of Spectral Management	11
4.1 Bounding spectral pollution	11
4.2 The Individual Components of Spectral Pollution	12
5 Reference model of the local loop wiring	13
5.1 The concept of a Port, the interface the Local Loop Wiring	13
5.2 Bounding Spectral Pollution by limiting signals at the Ports	13
5.3 Reference model	14
6 Minimum set of characteristics for signal descriptions	15
7 Cluster 0 Signals (DC power feeding)	16
7.1 "Class A" Power Feeding (from the LT-port)	16
7.2 "Class B" Power Feeding (from the LT-port)	16
7.3 "Class X" Power Feeding (from the LT-port)	16
7.3.1 "Class X1" Power Feeding	17
7.3.2 "Class X2" Power Feeding	17
7.3.3 "Class X3" Power Feeding	17
7.3.4 "Class X4" Power Feeding	17
7.3.5 "Class X5" Power Feeding	18
7.4 "Class Y" Power Feeding (from the LT-port)	18
7.4.1 "Class Y1" Power Feeding	18
7.4.2 "Class Y2" Power Feeding	18
8 Cluster 1 Signals (voice band)	19
8.1 "POTS" Signals (voice band lines 300 Hz to 3 400 Hz)	19
8.1.1 Total signal voltage	19
8.1.2 Peak amplitude	19
8.1.3 Narrow-band signal voltage	19
8.1.4 Unbalance about earth	20
8.1.5 Feeding Power (from the LT-port)	22
8.1.6 Reference impedance Z_R	22
8.1.7 Ringing signal	22
8.1.8 Metering signals	22
9 Cluster 2 Signals (semi broad band)	23
9.1 "ISDN.2B1Q" Signals	23
9.1.1 Total signal power	23
9.1.2 Peak amplitude	23
9.1.3 Narrow-band signal power	23
9.1.4 Unbalance about earth	24
9.1.5 Feeding Power (from the LT-port)	25
9.2 "ISDN.MMS.43" Signals	26
9.2.1 Total signal power	26
9.2.2 Peak amplitude	26
9.2.3 Narrow-band signal power	26
9.2.4 Unbalance about earth	27
9.2.5 Feeding Power (from the LT-port)	28
9.3 "Proprietary.SymDSL.CAP.QAM" Signals	28

9.3.1	Total signal power	29
9.3.2	Peak amplitude	29
9.3.3	Narrow-band signal power (NBSP).....	29
9.3.4	Unbalance about earth	30
10	Cluster 3 Signals (symmetrical broad band)	32
10.1	"HDSL.2B1Q/3" Signals (392 kbaud leased lines)	32
10.1.1	Total signal power	32
10.1.2	Peak amplitude	32
10.1.3	Narrow-band signal power.....	32
10.1.4	Unbalance about earth	33
10.1.5	Feeding Power (from the LT-port)	34
10.2	"HDSL.2B1Q/2" Signals (584 kbaud leased lines)	34
10.2.1	Total signal power	34
10.2.2	Peak amplitude	35
10.2.3	Narrow-band signal power.....	35
10.2.4	Unbalance about earth	36
10.2.5	Feeding Power (from the LT-port)	37
10.3	"HDSL.2B1Q/1" Signals (1160 kbaud leased lines)	37
10.3.1	Total signal power	37
10.3.2	Peak amplitude	38
10.3.3	Narrow-band signal power.....	38
10.3.4	Unbalance about earth	39
10.3.5	Feeding Power (from the LT-port)	40
10.4	"HDSL.CAP/2" Signals.....	40
10.4.1	Total signal power	40
10.4.2	Peak amplitude	40
10.4.3	Narrow-band signal power (NBSP).....	40
10.4.4	Unbalance about earth	41
10.4.5	Feeding Power (from the LT-port)	42
10.5	"SDSL::Fn" Signals.....	43
10.5.1	Total Signal Power	43
10.5.2	Peak amplitude	44
10.5.3	Narrow-band signal power (NBSP).....	44
10.5.4	Unbalance about earth	45
10.5.5	Feeding Power (from the LT-port)	46
10.6	"SDSL.asym::Fn" Signals	47
10.6.1	Total Signal Power	47
10.6.2	Peak amplitude	48
10.6.3	Narrow-band signal power (upstream only).....	48
10.6.4	Narrow-band signal power (downstream only).....	50
10.6.5	Unbalance about earth	51
10.6.6	Feeding Power (from the LT-port)	51
10.7	"Proprietary.SymDSL.CAP.A::Fn" Signals	52
10.7.1	Total signal power	52
10.7.2	Peak amplitude	52
10.7.3	Narrow-band signal power (NBSP).....	53
10.7.4	Unbalance about earth	54
10.8	"Proprietary.SymDSL.CAP.B::Fn" Signals.....	55
10.8.1	Total signal power	56
10.8.2	Peak amplitude	56
10.8.3	Narrow-band signal power (NBSP).....	56
10.8.4	Unbalance about earth	57
10.9	"Proprietary.SymDSL.CAP.C::Fn" Signals.....	58
10.9.1	Total signal power	59
10.9.2	Peak amplitude	59
10.9.3	Narrow-band signal power (NBSP).....	59
10.9.4	Unbalance about earth	60
10.10	"Proprietary.SymDSL.PAM::Fn" Signals	62
10.10.1	Total Signal Power	62
10.10.2	Peak amplitude	63

10.10.3	Narrow-band signal power (NBSP).....	63
10.10.4	Unbalance about earth	64
10.10.5	Feeding Power (from the LT-port)	65
10.11	"Proprietary.SymDSL.2B1Q::Fn" Signals	66
10.11.1	Total Signal Power	66
10.11.2	Peak amplitude	66
10.11.3	Narrow-band signal power (NBSP).....	66
10.11.4	Unbalance about earth	68
10.11.5	Feeding Power (from the LT-port)	69
10.12	"Proprietary.PCM.HDB3.2M.SR" Signals.....	69
10.12.1	Total signal power	69
10.12.2	Peak amplitude	69
10.12.3	Narrow-band signal power.....	69
10.12.4	Unbalance about earth	70
10.12.5	Feeding Power (from the LT-port)	71
10.13	"Proprietary.PCM.HDB3.2M.SQ" Signals	72
10.13.1	Total signal power	72
10.13.2	Peak amplitude	72
10.13.3	Narrow band signal power.....	72
10.13.4	Unbalance about earth	73
11	Cluster 4 Signals (asymmetrical broad band).....	73
11.1	"ADSL over POTS" Signals.....	73
11.1.1	Total signal power (downstream only)	74
11.1.2	Total signal power (upstream only)	74
11.1.3	Peak amplitude (upstream and downstream)	74
11.1.4	Narrow-band signal power (downstream only).....	74
11.1.5	Narrow-band signal power (upstream only).....	76
11.1.6	Unbalance about earth (upstream and downstream)	77
11.2	"ADSL over ISDN" Signals.....	78
11.2.1	Total signal power (downstream only)	78
11.2.2	Total signal power (upstream only)	78
11.2.3	Peak amplitude (upstream and downstream)	78
11.2.4	Narrow-band signal power (downstream only).....	79
11.2.5	Narrow-band signal power (upstream only).....	80
11.2.6	Unbalance about earth (upstream and downstream)	81
11.3	"ADSL.FDD over POTS" Signals.....	82
11.4	"ADSL.FDD over ISDN" Signals	83
12	Cluster 5 Signals (broad band up to 30 MHz).....	83
12.1	"VDSL" Signals	83
13	Measurement methods of signal parameters	83
13.1	Peak Amplitude.....	83
13.2	Narrow-band signal power (voltage).....	83
13.3	Unbalance about earth.....	84
13.3.1	Definition of earth	84
13.3.2	Transmitter Balance - LOV	84
13.3.3	Receiver Balance - LCL	85
	Bibliography	87
	History	88

Intellectual Property Rights

IPRs essential or potentially essential to the present document may have been declared to ETSI. The information pertaining to these essential IPRs, if any, is publicly available for **ETSI members and non-members**, and can be found in ETSI SR 000 314: "*Intellectual Property Rights (IPRs); Essential, or potentially Essential, IPRs notified to ETSI in respect of ETSI standards*", which is available from the ETSI Secretariat. Latest updates are available on the ETSI Web server (<http://www.etsi.org/ipr>).

Pursuant to the ETSI IPR Policy, no investigation, including IPR searches, has been carried out by ETSI. No guarantee can be given as to the existence of other IPRs not referenced in ETSI SR 000 314 (or the updates on the ETSI Web server) which are, or may be, or may become, essential to the present document.

Foreword

This Technical Report (TR) has been produced by ETSI Technical Committee Transmission and Multiplexing (TM).

The present document is part 1 of a multi-part deliverable covering spectral management on metallic access networks, as identified below:

Part 1: "Definitions and signal library".

Further parts are under preparation.

1 Scope

The present document gives guidance on a common language for Spectral Management specifications. It provides a first set of definitions on Spectral Management quantities, including:

- a) a description of the technical purpose of Spectral Management;
- b) a common reference model to identify LT-ports, NT-ports, upstream, downstream, etc.;
- c) a minimum set of characteristics necessary to describe signals within the context of Spectral Management; and
- d) an informative library of electrical signals that may flow into the ports of a metallic access network.

The present document is applicable to simplify & harmonize the description of *network specific* Spectral Management documents. The objective is to be a clear reference for these documents, without making any specific choice on the technology mix that may use the access network. Network-specific documents, that rule the selected penetration limits and technology mix for Spectral Management purposes, can be kept compact by referring to the definitions in the present document.

The informative library of signal definitions is organized in clusters of signal categories. Each category defines, independent from other categories, a full set of signal limits between DC and 30 MHz. These categories are dominantly based on transmission equipment standards from ETSI, ITU and ANSI (existing or in progress), and on the technical understanding of additional requirements to protect future technology. When these definitions are incomplete or not appropriated, *network specific* spectral management documents may use additional definitions.

The characteristics of each signal described in this signal library identify their absolute maximum (or minimum) values. They fully account for the spread in their actual value, unless this tolerance is explicitly specified. This means in practice that when a power limit of a signal category is specified by a single number (for instance 14 dBm), it refers to its nominal maximum power plus its tolerance (for instance 13,5 dBm \pm 0,5 dBm). This approach provides clear criteria to determine if a signal under test is compliant or not with a signal category from this library.

2 References

For the purposes of the present document, the following references apply:

POTS & ANALOGUE

- [1] ETSI TBR 21 (1998): "Attachment requirements for pan-European approval for connection to the analogue Public Switched Telephone Networks (PSTNs) of TE (excluding TE supporting the voice telephony service) in which network addressing, if provided, is by means of Dual Tone Multi Frequency (DTMF) signalling".
- [2] ETSI EG 201 188 (V1.1.1): "Public Switched Telephone Network (PSTN); Network Termination Point (NTP) analogue interface; Specification of physical and electrical characteristics at a 2-wire analogue presented NTP for short to medium length loop applications".
- [3] ETSI EN 300 001 (V1.5.1): "Attachments to the Public Switched Telephone Network (PSTN); General technical requirements for equipment connected to an analogue subscriber interface in the PSTN".
- [4] ETSI ETS 300 450 (1996): "Business TeleCommunications (BTC); Ordinary and Special quality voice bandwidth 2-wire analogue leased lines (A2O and A2S); Terminal equipment interface".
- [5] ETSI ETS 300 453 (1996): "Business TeleCommunications (BTC); Ordinary and Special quality voice bandwidth 4-wire analogue leased lines (A4O and A4S); Terminal equipment interface".

AUDIO

- [6] ITU-T Recommendation N.11: "Essential transmission performance objectives for international sound-programme centres (ISPC)".
- [7] ITU-T Recommendation N.12: "Measurements to be made during the line-up period that precedes a sound-programme transmission".
- [8] ITU-T Recommendation N.13: "Measurements to be made by the broadcasting organizations during the preparatory period".
- [9] ITU-T Recommendation N.15: "Maximum permissible power during an international sound-programme transmission".
- [10] ITU-T Recommendation N.16: "Identification signal".
- [11] ITU-T Recommendations J.21 (08/94): "Performance characteristics of 15 kHz-type sound-programme circuits - Circuits for high quality monophonic and stereophonic transmissions".

ISDN

- [12] ETSI TS 102 080 (V1.3.2): "Transmission and Multiplexing (TM); Integrated Services Digital Network (ISDN) basic rate access; Digital transmission system on metallic local lines".

HDSL

- [13] ETSI TS 101 135 (V1.5.3): "Transmission and Multiplexing (TM); High bit-rate Digital Subscriber Line (HDSL) transmission systems on metallic local lines; HDSL core specification and applications for combined ISDN-BA and 2 048 kbit/s transmission".

SDSL

- [14] ETSI TS 101 524-1: "Transmission and Multiplexing (TM); Access transmission system on metallic access cables; Symmetrical single pair high bitrate Digital Subscriber Line (SDSL); Part 1: Functional requirements".
- [15] ETSI TS 101 524-2: "Transmission and Multiplexing (TM); Access transmission system on metallic access cables; Symmetrical single pair high bit rate Digital Subscriber Line (SDSL); Part 2: Transceiver requirements".
- [16] ITU-T Recommendation G.991.2 (draft): "Single-pair high-speed digital subscriber line (SHDSL) transceivers".

ADSL

- [17] ETSI ETR 328 (1996): "Transmission and Multiplexing (TM); Asymmetric Digital Subscriber Line (ADSL); Requirements and performance".
- [18] ETSI TS 101 388 (V1.1.1): "Transmission and Multiplexing (TM); Access transmission systems on metallic access cables; Asymmetric Digital Subscriber Line (ADSL) - Coexistence of ADSL and ISDN-BA on the same pair [ANSI T1.413 - 1998, modified]".
- [19] ANSI T1.413, issue 1, (1995): "Network and customer installation interfaces - Asymmetrical Digital Subscriber Line (ADSL) Metallic Interface".
- [20] ANSI T1.413, issue 2 (1997): "Standards Project for Interfaces Relating to Carrier to Customer Connection of Asymmetrical Digital Subscriber Line (ADSL) Equipment".
- [21] ITU-T Recommendation G.992.1 (1999): "Asymmetric digital subscriber line (ADSL) transceivers".
- [22] ITU-T Recommendation G.992.2 (1999): "Splitterless asymmetric digital subscriber line (ADSL) transceivers".

VDSL

- [23] ETSI TS 101 270-1 (V1.2.1): "Transmission and Multiplexing (TM); Access transmission systems on metallic access cables; Very high speed Digital Subscriber Line (VDSL); Part 1: Functional requirements". Oct 1999
- [24] ANSI T1E1.4 VDSL: "Very high-speed Digital Subscriber Lines (VDSL) Metallic Interface", Technical report;
Part 1 (draft): "Functional Requirements and Common Specification", T1E1.4/2000- 009R3, feb 2001;
Part 2 (draft): "Technical Specification for a Single-Carrier Modulation (SCM) Transceiver", T1E1.4/2000-011R3, feb 2001;
Part 3 (draft): "Technical Specification of a Multi-Carrier Modulation Transceiver", T1E1.4/2000-013R4, nov 2000.

EMC & UNBALANCE

- [25] ITU-T Recommendation O.9 (1988): "Measuring arrangements to assess the degree of unbalance about earth".
- [26] ITU-T Recommendation G.117: "Transmission aspects of unbalance about earth".
- [27] ETSI EN 300 386-2 (V1.1.3): "Electromagnetic compatibility and Radio spectrum Matters (ERM); Telecommunication network equipment; ElectroMagnetic Compatibility (EMC) requirements; Part 2: Product family standard".

VARIOUS

- [28] EN 60950: "Safety of information technology equipment".
- [29] ETSI R0BT-002/EG 201 212 (V1.2.1): "Electrical safety; Classification of interfaces for equipment; to be connected to telecommunication networks"; CENELEC Report/ETSI Guide; (1998-11)
- [30] ITU-T Recommendation K.50

3 Definition and abbreviations

3.1 Definitions

For the purposes of the present document, the following terms and definitions apply:

network owner: company owning the telecommunication access network. (Mostly incumbent telecommunication network operators)

network operator: company that make use of the access network of the Network owner, to transport telecommunication services

transmission technique: electrical technique used for the transportation of information over electrical wiring

transmission equipment: equipment connected to the access network that uses a transmission technique to transport information

Line Termination Port (LT-port): port between network transmission equipment and the twisted pair access network, which is labelled by the network owner as "LT-port". Such a port is commonly located near the telecommunication exchange

Network Termination Port (NT-port): port between network transmission equipment and the twisted pair access network, which is labelled by the network owner as "NT-port". Such a port is commonly located at the customer premises

upstream transmission: transmission direction from an NT-port to an LT-port, usually from the customer premises, via the access network, to the telecommunication exchange

downstream transmission: transmission direction from an LT-port to an NT-port, usually from the telecommunication exchange via the access network, to the customer premises

degree of penetration: number and mixture of connected transmission techniques to the ports of a binder or cable bundle, that inject signals into the access network

3.2 Abbreviations

For the purposes of the present document, the following abbreviations apply:

ADSL	Asymmetrical Digital Subscriber Line
BRA	Basic Rate Access
CSS	Customer-side signal source
CAP	Carrier Amplitude Modulation
CDSL	Customer Digital Subscriber Line
DC	Direct Current
EMC	Electro Magnetical Compatibility
ESS	Exchange-side signal source
FDD	Frequency Division Duplexing
HDSL	High bitrate Digital Subscriber Line
ISDN	Integrated Services Digital Network
LCL	Longitudinal Conversion Loss
LOV	Longitudinal Output Voltage
LT-port	Line Termination port
LVD	Low Voltage Directive
MDF	Main Distribution Frame
NBSP	Narrow band signal power
NBSV	Narrow band signal voltage
NT-port	Network Termination port
NTE	Network Terminal Equipment
NTI	Network Terminal Interface
OLO	Other Licensed Operator
ONP	Open Network Provision
PCM	Pulse Code Modulation
PSD	Power Spectral Density
POTS	Plain Old Telephony Services
PSTN	Public Switched Telephone Network
R&TTE	Radio and Telecommunications Terminal Equipment
RMS	Root Mean Square
SDSL	Symmetrical (single pair high bitrate) Digital Subscriber Line
TBR	Technical Basis for Regulation
UNI	User Network Interface
U-ADSL	Universal Asymmetrical Digital Subscriber Line
VDSL	Very high bit rate Digital Subscriber Line
xDSL	(all systems) Digital Subscriber Line

4 The technical purpose of Spectral Management

Connecting a signal to a wire pair of a (metallic) access network cable, causes that parts of that signal couple to other wire pairs in the same cable bundle or binder group. Connecting more systems to the same cable will increase the total crosstalk noise level in each wire-pair, and disturbs systems that were already installed.

Existing access network cables are designed to facilitate a low crosstalk coupling at low frequencies (telephony band), but the frequency of signals in cables increases substantially due to the introduction of broadband transmission systems. The consequence will be a substantially increase of the total crosstalk noise power in each wire pair.

Existing transmission systems are designed to cope (to some extent) with this type of impairment, but impairment puts anyhow a limit on the capacity of what can be transported through that cable. Capacity means here the maximum bitrate that can be transported over a single wire-pair at given cable length, or the maximum length that can be reached at given bitrate. Above some impairment level, the reliability of installed systems becomes poor, and they will even fail when the impairment level is increased further.

Usually, systems are designed to function optimally when they are only impaired by identical systems (self-crosstalk) that use other wire-pairs in the same cable. In practice, it is quite common to mix different transmission technologies in one cable. This may cause some degradation of transmission capacity, compared to the above mentioned idealized situation:

- if this degradation is minor, the technology mix is referred to as *compatible*;
- if this degradation is acceptable, the technology mix is referred to as *near-compatible*;
- if this degradation is not-acceptable, the technology mix is referred to as *incompatible*.

To prevent that only a few systems make an inefficient use of the access network, at the cost of all the others, measures have to be taken. This is referred to as "Spectral Management".

4.1 Bounding spectral pollution

The objective for *spectral management* is to control the maximum spectral pollution, to enable an efficient use of the access network for all connected systems. This can be achieved by focussing on the use of near-compatible systems in the *same cable* or cable bundle.

Spectral management is an issue for both the network owner and the network operator (in some cases they are within the same organization).

- The best that an *access network owner* can do to help the network operator(s) on its network, is to bound the spectral pollution in its network. This can be achieved by putting limits on signals (levels, spectra), diversity (technology mix) and penetration (number of systems). These limits may be dependent on the loop length. Defining relevant limits at the boundaries (or ports) of the access network is the most appropriate approach. This approach is not restricted to situations where more than one licence operator make use of the same binders or cable bundles; it is also essential when one operator mixes different broadband technologies into one binder or cable bundle.
- The best that *network operators* can do is making estimates of the maximum impairment level in a wire-pair, and define adequate deployment rules. Deployment rules define the maximum reach or bitrate for a given transmission technology, with 'sufficient' noise margin (according to the network operator). Since the crosstalk coupling between the wire pairs in binders or cable bundles is only known by a very rough approximation, the maximum impairment level is also only known by a very rough estimate. In other words: the definition of adequate limits is an essential requirement for successful deployment rules, but it can never *guarantee* that deployment rules can be adequate under all conditions. It is an inconvenience which each network operator has to face.

The present document provides an informative library of signal categories, to simplify spectral management specifications that bound the spectral pollution of a network. Guidelines for deployment rules are beyond the scope of the present document. A spectral management specification of a possible length dependency of the signal limits is also beyond the scope of the present document.

4.2 The Individual Components of Spectral Pollution

Defining adequate rules for controlling spectral pollution requires a technical understanding of how individual disturbers contribute to the total impairment. The crosstalk coupling functions and the attenuation characteristics of an existing access network are fixed and from an electrical point of view the network can be considered as a closed entity. Controlling the spectral pollution is therefore restricted to controlling what signals may, and may not, flow into the access network cables.

Figure 1 illustrates the impact of these cable characteristics on the transmission. Transceiver TR1.LT sends information to TR1.NT.

- Receiver TR1.NT receives the downstream signal from transmitter TR1.LT, that has been attenuated by the insertion loss of the wire-pair.
- In addition, TR1.NT receives crosstalk noise through the NEXT coupling function (near end crosstalk), from the upstream signal transmitted by TR2.NT.
- In addition, TR1.NT receives crosstalk noise through the FEXT coupling function (far end crosstalk), from the downstream signal transmitted by TR2.LT.

This crosstalk noise deteriorates the signal to noise ratio of the received signal, and therefore the performance of the transmission between TR1.LT and TR1.NT.

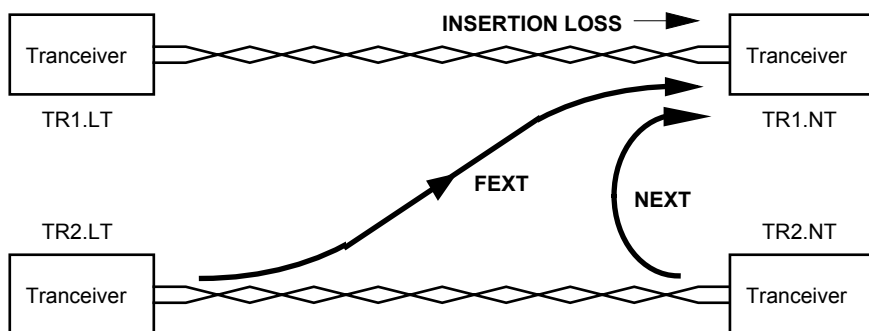

Figure 1: Various crosstalk paths

Crosstalk and attenuation characteristics are frequency dependent. Because of the differences in crosstalk coupling at the near and the far end, the relation between frequency allocation and sending direction is of major importance for the management of the crosstalk noise.

The crosstalk coupling to the far end of the transmitter (FEXT) is relatively low due to the attenuation. The crosstalk on the near end (NEXT) will be relatively high. So if the transmitter and the receiver at one end of the line would use the same frequency band, the transmitter outputs should be limited in order not to disturb the adjacent receivers. The result would be that the achievable wire-pair length would be limited because crosstalk limits the maximum allowed sending level. By using different frequency bands for transmitters and receivers at one end of the binder or cable bundle, this effect can be eliminated and the achievable length will increase.

NOTE 1: Some systems, such as FDD-based ADSL, take advantage from allocating different frequency bands for transmitting signals in upstream and downstream direction. By using spectra that are only partly overlapped (echo-cancelled systems), or not overlapped at all (FDD-systems), the NEXT between these systems can be reduced significantly. Ideally, if there is no spectral overlap between up and downstream signals, and the binder or cable bundle is only filled with these systems, the transmission performance becomes FEXT-limited only since all NEXT has been eliminated.

NOTE 2: Consider the example of FEXT-limited ADSL: the NEXT at the NT due to neighbouring HDSL systems can limit the ADSL downstream performance. By restricting the deployment distance of HDSL, the NEXT disturbance at the NT of longer ADSL lines will be attenuated by the extra cable length, increasing the ADSL capacity (or reach for a given capacity). It follows that the deployment range limit of HDSL systems has an impact on the deployment range limit of ADSL. This example shows that it may be desirable to make the specifications for the signal limits dependent on the loop length.

5 Reference model of the local loop wiring

This clause describes the reference model of the *local loop wiring* of an access network, from a spectral management point of view. It illustrates that local loop cable sections are asymmetrical in nature, because equipment near the local exchange side may differ from equipment near the customer side.

The Local Loop Wiring (LLW) of an access network includes mainly cables, but may also include a Main Distribution Frame (MDF), street cabinets, and other distribution elements.

From a Spectral Management point of view, signal sources are identified on their location:

CSS:	Customer-side Signal Sources
ESS:	Exchange-side Signal Sources (such as local exchanges)
RSS:	Remote Signal Sources (such as repeaters and optical network units in street cabinets)

5.1 The concept of a Port, the interface the Local Loop Wiring

To give signal sources access to the Local Loop Wiring, their signals enter the LLW by flowing through so-called "ports". The ports are the interfaces to the Local Loop Wiring, and should therefore be well identified.

The following port-types are defined in this reference model:

- **LT-port:** the Line Termination port is generally used for connecting an ESS to the LLW.
- **NT-port:** the Network Termination port is generally used for connecting an CSS to the LLW.
- **LT.cab-port:** the LT-cabinet port is generally used for connecting an RSS to the LLW, that links this port with an NT-port (or NT.cab-port) elsewhere in the LLW.
- **NT.cab-port:** the NT-cabinet port is generally used for connecting an RSS to the LLW, that links this port with an LT-port (or LT.cab-port) elsewhere in the LLW.

At least two ports are required for communication. In special cases where access to the LLW at additional *well-identified* ports (such as in street cabinets) is provided for remote active devices (such as repeaters and optical network units), more ports may be involved.

5.2 Bounding Spectral Pollution by limiting signals at the Ports

The signal limits that are summarized in the present document, are to limit injected signals as they can be observed at the ports of the LLW.

The signals that many DSL systems generate are asymmetrical in nature. For instance ADSL systems generate different data signals in different transmission directions. ISDN and HDSL systems are symmetrical in their data signals, but their remote DC power feeding is asymmetrical. Therefore different port names are used in the Reference Model to simplify the description of signal limits that are transmission direction dependent.

NOTE 1: Reversing the transmission direction is generally not recommended, and may be implicitly forbidden by asymmetric signal limits at the ports. For example, ADSL systems are designed to maximize self-compatibility when all 'downstream' signals in one cable flow into the same direction. Typically connection of one system the other way round would harm neighbouring systems unacceptably, and is excluded when it violates the limits.

In the case of symmetric signal limits, no further distinction on transmission direction is made. In the case of asymmetric signal limits, the following naming convention is used in the present document:

- **Downstream** signal limits are mandatory for signals that are injected into an LT-port (or LT.cab-port) of the Local Loop Wiring. LT-ports are usually located at the central office side of the local loop wiring.

- **Upstream** signal limits are mandatory for signals that are injected into an NT-port (or NT.cab-port) of the Local Loop Wiring. NT-ports are usually located at the customer side.

For each port, it must be well-identified if this is an LT- or NT-port, and which signal limits are mandatory for these ports.

NOTE 2: An example of unintended reversal of transmission direction may occur when the main distribution frame (MDF) of another licensed operator is not co-located with the MDF of the network owner (at the local exchange). If some of the wire pairs of a distribution cable are used for connecting these two MDF's, then upstream and downstream signals in different wire pairs have to flow in the same cable direction. In such a case, a so-called tie-cable can solve the problem. Such a tie-cable should be fully dedicated to this purpose, and fully *separated* from the standard distribution cables.

NOTE 3: Signal limits need not be the same for all NT-ports or LT-ports. It is conceivable that the signal limits depend on e.g. the loop length. A specification of this possible length dependence is beyond the scope of the present document.

5.3 Reference model

Figure 2 shows a generic reference model of the Local Loop Wiring (LLW), from a Spectral Management point of view. The signals of various Signal Sources connected to the LLW flow into the LLW through *well-identified* ports. The following naming convention is used:

- The signals that flow through an *LT-port* into the Local Loop Wiring have their origin in a *Exchange-side Signal Source* (ESS), such as for instance a local exchange. When signal limits are direction dependent, the signals labelled in the present document as *downstream* are intended for injection into these LT-ports, unless explicitly stated otherwise.
- The signals that flow through an *NT-port* into the Local Loop Wiring have their origin in a *Customer-side Signal Source* (CSS). When signal limits are direction dependent, the signals labelled in the present document as *upstream* signals are intended for injection into these NT-ports, unless explicitly stated otherwise.
- The signals that flow through an optional *LT.cab-port* or *NT.cab-port* into the Local Loop Wiring have their origin in *Remote Signal Sources* (RSS). Their signal limits may be different from the limits that hold for LT-ports and NT-ports.

This model enables the identification of upstream and downstream directions. Furthermore, a distinction between NT-ports may be made on the basis of the loop length, when specifying signal limits on the ports.

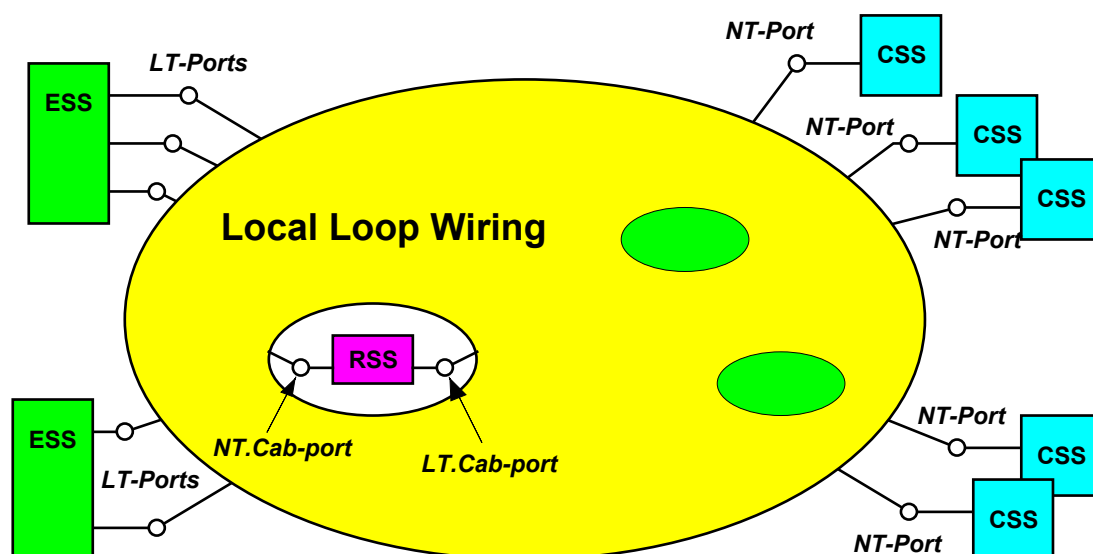

CSS: Customer-side Signal Source
 ESS: Exchange-side Signal Source
 RSS: Remote Signal Source
 LT-port: Line Termination Port, for injecting downstream signals from a ESS
 NT-port: Network Termination Port, for injecting upstream signals from a CSS
 LT.cab-port: LT-cabinet Port, for injecting downstream signals from a RSS
 NT.cab-port: NT-cabinet Port, for injecting upstream signals from a RSS

Figure 2: Reference model of the local loop wiring of an access network. This model enables the definition of upstream and downstream directions. Furthermore, a distinction between NT-ports may be made on the basis of the loop length, when specifying signal limits on the ports

NOTE: "Connecting a Signal Source to a port of the Local Loop Wiring", does not necessary mean "intended for transmission through that local loop wiring". For instance, in-house transmission equipment (such as home-PNA), may use existing in-house telephony wires, so they are also "connected to the local loop wiring". They will (unintentional) inject signals into the Local Loop Wiring via the NT-ports. These signals are subject to the signal limits at the ports.

6 Minimum set of characteristics for signal descriptions

To classify signals for spectral management purposes, the following parameters are relevant:

- Total signal voltage (or power);
- Peak amplitude;
- Narrow-band signal voltage (or power);
- Unbalance about earth (LOV and LCL);
- Feeding Power (if relevant).

In some cases, additional parameters are required, such as feeding requirements (in case of remote powering) and ringing signals.

7 Cluster 0 Signals (DC power feeding)

This cluster summarizes maximum DC feeding voltages and currents, used for remote powering of transmission equipment (including POTS, ISDN, HDSL and SDSL). Feeding voltages and currents are to be limited for reasons like safety requirements, preventing damage to equipment and devices, and/or additional national requirements.

These DC power feeding limits are supplementary to the AC signal descriptions in the succeeding cluster 1 to 5. By referring to both kind of signal descriptions, the simultaneous use of AC signals and DC power feeding over the same wire pair can be enabled.

7.1 "Class A" Power Feeding (from the LT-port)

This category covers feeding voltages and currents that will not exceed the requirements relevant for safety, as can be found in ETSI [29] and Cenelec [28] safety standards for TNV-3 circuits. TNV-3 circuits have an operating voltage limit defined as a combination of the maximum DC-voltage and the peak AC-voltage, and may be subjected to overvoltages from the telecommunication network.

TNV-3 circuits may be touched by users on a limited area of contact.

To be compliant with this signal, the combination of the DC power feeding and AC peak signal shall not exceed the limits in Table 1, and all requirements in [29] and [28] for TNV-3 circuits.

Reference [29]: EG 201 212

Reference [28]: EN 60960

Table 1: Maximum values for "Class A" power feeding

Voltage	$U_{dc}/120 + U_{ac,peak}/70,7 \leq 1$	V
Current		mA
Power		mW

7.2 "Class B" Power Feeding (from the LT-port)

This category covers feeding voltages and currents that will not exceed the requirements relevant for safety as can be found in ITU [30] safety standards for RTF circuits (Remote Feeding Telecommunication) V-3 circuits. RTF circuit has an operating voltage limit defined as a combination of the maximum DC-voltage and the peak AC-voltage, and may be subjected to overvoltages from the telecommunication network.

To be compliant with this signal, the combination of the DC power feeding and AC peak signal shall not exceed the limits in table 2, and all requirements in [30] for RTF circuits.

Reference [30]: ITU-T rec. K.50

Table 2: Maximum values for "Class B" power feeding

Voltage		V
Current		mA
Power		mW

7.3 "Class X" Power Feeding (from the LT-port)

This category covers feeding voltages and currents that will not exceed the requirements relevant for various ETSI, ITU or ANSI standards on xDSL equipment.

7.3.1 "Class X1" Power Feeding

This category covers applications like remote powering POTS services. To be compliant with this signal category, the DC feeding voltage and feeding current shall not exceed the maximum values in table 3.

Reference: EG 201 188 [2], subclauses 6.2.1 and 6.3.1.

Reference: EN 300 001 [3], subclause 1.5.

Table 3: Maximum values for "Class X1" power feeding

	Maximum Voltage	Maximum Current
EG 201 188 [2]	78 V	55 mA

7.3.2 "Class X2" Power Feeding

This category covers applications like remote powering ISDN.2B1Q services. To be compliant with this signal category, the DC feeding voltage and feeding current shall not exceed the maximum values in table 4. The value for power includes a possible overload or short circuit condition at the user-network interface.

Reference: TS 102 080 [12], subclauses 10.5 and 10.6.1.1.

Table 4: Maximum values for "Class X2" power feeding

Voltage	Current	Power at NT-port
Maximum 99 V	40 mA	maximum 1100 mW

7.3.3 "Class X3" Power Feeding

This category covers applications like remote powering ISDN.MMS.43 services. To be compliant with this signal category, the DC feeding voltage and feeding current shall not exceed the maximum values in table 5. The value for power includes a possible overload or short circuit condition at the user-network interface.

Reference: TS 102 080 [12], subclauses 10.5 and 10.6.1.1.

Table 5: Maximum values for "Class X3" power feeding

Voltage	Current	Power at NT-port
Maximum 99 V	Maximum 55 mA	maximum 1100 mW

7.3.4 "Class X4" Power Feeding

This category covers applications like remote powering HDSL services. To be compliant with this signal category, the DC feeding voltage and feeding current shall not exceed the maximum values in table 6. The value for power includes a possible overload or short circuit condition at the user-network interface.

Reference: TS 101 135 [13], subclause 9.2.

Table 6: Maximum values for "Class X4" power feeding

Voltage SUM (DC feeding + AC signal)	Current
maximum 120 V	50 mA

7.3.5 "Class X5" Power Feeding

This category covers applications like remote powering SDSL services. To be compliant with this signal category, the DC feeding voltage and feeding current shall not exceed the maximum values in table 7. The value for power includes a possible overload or short circuit condition at the user-network interface.

Reference: ETSI TS 101 524-1 [14], clause 11

Reference: ITU G.991.2 (draft) [16], clause B.5.3

Table 7: Maximum values for "Class X5" power feeding.

Voltage	Current	Power NT-Port
Maximum TBD V (see EN60950)	TBD mA	Maximum TBD mW

7.4 "Class Y" Power Feeding (from the LT-port)

This category covers feeding voltages and currents that will not exceed the requirements relevant for proprietary equipment, not covered by ETSI, ITU or ANSI standards

7.4.1 "Class Y1" Power Feeding

This category covers applications like remote powering "Proprietary.SymDSL.PAM"-based services. To be compliant with this signal category, the DC feeding voltage and feeding current shall not exceed the maximum values in table 8. The value for power includes a possible overload or short circuit condition at the user-network interface.

NOTE 1: The values in table 8 represent values of a typical European application, Other voltage up to 190 V can be supported.

NOTE 2: No ETSI deliverable does specify this parameter.

Table 8: Maximum feeding requirements for the leased line service over proprietary.SymDSL.PAM::Fn"

Voltage	Current	Power NT-Port
Maximum 115 V (see EN 60950)	Maximum 55 mA	Maximum 1100 mW

7.4.2 "Class Y2" Power Feeding

This category covers applications like remote powering "Proprietary.PCM.HDB3"-based services. To be compliant with this signal category, the DC feeding voltage and feeding current shall not exceed the maximum values in table 9. The value for power includes a possible overload or short circuit condition at the user-network interface.

Table 9: Maximum feeding requirements for the leased line service over "Proprietary.PCM.HDB3"

Voltage	Current
Maximum 120 V between both DC-shortened Wire pairs	59 mA

8 Cluster 1 Signals (voice band)

This cluster summarizes signals that are generated by analogue transmission equipment (including POTS), voice band modems, analogue leased lines, telex signals encoded as voice band signals and music lines.

8.1 "POTS" Signals (voice band lines 300 Hz to 3 400 Hz)

This category covers signals from telephony transmission equipment (e.g. telephones, voice band modems, Faxes, analogue leased lines etc.) on a single wire pair. Unless other specified, the requirements on DTMF-signals (Dual Tone Multi-Frequency), as defined in [1], are equal to the voice signal.

A signal can be classified as a "POTS signal" if it is compliant with all subclauses below.

8.1.1 Total signal voltage

To be compliant with this signal category, the mean signal voltage over a reference impedance Z_R (see figure 5) shall not exceed a level of $-9,7$ dBV, measured within a frequency band from at least 200 Hz to 3,8 kHz, and over a one-minute period. This requirement does not apply to DTMF signals.

Reference: TBR 21 [1], subclause 4.7.3.1, (tested according to subclause A.4.7.3.1).

To be compliant with this signal category, the level of any tone in the DTMF high frequency group shall not be greater than $-9,0$ dBV + $2,0$ dB = $-7,0$ dBV. The level of any tone in the low frequency group shall not be greater than $-11,0$ dBV + $2,5$ dB = $-8,5$ dBV. This is to be measured when the TE interface is terminated with the specified reference impedance Z_R (see figure 5).

Reference: TBR 21 [1], subclause 4.8.2.2., (tested according to subclause A.4.8.2.2).

8.1.2 Peak amplitude

To be compliant with this signal category, the peak to peak signal voltage over a reference impedance Z_R (see figure 5) shall not exceed a level of 5,0 volts, measured within a frequency band from at least 200 Hz to 3,8 kHz. The definition and measurement method of peak amplitude is specified in sub clause 13.1.

Reference: TBR 21 [1], subclause 4.7.3.2, (tested according to subclause A.4.7.3.2).

8.1.3 Narrow-band signal voltage

To be compliant with this signal category, the narrow-band signal voltage (NBSV) shall not exceed the limits given in table 10, at any point in the frequency range 100 Hz to 30 MHz. This table specifies the break points of these limits, in which Z_R refers to the specified reference impedance Z_R (see figure 5). Limits for intermediate frequencies can be found by drawing a straight line between the break points on a logarithmic (Hz) - linear (dB) scale. Figure 3 illustrates the NBSV in a bandwidth-normalized way.

The NBSV is the average rms-voltage U of a sending signal into a (complex) load impedance Z , within a **power** bandwidth B . The measurement method of the NBSV is described in subclause 13.2.

Reference: TBR 21 [1], (30 Hz to 4,3 kHz, subclause 4.7.3.3), (4,3 kHz to 200 kHz, subclause 4.7.3.4)] the requirements above 200 kHz are extended from [1]. This extension is essential to guarantee compatibility with broadband xDSL systems.

Table 10: Break points of the narrow-band voltage limits. A voltage of 1 V, equals 0 dBV, and causes a power of 2,2 dBm in 600 Ω and 8,7 dBm in 135 Ω

frequency f	impedance Z	Signal Level U	Power Bandwidth B	Spectral Voltage U/ \sqrt{B}
30 Hz	Z_R	-33,7 dBV	10 Hz	-43,7 dBV/ $\sqrt{\text{Hz}}$
100 Hz	Z_R	-10,7 dBV	10 Hz	-20,7 dBV/ $\sqrt{\text{Hz}}$
200 Hz	Z_R	-6,7 dBV	10 Hz	-16,7 dBV/ $\sqrt{\text{Hz}}$
3,8 kHz	Z_R	-6,7 dBV	10 Hz	-16,7 dBV/ $\sqrt{\text{Hz}}$
3,9 kHz	Z_R	-10,7 dBV	10 Hz	-20,7 dBV/ $\sqrt{\text{Hz}}$
4,0 kHz	Z_R	-16,7 dBV	10 Hz	-26,7 dBV/ $\sqrt{\text{Hz}}$
4,3 kHz	Z_R	-44,7 dBV	10 Hz	-54,7 dBV/ $\sqrt{\text{Hz}}$
4,3 kHz	Z_R	-40 dBV	300 Hz	-65 dBV/ $\sqrt{\text{Hz}}$
5,1 kHz	Z_R	-44 dBV	300 Hz	-69 dBV/ $\sqrt{\text{Hz}}$
8,9 kHz	Z_R	-44 dBV	300 Hz	-69 dBV/ $\sqrt{\text{Hz}}$
11,0 kHz	Z_R	-58,5 dBV	300 Hz	-73,5 dBV/ $\sqrt{\text{Hz}}$
11,0 kHz	Z_R	-58,5 dBV	1 kHz	-88,5 dBV/ $\sqrt{\text{Hz}}$
200 kHz	Z_R	-58,5 dBV	1 kHz	-88,5 dBV/ $\sqrt{\text{Hz}}$
200 kHz	135 Ω	-60 dBV	1 kHz	-90 dBV/ $\sqrt{\text{Hz}}$
500 kHz	135 Ω	-90 dBV	1 kHz	-120 dBV/ $\sqrt{\text{Hz}}$
500 kHz	135 Ω	-60 dBV	1 MHz	-120 dBV/ $\sqrt{\text{Hz}}$
30 MHz	135 Ω	-60 dBV	1 MHz	-120 dBV/ $\sqrt{\text{Hz}}$

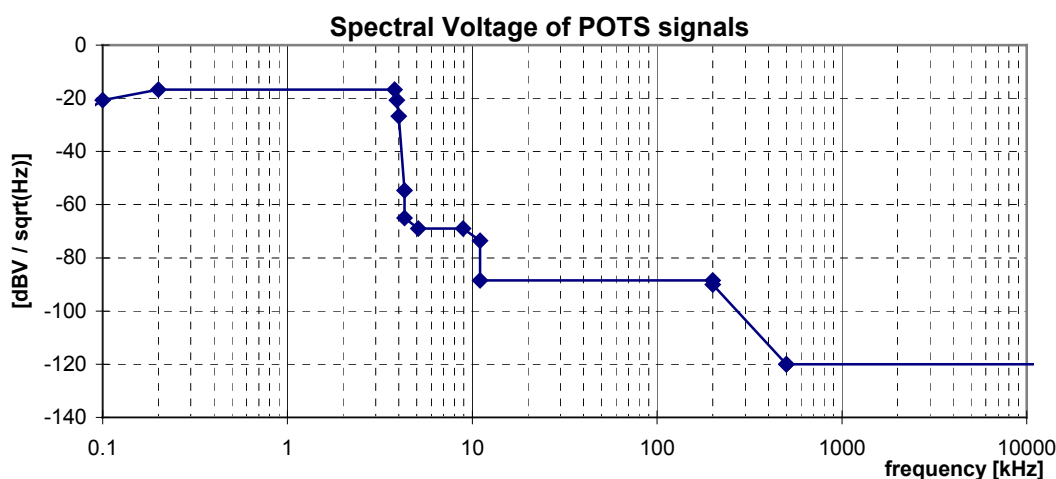

Figure 3: Spectral Voltage, for POTS signals, as specified in table 10

During tone signalling the limits given in table 10 do not apply to DTMF signals and are replaced by the following limits:

- In the range 4,3 kHz to 20 kHz, the individual level of any single frequency component shall not exceed -35,7 dBV, when terminated with Z_R .
- In the range 20 kHz to 200 kHz, the individual level of any single frequency component shall not exceed -40,7 dBV, when terminated with Z_R .
- In the range 200 kHz to 30 MHz, the individual level of any single frequency component is left for further study.

Reference: TBR 21 [1], subclause 4.7.3.4.

8.1.4 Unbalance about earth

To be compliant with this signal category, the balance of the signal that may flow through the LT-port or NT-port shall exceed minimum requirements, under the condition that the local loop wiring and its termination is well balanced. This

can be verified by a longitudinal output voltage (LOV) and a longitudinal conversion loss (LCL) measurement at the source of that signal, as specified in subclauses 13.3.2 and 13.3.3. The minimum LOV and LCL requirements hold for what can be observed at the ports of the Local Loop Wiring, when the Local Loop Wiring is replaced by an artificial impedance network described in subclauses 13.3.2 and 13.3.3.

The differential termination impedance for LOV and LCL measurements shall be chosen equally to the impedance $R_T = R_1 + R_2$, as specified in table 11.

Table 11: Values for the components for the terminating impedance for measuring the LOV and LCL

	Value	Frequency range	Tolerance
Resistance R_T	300 Ω	50 Hz – 3 800 Hz	
Resistance R_T	135/2 Ω	3 800 Hz – 30 MHz	$R_1/R_2 = 1 \pm 0,1 \%$
NOTE: TE powering by Feeding bridge according to TBR 21 [1], subclause 4.4.3.			

The observed LOV shall have an rms voltage of below the value specified in table 12, measured in a power bandwidth B , centred over any frequency in the range from f_{\min} to f_{\max} , and averaged in any one second period. Compliance with this limitation is required with a longitudinal terminating impedance having value $Z_L(\omega) = R_L + 1/(j\omega C_L)$ for all frequencies between f_{\min} to f_{\max} . Subclause 13.3.2 defines an example measurement method for longitudinal output voltage.

The observed LCL shall be higher than the lower limits given in figure 4. The LCL values of the associated break frequencies of this figure are given in table 13. Subclause 13.3.3 defines an example measurement method for longitudinal conversion loss.

Reference: TBR 21 [1], subclauses 4.4.3 and 4.7.4.1.

Reference: ETS 300 450 [4], subclause 4.4.2.

Reference: ETS 300 453 [5], subclause 4.4.2.

Reference: TS 101 270-1 [23], subclause 8.3.3.

Table 12: Values for the LOV limits

LOV	B	f_{\min}	f_{\max}	R_L	C_L
-46 dBV	1 kHz	510 Hz	10 kHz	100 Ω	150 nF

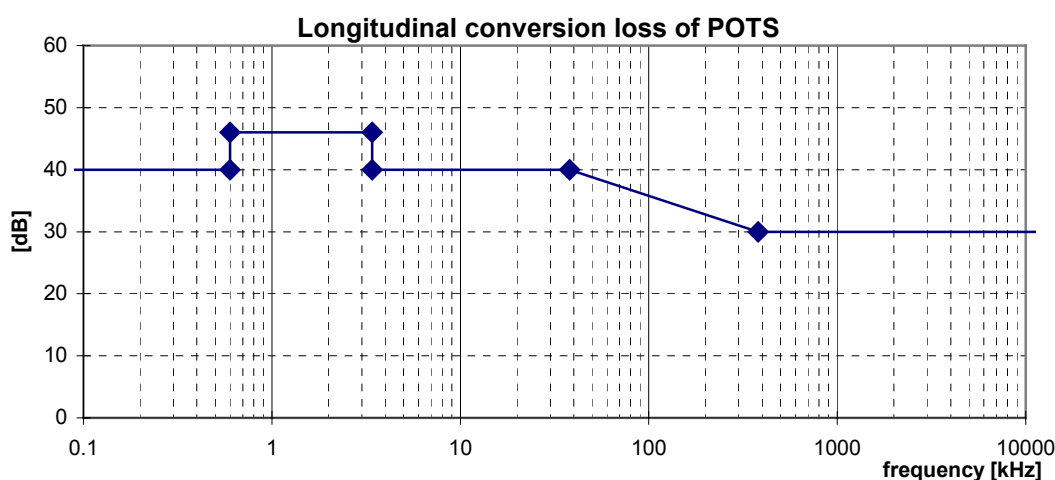

Figure 4: Minimum longitudinal conversion loss for a POTS-signal source

Table 13: Frequencies and LCL values of the breakpoints of the LCL mask in figure 4

Frequency range	Minimum value	Impedance
50 Hz to 600 Hz	40 dB	600 Ω
600 Hz to 3 400 Hz	46 dB	600 Ω
3 400 Hz to 3 800 Hz	40 dB	600 Ω
3 800 Hz to 38 kHz	40 dB	135 Ω
38 kHz to 380 kHz	40 dB to 30 dB	135 Ω
380 kHz to 30 MHz	30 dB	135 Ω

8.1.5 Feeding Power (from the LT-port)

Power feeding is no integral part of this signal category, although it is not uncommon for POTS services. To enable power feeding in combination with this signal category, refer to one of the power feeding classes summarized in clause 7.

8.1.6 Reference impedance Z_R

The reference impedance Z_R , that is used to enable the specification of various signal levels, is the European harmonized complex impedance. This harmonized complex impedance (see figure 5) equals 270 Ω in series with a parallel combination of 750 Ω and 150 nF.

Reference: TBR 21 [1], subclause A.2.1.

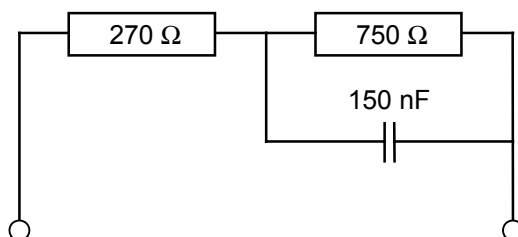
**Figure 5: Reference impedance Z_R**

8.1.7 Ringing signal

To be compliant with this signal category, the AC ringing voltage shall not exceed the maximum values in table 14. The AC ringing signal may be or may be not superimposed on the DC feeding voltage.

Reference: EG 201 188 [2], subclause 12.1.

Reference: EN 300 001 [3], subclause 1.7.2.

Table 14 Maximum ringing signal (POTS service)

	Frequency	Maximum Voltage
EG 201 188 [2]	25 \pm 2 Hz	100 V _{rms}
Country 1	50 Hz	100 V _{rms}
Country 2		

8.1.8 Metering signals

To be compliant with this signal category, 50 Hz common mode metering pulses (if added to POTS lines), shall be within the limits of table 15.

NOTE: Most access networks are using a different type of metering signals.

Reference: ETS 300 001 [3], subclause 1.7.8.

Table 15: Maximum metering signal

Frequency	Voltage	Pulse width
48 Hz to 52 Hz	maximum 100 V _{rms}	70 ms to 200 ms

9 Cluster 2 Signals (semi broad band)

This cluster summarizes signals that are generated by digital transmission equipment up to 160 kb/s, including ISDN-BRA and 64 kb/s and 128 kb/s leased lines.

9.1 "ISDN.2B1Q" Signals

This category covers signals generated by ISDN transmission equipment on a single wire-pair, based on 2B1Q line coding. This subclause is based on the ETSI reports on ISDN equipment [12].

A signal can be classified as an "ISDN.2B1Q signal" if it is compliant with all subclauses below.

9.1.1 Total signal power

To be compliant with this signal category, the mean signal power into a resistive load of 135 Ω shall not exceed a level of 13,5 dBm ($\pm 0,5$ dBm), measured within a frequency band from at least 100 Hz to 80 kHz.

Reference: TS 102 080 [12], subclause A.12.3.

9.1.2 Peak amplitude

To be compliant with this signal category, the nominal voltage peak of the largest signal pulse into a resistive load of 135 Ω shall not exceed a level of 2,5 V (± 5 %), measured within a frequency band from at least 100 Hz to 80 kHz. The definition and measurement method of peak amplitude is specified in sub clause 13.1.

Reference: TS 102 080 [12], subclause A.12.1.

9.1.3 Narrow-band signal power

To be compliant with this signal category, the narrow-band signal power (NBSP) into a resistive load impedance R , shall not exceed the limits given in table 16, at any point in the frequency range 100 Hz to 30 MHz. This table specifies the break points of these limits. Limits for intermediate frequencies can be found by drawing a straight line between the break points on a logarithmic (Hz) - linear (dB) scale. Figure 6 illustrates the NBSP in a bandwidth-normalized way.

The NBSP is the average power P of a sending signal into a load resistance R , within a **power** bandwidth B . The measurement method of the NBSP is described in subclause 13.2.

NOTE: The NBSP specification in table 16 is reconstructed from the commonly used PSD specification in [12] (similar to figure 6), and used here since it is much wider applicable. This enables a unified specification method. PSD specifications are adequate when signals are purely random in nature, but cannot cover harmonic components in a signal (would cause infinite high "PSD" levels at these harmonic frequencies). NBSP specifications cover both signal types.

The nature of the original PSD specification in [12] is in fact a NBSP specification, since the use of a 10 kHz bandwidth (above 10 kHz) and a 1 MHz bandwidth (above 300 kHz) is mandatory in [12]. The additional use of a sliding window PSD specification in [12], in order to make sure that different systems do not fill the entire allowable bandwidth with noise up to the PSD limit, illustrates the NBSP nature of the PSD specification in [12] in more detail. Mark that in [12] the lower frequency (300 kHz) has been specified, while table 16 specifies centre frequencies (starting at 300 + 500 kHz).

References: TS 102 080 [12], subclause A.12.4.

Table 16: Break points of the narrow-band power limits

Centre Frequency f	Impedance R	Signal Level P	Power bandwidth B	Spectral Power P/B	
510 Hz	135 Ω	-0 dBm	1 kHz	-30 dBm/Hz	A
10 kHz	135 Ω	-0 dBm	1 kHz	-30 dBm/Hz	
10 kHz	135 Ω	10 dBm	10 kHz	-30 dBm/Hz	
50 kHz	135 Ω	10 dBm	10 kHz	-30 dBm/Hz	
500 kHz	135 Ω	-40 dBm	10 kHz	-80 dBm/Hz	
1,4 MHz	135 Ω	-40 dBm	10 kHz	-80 dBm/Hz	
5 MHz	135 Ω	-80 dBm	10 kHz	-120 dBm/Hz	
30 MHz	135 Ω	-80 dBm	10 kHz	-120 dBm/Hz	
800 kHz	135 Ω	-30 dBm	1 MHz	-90 dBm/Hz	B
1,4 MHz	135 Ω	-30 dBm	1 MHz	-90 dBm/Hz	
3,637 MHz	135 Ω	-60 dBm	1 MHz	-120 dBm/Hz	
30 MHz	135 Ω	-60 dBm	1 MHz	-120 dBm/Hz	

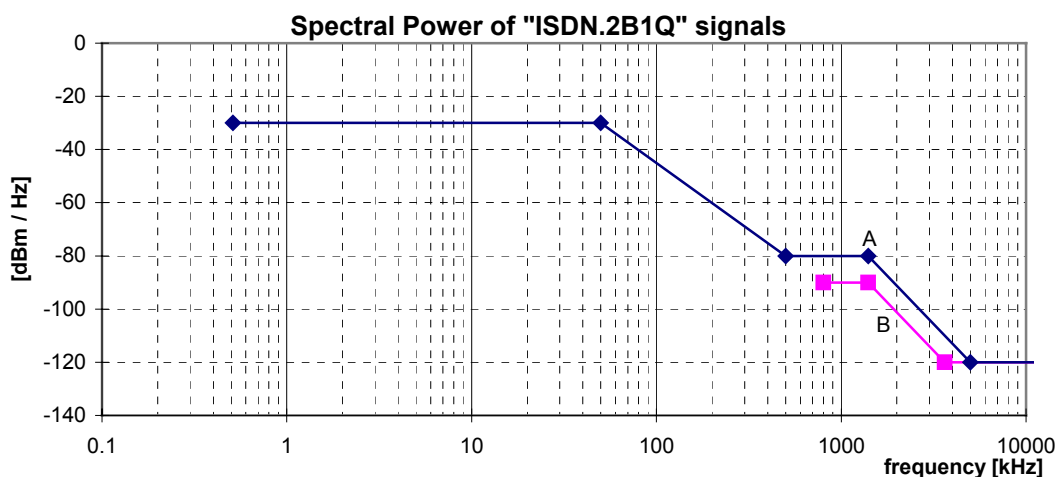

Figure 6: Spectral Power, for ISDN.2B1Q signals, as specified in table 16

9.1.4 Unbalance about earth

To be compliant with this signal category, the balance of the signal that may flow through the LT-port or NT-port shall exceed minimum requirements, under the condition that the local loop wiring and its termination is well balanced. This can be verified by a longitudinal output voltage (LOV) and a longitudinal conversion loss (LCL) measurement at the source of that signal, as specified in subclauses 13.3.2 and 13.3.3. The minimum LOV and LCL requirements hold for what can be observed at the ports of the Local Loop Wiring, when the Local Loop Wiring is replaced by an artificial impedance network described in subclauses 13.3.2 and 13.3.3.

The differential termination impedance for LOV and LCL measurements shall be chosen equally to the design impedance $R_T = 135 \Omega$ of the Signal Source under test.

The observed LOV shall have an rms voltage of below the value specified in table 17, measured in a power bandwidth **B**, centred over any frequency in the range from f_{min} to f_{max} , and averaged in any one second period. Compliance with this limitation is required with a longitudinal terminating impedance having value $Z_L(\omega) = R_L + 1/(j\omega \cdot C_L)$ for all frequencies between f_{min} to f_{max} . Subclause 13.3.2 defines an example measurement method for longitudinal output voltage.

The observed LCL shall be higher than the lower limits given in figure 7. The LCL values of the associated break frequencies of this figure are given in table 18. Subclause 13.3.3 defines an example measurement method for longitudinal conversion loss.

Reference: TS 102 080 [12], subclause A.13.3.1, extended to 30 MHz according to [23].

Reference: TS 101 270-1 [23], subclause 8.3.3.

Table 17: Values for the LOV limits

LOV	B	f_{min}	f_{max}	R_L	C_L
-46 dBV	10 kHz	5,1 kHz	225 kHz	100 Ω	150 nF

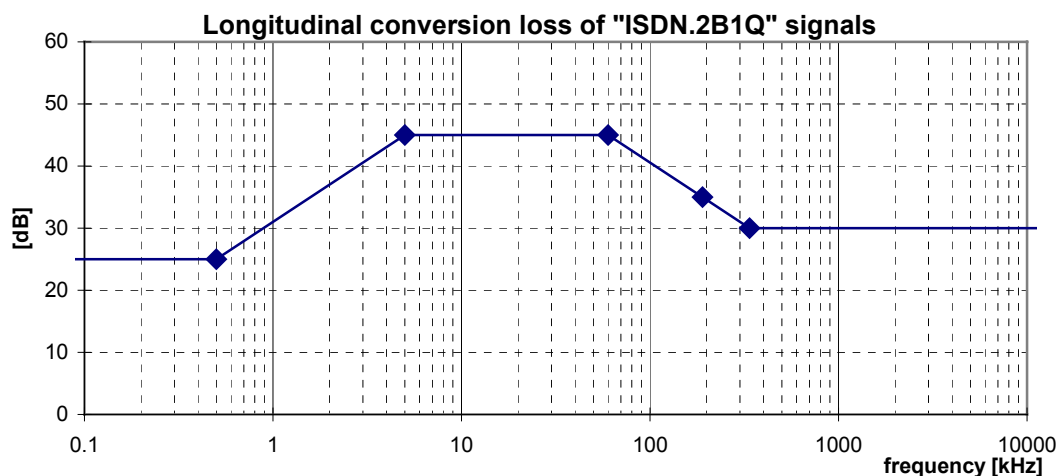

Figure 7: Minimum longitudinal conversion loss for a "ISDN.2B1Q" signal source

Table 18: Frequencies and LCL values of the breakpoints of the LCL mask in figure 7

Frequency range	LCL
< 0,5 kHz	25 dB
5 kHz	45 dB
60 kHz	45 dB
190 kHz	35 dB
337 kHz	30 dB
30 MHz	30 dB

9.1.5 Feeding Power (from the LT-port)

Power feeding is no integral part of this signal category, although it is not uncommon for ISDN.2B1Q services. To enable power feeding in combination with this signal category, refer to one of the power feeding classes summarized in clause 7.

9.2 "ISDN.MMS.43" Signals

This category covers signals generated by ISDN transmission equipment on a single wire-pair, based on MMS 43 (also known as 4B3T) line coding. This subclause is based on the ETSI reports on ISDN equipment [12].

A signal can be classified as an "ISDN.MMS.43" signal if it is compliant with all subclauses below.

9.2.1 Total signal power

To be compliant with this signal category, the mean signal power into a resistive load of $150\ \Omega$ shall not exceed a level of 13,5 dBm ($\pm 0,5$ dBm), measured within a frequency band from at least 100 Hz to 100 kHz.

No full reference. Derived from: TS 102 080 [12], subclause A.12.3.

9.2.2 Peak amplitude

To be compliant with this signal category, the nominal voltage peak of the largest signal pulse into a resistive load of $150\ \Omega$ shall not exceed a level of 2,0 V ($\pm 10\%$), measured within a frequency band from at least 100 Hz to 100 kHz. The definition and measurement method of peak amplitude is specified in sub clause 13.1.

Reference: TS 102 080 [12], subclause B.12.1.

9.2.3 Narrow-band signal power

To be compliant with this signal category, the narrow-band signal power (NBSP) into a resistive load impedance R , shall not exceed the limits given in table 19, at any point in the frequency range 100 Hz to 30 MHz. This table specifies the break points of these limits. Limits for intermediate frequencies can be found by drawing a straight line between the break points on a logarithmic (Hz) - linear (dB) scale. Figure 8 illustrates the NBSP in a bandwidth-normalized way.

The NBSP is the average power P of a sending signal into a load resistance R , within a *power* bandwidth B . The measurement method of the NBSP is described in subclause 13.2.

NOTE: The NBSP specification in table 19 is reconstructed from the commonly used PSD specification in [12] (similar to figure 8), and used here since it is much wider applicable. This enables a unified specification method. PSD specifications are adequate when signals are purely random in nature, but cannot cover harmonic components in a signal (would cause infinite high "PSD" levels at these harmonic frequencies). NBSP specifications cover both signal types.

The nature of the original PSD specification in [12] is in fact a NBSP specification, since the use of a 10 kHz bandwidth (above 10 kHz) and a 1 MHz bandwidth (above 300 kHz) is mandatory in [12]. The additional use of a sliding window PSD specification in [12], in order to make sure that different systems do not fill the entire allowable bandwidth with noise up to the PSD limit, illustrates the NBSP nature of the PSD specification in [12] in more detail.

Mark that in [12] the lower frequency (300 kHz) has been specified, while table 19 specifies centre frequencies (starting at 300 + 500 kHz).

References: TS 102 080 [12], subclause B.12.4.

Table 19: Break points of the narrow-band power limits

Centre Frequency f	Impedance R	Signal Level P	Power bandwidth B	Spectral Power P/B	
0,51 Hz	150 Ω	-0 dBm	1 kHz	-30 dBm/Hz	A
10 kHz	150 Ω	-0 dBm	1 kHz	-30 dBm/Hz	
10 kHz	150 Ω	10 dBm	10 kHz	-30 dBm/Hz	
50 kHz	150 Ω	10 dBm	10 kHz	-30 dBm/Hz	
300 kHz	150 Ω	-27 dBm	10 kHz	-67 dBm/Hz	
1 MHz	150 Ω	-27 dBm	10 kHz	-67 dBm/Hz	
5 MHz	150 Ω	-80 dBm	10 kHz	-120 dBm/Hz	B
30 MHz	150 Ω	-80 dBm	10 kHz	-120 dBm/Hz	
800 kHz	150 Ω	-17 dBm	1 MHz	-77 dBm/Hz	
1 MHz	150 Ω	-17 dBm	1 MHz	-77 dBm/Hz	
3,69 MHz	150 Ω	-60 dBm	1 MHz	-120 dBm/Hz	
30 MHz	150 Ω	-60 dBm	1 MHz	-120 dBm/Hz	

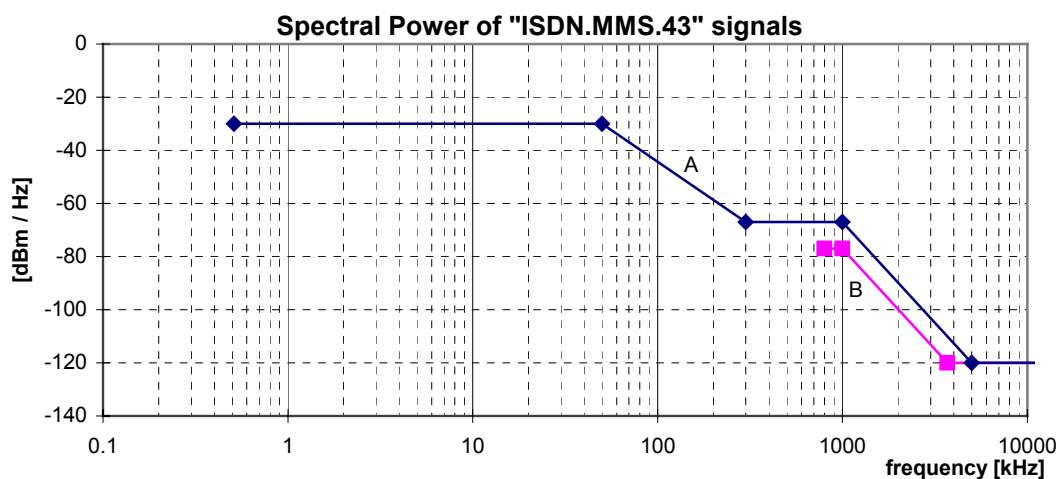

Figure 8: Spectral Power, for "ISDN.MMS.43" signals, as specified in table 19

9.2.4 Unbalance about earth

To be compliant with this signal category, the balance of the signal that may flow through the LT-port or NT-port shall exceed minimum requirements, under the condition that the local loop wiring and its termination is well balanced. This can be verified by a longitudinal output voltage (LOV) and a longitudinal conversion loss (LCL) measurement at the source of that signal, as specified in subclauses 13.3.2 and 13.3.3. The minimum LOV and LCL requirements hold for what can be observed at the ports of the Local Loop Wiring, when the Local Loop Wiring is replaced by an artificial impedance network described in subclauses 13.3.2 and 13.3.3.

The differential termination impedance for LOV and LCL measurements shall be chosen equally to the design impedance $R_T = 150 \Omega$ of the Signal Source under test.

The observed LOV shall have an rms voltage of below the value specified in table 20, measured in a power bandwidth B , centred over any frequency in the range from f_{\min} to f_{\max} , and averaged in any one second period. Compliance with this limitation is required with a longitudinal terminating impedance having value $Z_L(\omega) = R_L + 1/(j\omega C_L)$ for all frequencies between f_{\min} to f_{\max} . Subclause 13.3.2 defines an example measurement method for longitudinal output voltage.

The observed LCL shall be higher than the lower limits given in figure 9. The LCL values of the associated break frequencies of this figure are given in table 21. Subclause 13.3.3 defines an example measurement method for longitudinal conversion loss.

Reference: TS 102 080 [12], subclause B.13.3 extended to 30 MHz according to [23].

Reference: TS 101 270-1 [23], subclause 8.3.3.

Table 20: Values for the LOV limits

LOV	B	f_{\min}	f_{\max}	R_I	C_I
-46 dBV	10 kHz	5,1 kHz	245 kHz	100 Ω	150 nF

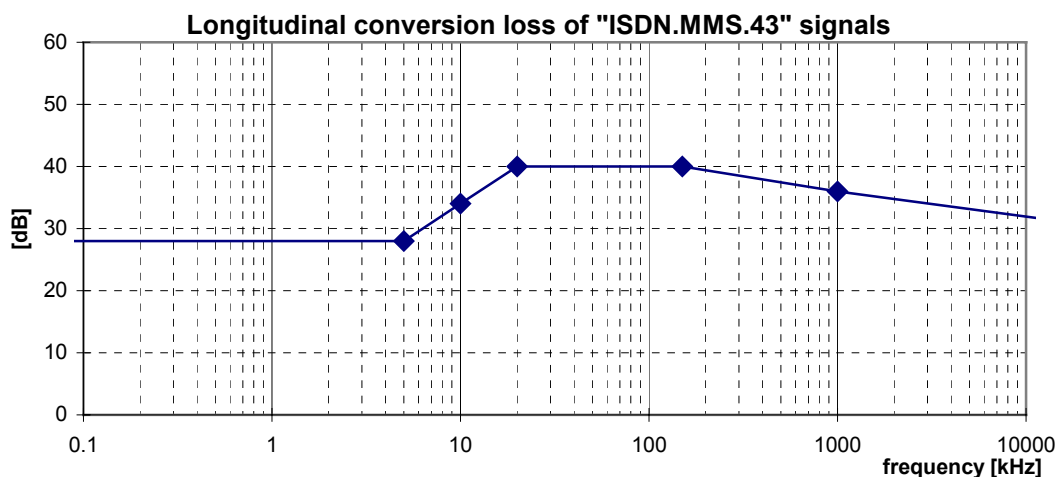

Figure 9: Minimum longitudinal conversion loss for a "ISDN.MMS43" signal source

Table 21: Frequencies and LCL values of the breakpoints of the LCL mask in figure 9

Frequency range	LCL
<5 kHz	28 dB
10 kHz	34 dB
20 kHz	40 dB
150 kHz	40 dB
1 000 kHz	36 dB
30 MHz	30 dB

9.2.5 Feeding Power (from the LT-port)

Power feeding is no integral part of this signal category, although it is not uncommon for ISDN.MMS.43 services. To enable power feeding in combination with this signal category, refer to one of the power feeding classes summarized in clause 7.

9.3 "Proprietary.SymDSL.CAP.QAM" Signals

This category covers signals, generated by Proprietary multi-rate SymDSL transmission equipment on one wire-pair.

This signal is labelled as Proprietary, since it is not covered by ETSI, ITU nor ANSI product standards.

This signal definition is linecode independent, but dedicated to signals from transmission equipment for variable bit-rate leased lines that are using CAP or QAM modulation.

A signal can be classified as a "Proprietary.SymDSL.CAP.QAM" signal if it is compliant with all subclauses below. Unless otherwise indicated, the following signal specifications apply with a resistive load impedance of 135Ω.

9.3.1 Total signal power

To be compliant with this signal category, the mean signal power into a resistive load of 135Ω shall not exceed a level of 14 dBm, measured within a frequency band from at least 100 Hz to 1 MHz.

NOTE: No ETSI deliverable does specify this parameter.

9.3.2 Peak amplitude

To be compliant with this signal category, the nominal voltage peak of the largest signal pulse into a resistive load of 135Ω shall not exceed a level of 7,5V (15V peak-peak), measured within a frequency band from at least 100 Hz to 1 MHz.

The definition and measurement method of peak amplitude is specified in sub clause 13.1.

NOTE: No ETSI deliverable does specify this parameter.

9.3.3 Narrow-band signal power (NBSP)

To be compliant with this signal category, the narrow-band signal power (NBSP) into a resistive load impedance R , shall not exceed the limits given in table 22, at any point in the frequency range 100 Hz to 30 MHz. This table specifies the break points of these limits. Limits for intermediate frequencies can be found by drawing a straight line between the break points on a logarithmic (Hz) - linear (dB) scale. Figure 10 illustrates the NBSP in a bandwidth-normalised way.

The NBSP is the average power P of a sending signal into a load resistance R , within a power bandwidth B . The measurement method of the NBSP is described in sub-clause 13.2.

NOTE: No ETSI deliverable does specify this parameter.

Table 22: Break points of the narrow-band signal power P

Centre frequency f	Impedance R	Signal Level P	Power bandwidth B	Spectral Power P/B	
510 Hz	135Ω	-0 dBm	1 kHz	-30 dBm/Hz	A
10 kHz	135Ω	-0 dBm	1 kHz	-30 dBm/Hz	
10 kHz	135Ω	10 dBm	10 kHz	-30 dBm/Hz	
50 kHz	135Ω	10 dBm	10 kHz	-30 dBm/Hz	
120 kHz	135Ω	-9 dBm	10 kHz	-49 dBm/Hz	
300 kHz	135Ω	-50 dBm	10 kHz	-90 dBm/Hz	
30 MHz	135Ω	-50 dBm	10 kHz	-90 dBm/Hz	
300 kHz	135Ω	-30 dBm	1 MHz	-90 dBm/Hz	B
460 kHz	135Ω	-50 dBm	1 MHz	-110 dBm/Hz	
30 MHz	135Ω	-50 dBm	1 MHz	-110 dBm/Hz	

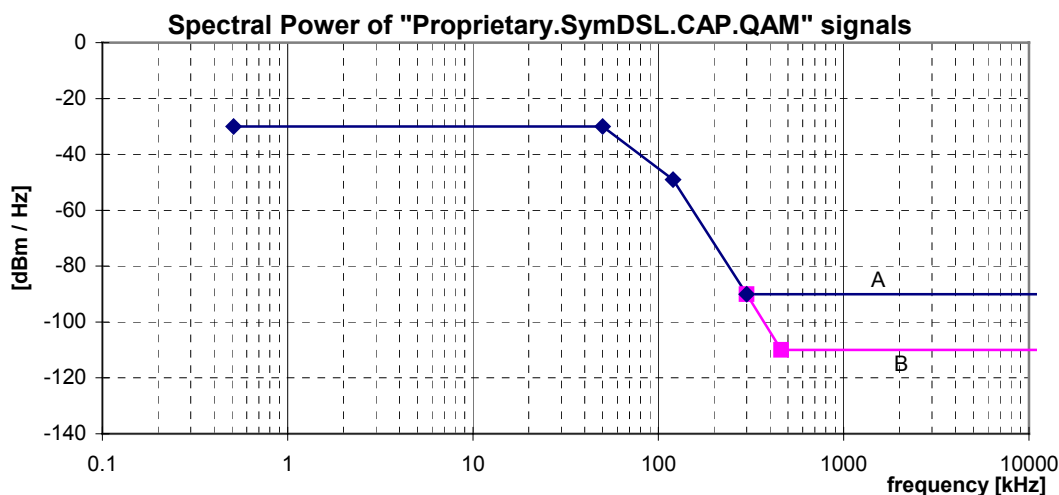

Figure 10: Spectral Power, for "Proprietary.SymDSL.CAP.QAM" signals, as specified in table 22.

9.3.4 Unbalance about earth

To be compliant with this signal category, the balance of the signal that may flow through the LT-port or NT-port shall exceed minimum requirements, under the condition that the local loop wiring and its termination is well balanced. This can be verified by a longitudinal output voltage (LOV) and a longitudinal conversion loss (LCL) measurement at the source of that signal, as specified in subclauses 13.3.2 and 13.3.3. The minimum LOV and LCL requirements hold for what can be observed at the ports of the Local Loop Wiring, when the Local Loop Wiring is replaced by an artificial impedance network described in subclauses 13.3.2 and 13.3.3.

The differential termination impedance for LOV and LCL measurements shall be chosen equally to the design impedance $R_T=135\ \Omega$ of the Signal Source under test.

The observed LOV shall have an rms voltage of below the value specified in table 23, measured in a power bandwidth B , centred over any frequency in the range from f_{\min} to f_{\max} , and averaged in any one second period. Compliance with this limitation is required with a longitudinal terminating impedance having value $Z_L(\omega)=R_L+1/(j\omega C_L)$ for all frequencies between f_{\min} to f_{\max} . Sub clause 13.3.2 defines an example measurement method for longitudinal output voltage.

The observed LCL shall be higher than the lower limits given in figure 11. The LCL values of the associated break frequencies of this figure are given in table 50. Sub clause 13.3.3 defines an example measurement method for longitudinal conversion loss.

NOTE: No ETSI deliverable does specify this parameter.

Table 23: Values for the LOV limits.

LOV	B	f_{\min}	f_{\max}	R_L	C_L
-46dBV	10 kHz	5,1 kHz	225 kHz	100 Ω	150 nF

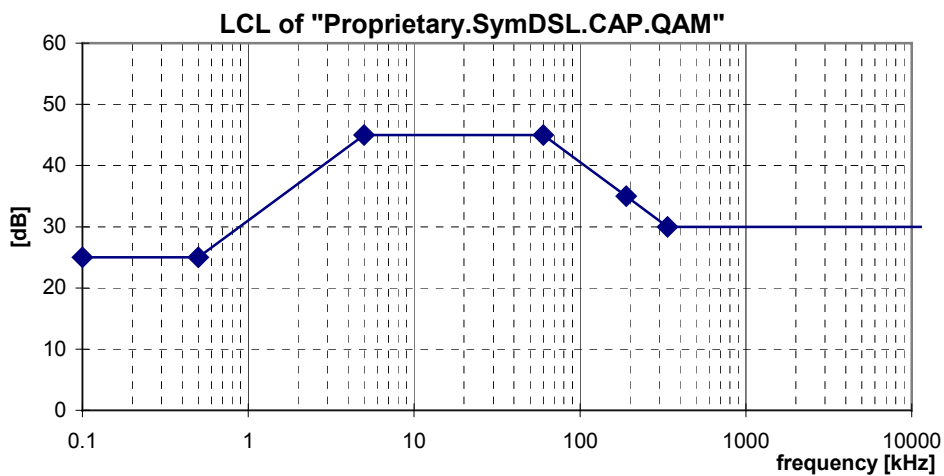

Figure 11: Minimum LCL for a "Proprietary.SymDSL.CAP.QAM" signal source.

Table 24: Frequencies and LCL values of the breakpoints of the LCL mask in figure 11.

Frequency	LCL
<0.5 kHz	25 dB
5 kHz	45 dB
60 kHz	45 dB
190 kHz	35 dB
337 kHz	30 dB
30 MHz	30 dB

10 Cluster 3 Signals (symmetrical broad band)

This cluster summarizes symmetrical signals that are generated by digital transmission equipment up to 2 Mb/s, including HDSL and SDSL. If such a system requires more than one wire-pair for carrying that bitrate, the signal description holds for each individual wire-pair.

These signals are commonly used to carry services like high quality leased lines, with symmetrical bit rates (in up- and downstream directions).

10.1 "HDSL.2B1Q/3" Signals (392 kbaud leased lines)

This category covers signals, generated by HDSL transmission equipment on three wire-pairs, based on 2B1Q line coding. This subclause is based on the ETSI reports on HDSL equipment [13]. These are essentially 392 kbaud systems (per wire-pair).

A signal (per wire-pair) can be classified as an "HDSL.2B1Q/3 signal" if it is compliant with all subclauses below. Unless otherwise indicated, the following signal specifications apply with a resistive load impedance of 135 Ω , and does not apply to the DC remote power feeding (if any).

10.1.1 Total signal power

To be compliant with this signal category, the mean signal power into a resistive load of 135 Ω shall not exceed a level of 14 dBm, measured within a frequency band from at least 100 Hz to 784 kHz.

Reference: TS 101 135 [13], subclause 5.8.4.4.

10.1.2 Peak amplitude

To be compliant with this signal category, the nominal voltage peak of the largest signal pulse into a resistive load of 135 Ω shall not exceed a level of 2,64 V ($\pm 7\%$), measured within a frequency band from at least 100 Hz to 784 kHz. The definition and measurement method of peak amplitude is specified in sub clause 13.1.

Reference: TS 101 135 [13], subclause 5.8.4.1.

10.1.3 Narrow-band signal power

To be compliant with this signal category, the narrow-band signal power (NBSP) into a resistive load impedance R , shall not exceed the limits given in table 25, at any point in the frequency range 100 Hz to 30 MHz. This table specifies the break points of these limits. Limits for intermediate frequencies can be found by drawing a straight line between the break points on a logarithmic (Hz) - linear (dB) scale. Figure 12 illustrates the NBSP in a bandwidth-normalized way.

The NBSP is the average power P of a sending signal into a load resistance R , within a *power* bandwidth B . The measurement method of the NBSP is described in subclause 13.213.2.

Reference: TS 101 135 [13], subclause 5.8.4.3. These numbers are reconstructed from PSD requirements in [13].

NOTE: The NBSP specification in table 25 is reconstructed from the commonly used PSD specification in [13] (similar to figure 12), and used here since it is much wider applicable. This enables a unified specification method. PSD specifications are adequate when signals are purely random in nature, but cannot cover harmonic components in a signal (would cause infinite high "PSD" levels at these harmonic frequencies). NBSP specifications cover both signal types.

Table 25: Break points of the narrow-band power limits. These limits are frequency independent between 100 Hz to 196 kHz, and decrease with 24 dB/octave (80 dB/decade) above 196 kHz

Centre Frequency f	Impedance R	Signal Level P	Power bandwidth B	Spectral Power P/B
0,51 kHz	135 Ω	-7 dBm	1 kHz	-37 dBm/Hz
10 kHz	135 Ω	-7 dBm	1 kHz	-37 dBm/Hz
10 kHz	135 Ω	3 dBm	10 kHz	-37 dBm/Hz
196 kHz	135 Ω	3 dBm	10 kHz	-37 dBm/Hz
1,96 MHz	135 Ω	-77 dBm	10 kHz	-117 dBm/Hz
1,96 MHz	135 Ω	-57 dBm	1 MHz	-117 dBm/Hz
30 MHz	135 Ω	-57 dBm	1 MHz	-117 dBm/Hz

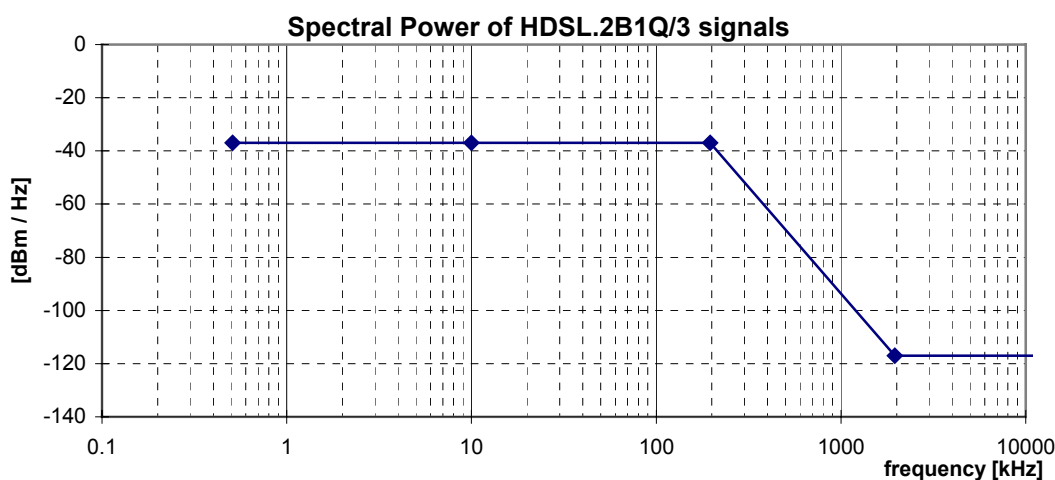

Figure 12: Spectral Power, for HDSL.2B1Q/3 signals, as specified in table 25

10.1.4 Unbalance about earth

To be compliant with this signal category, the balance of the signal that may flow through the LT-port or NT-port shall exceed minimum requirements, under the condition that the local loop wiring and its termination is well balanced. This can be verified by a longitudinal output voltage (LOV) and a longitudinal conversion loss (LCL) measurement at the source of that signal, as specified in subclauses 13.3.2 and 13.3.3. The minimum LOV and LCL requirements hold for what can be observed at the ports of the Local Loop Wiring, when the Local Loop Wiring is replaced by an artificial impedance network described in subclauses 13.3.2 and 13.3.3.

The differential termination impedance for LOV and LCL measurements shall be chosen equally to the design impedance $R_T = 135 \Omega$ of the Signal Source under test.

The observed LOV shall have an rms voltage of below the value specified in table 26, measured in a power bandwidth B , centred over any frequency in the range from f_{\min} to f_{\max} , and averaged in any one second period. Compliance with this limitation is required with a longitudinal terminating impedance having value $Z_L(\omega) = R_L + 1/(j\omega C_L)$ for all frequencies between f_{\min} to f_{\max} . Subclause 13.3.2 defines an example measurement method for longitudinal output voltage.

The observed LCL shall be higher than the lower limits given in figure 13. The LCL values of the associated break frequencies of this figure are given in table 27. Subclause 13.3.3 defines an example measurement method for longitudinal conversion loss.

Reference: TS 101 135 [13], subclause 5.8.5.1 extended to 30 MHz according to [23].

Reference: TS 101 270-1 [23], subclause 8.3.3.

Table 26: Values for the LOV limits

LOV	B	f_{min}	f_{max}	R_l	C_l
-46 dBV	10 kHz	5,1 kHz	410 kHz	100 Ω	150 nF

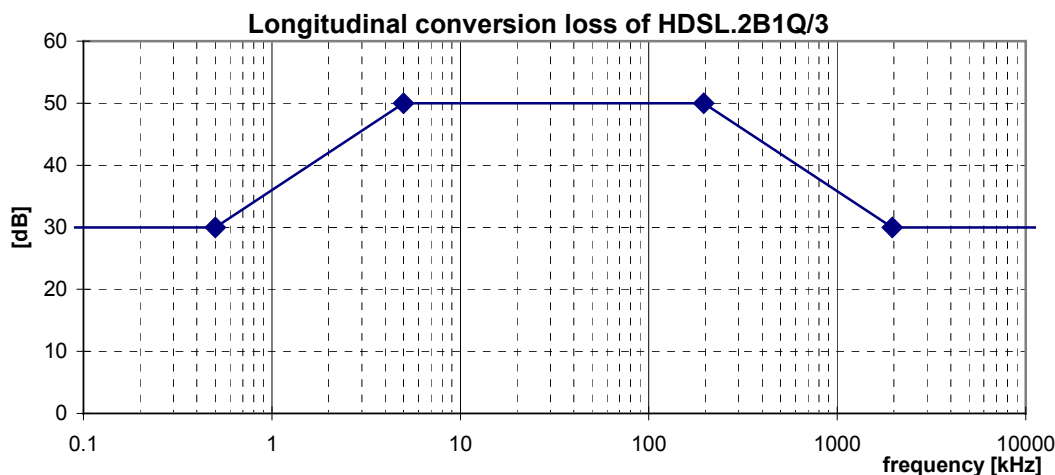

Figure 13: Minimum longitudinal conversion loss for a HDSL.2B1Q/3 signal source (392 kbaud/wirepair)

Table 27: Frequencies and LCL values of the breakpoints of the LCL mask in figure 13

Frequency	LCL
< 0,5 kHz	30 dB
5 kHz	50 dB
196 kHz	50 dB
1 960 kHz	30 dB
30 000 kHz	30 dB

10.1.5 Feeding Power (from the LT-port)

Power feeding is no integral part of this signal category, although it is not uncommon for HDSL services. To enable power feeding in combination with this signal category, refer to one of the power feeding classes summarized in clause 7.

10.2 "HDSL.2B1Q/2" Signals (584 kbaud leased lines)

This category covers signals, generated by HDSL transmission equipment on two wire-pairs, based on 2B1Q line coding. This subclause is based on the ETSI reports on HDSL equipment [13]. These are essentially 584 kbaud systems (per wire-pair).

A signal (per wire-pair) can be classified as an "HDSL.2B1Q/2 signal" if it is compliant with all subclauses below. Unless otherwise indicated, the following signal specifications apply with a resistive load impedance of 135 Ω , and does not apply to the DC remote power feeding (if any).

10.2.1 Total signal power

To be compliant with this signal category, the mean signal power into a resistive load of 135 Ω shall not exceed a level of 14 dBm, measured within a frequency band from at least 100 Hz to 1 168 kHz.

Reference: TS 101 135 [13], subclause 5.8.4.4.

10.2.2 Peak amplitude

To be compliant with this signal category, the nominal voltage peak of the largest signal pulse into a resistive load of 135 Ω shall not exceed a level of 2,64 V ($\pm 7\%$), measured within a frequency band from at least 100 Hz to 1 168 kHz. The definition and measurement method of peak amplitude is specified in sub clause 13.1.

Reference: TS 101 135 [13], subclause 5.8.4.1.

10.2.3 Narrow-band signal power

To be compliant with this signal category, the narrow-band signal power (NBSP) into a resistive load impedance R , shall not exceed the limits given in table 28, at any point in the frequency range 100 Hz to 30 MHz. This table specifies the break points of these limits. Limits for intermediate frequencies can be found by drawing a straight line between the break points on a logarithmic (Hz) - linear (dB) scale. Figure 14 illustrates the NBSP in a bandwidth-normalized way.

The NBSP is the average power P of a sending signal into a load resistance R , within a *power* bandwidth B . The measurement method of the NBSP is described in subclause 13.213.2.

Reference: TS 101 135 [13], subclause 5.8.4.3. These numbers are reconstructed from PSD requirements in [13].

NOTE: The NBSP specification in table 28 is reconstructed from the commonly used PSD specification in [13] (similar to figure 14), and used here since it is much wider applicable. This enables a unified specification method. PSD specifications are adequate when signals are purely random in nature, but cannot cover harmonic components in a signal (would cause infinite high "PSD" levels at these harmonic frequencies). NBSP specifications cover both signal types.

Table 28: Break points of the narrow-band power limits. These limits are frequency independent between 100 Hz to 292 kHz, and decrease with 24 dB/octave (80 dB/decade) above 292 kHz

Centre frequency f	Impedance R	Signal Level P	Power bandwidth B	Spectral Power P/B
0,51 kHz	135 Ω	-9 dBm	1 kHz	-39 dBm/Hz
10 kHz	135 Ω	-9 dBm	1 kHz	-39 dBm/Hz
10 kHz	135 Ω	1 dBm	10 kHz	-39 dBm/Hz
292 kHz	135 Ω	1 dBm	10 kHz	-39 dBm/Hz
2,92 MHz	135 Ω	-79 dBm	10 kHz	-119 dBm/Hz
2,92 MHz	135 Ω	-59 dBm	1 MHz	-119 dBm/Hz
30 MHz	135 Ω	-59 dBm	1 MHz	-119 dBm/Hz

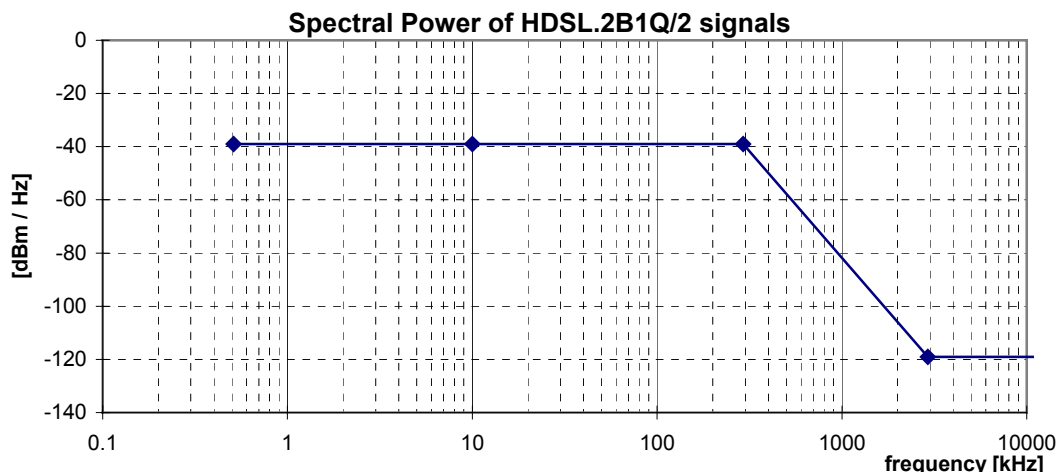

Figure 14: Spectral Power, for HDSL.2B1Q/2 signals, as specified in table 28

10.2.4 Unbalance about earth

To be compliant with this signal category, the balance of the signal that may flow through the LT-port or NT-port shall exceed minimum requirements, under the condition that the local loop wiring and its termination is well balanced. This can be verified by a longitudinal output voltage (LOV) and a longitudinal conversion loss (LCL) measurement at the source of that signal, as specified in subclauses 13.3.2 and 13.3.3. The minimum LOV and LCL requirements hold for what can be observed at the ports of the Local Loop Wiring, when the Local Loop Wiring is replaced by an artificial impedance network described in subclauses 13.3.2 and 13.3.3.

The differential termination impedance for LOV and LCL measurements shall be chosen equally to the design impedance $R_T = 135 \Omega$ of the Signal Source under test.

The observed LOV shall have an rms voltage of below the value specified in table 29, measured in a power bandwidth **B**, centred over any frequency in the range from f_{\min} to f_{\max} , and averaged in any one second period. Compliance with this limitation is required with a longitudinal terminating impedance having value $Z_L(\omega) = R_L + 1/(j\omega C_L)$ for all frequencies between f_{\min} to f_{\max} . Subclause 12.2 defines an example measurement method for longitudinal output voltage.

The observed LCL shall be higher than the lower limits given in figure 15. The LCL values of the associated break frequencies of this figure are given in table 30. Subclause 13.3.3 defines an example measurement method for longitudinal conversion loss.

Reference: TS 101 135 [13], subclause 5.8.5.1 extended to 30 MHz according to [23].

Reference: TS 101 270-1 [23], subclause 8.3.3.

Table 29: Values for the LOV limits

LOV	B	f_{\min}	f_{\max}	R_L	C_L
-46 dBV	10 kHz	5,1 kHz	575 kHz	100 Ω	150 nF

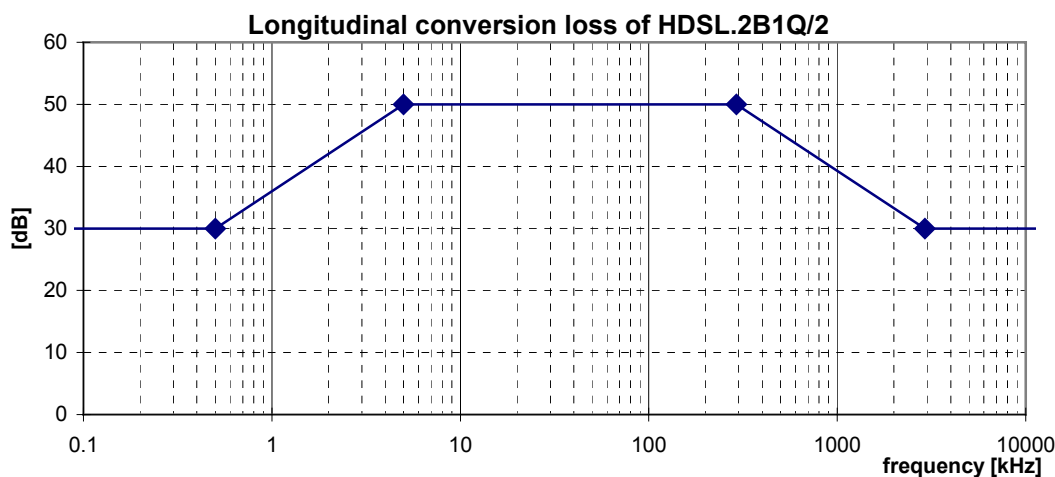

Figure 15: Minimum longitudinal conversion loss for a HDSL.2B1Q/2 signal source (584 kbaud/wirepair)

Table 30: Frequencies and LCL values of the breakpoints of the LCL mask in figure 15

Frequency	LCL
< 0,5 kHz	30 dB
5 kHz	50 dB
292 kHz	50 dB
2 920 kHz	30 dB
30 000 kHz	30 dB

10.2.5 Feeding Power (from the LT-port)

Power feeding is no integral part of this signal category, although it is not uncommon for HDSL services. To enable power feeding in combination with this signal category, refer to one of the power feeding classes summarized in clause 7.

10.3 "HDSL.2B1Q/1" Signals (1160 kbaud leased lines)

This category covers signals, generated by HDSL transmission equipment on a single wire-pair, based on 2B1Q line coding. This subclause is based on the ETSI reports on HDSL equipment [13].

A signal (per wire-pair) can be classified as an "HDSL.2B1Q/1 signal" if it is compliant with all subclauses below. Unless otherwise indicated, the following signal specifications apply with a resistive load impedance of 135 Ω , and does not apply to the DC remote power feeding (if any).

10.3.1 Total signal power

To be compliant with this signal category, the mean signal power into a resistive load of 135 Ω shall not exceed a level of 14 dBm, measured within a frequency band from at least 100 Hz to 2 320 kHz.

Reference: TS 101 135 [13], subclause 5.8.4.4.

10.3.2 Peak amplitude

To be compliant with this signal category, the nominal voltage peak of the largest signal pulse into a resistive load of $135\ \Omega$ shall not exceed a level of $2,50\ \text{V}$ ($\pm 7\%$), measured within a frequency band from at least $100\ \text{Hz}$ to $2320\ \text{kHz}$. The definition and measurement method of peak amplitude is specified in sub clause 13.1.

Reference: TS 101 135 [13], subclause 5.8.4.1.

10.3.3 Narrow-band signal power

To be compliant with this signal category, the narrow-band signal power (NBSP) into a resistive load impedance R , shall not exceed the limits given in table 31, at any point in the frequency range $100\ \text{Hz}$ to $30\ \text{MHz}$. This table specifies the break points of these limits. Limits for intermediate frequencies can be found by drawing a straight line between the break points on a logarithmic (Hz) - linear (dB) scale. Figure 16 illustrates the NBSP in a bandwidth-normalized way.

The NBSP is the average power P of a sending signal into a load resistance R , within a *power* bandwidth B . The measurement method of the NBSP is described in subclause 13.2.

NOTE: The NBSP specification in table 31 is reconstructed from the commonly used PSD specification in [13] (similar to figure 16), and used here since it is much wider applicable. This enables a unified specification method. PSD specifications are adequate when signals are purely random in nature, but cannot cover harmonic components in a signal (would cause infinite high "PSD" levels at these harmonic frequencies). NBSP specifications cover both signal types.

Reference: TS 101 135 [13], subclause 5.8.4.3. These numbers are reconstructed from PSD requirements in [13].

Table 31: Break points of the narrow-band power limits. These limits are frequency independent between $100\ \text{Hz}$ to $485\ \text{kHz}$, and decrease with $24\ \text{dB/octave}$ ($80\ \text{dB/decade}$) above $485\ \text{kHz}$

Centre frequency f	Impedance R	Signal Level P	Power bandwidth B	Spectral Power P/B
0,51 kHz	135 Ω	-11,5 dBm	1 kHz	-41,5 dBm/Hz
10 kHz	135 Ω	-11,5 dBm	1 kHz	-41,5 dBm/Hz
10 kHz	135 Ω	-1,5 dBm	10 kHz	-41,5 dBm/Hz
485 kHz	135 Ω	-1,5 dBm	10 kHz	-41,5 dBm/Hz
4,850 MHz	135 Ω	-81,5 dBm	10 kHz	-121,5 dBm/Hz
4,850 MHz	135 Ω	-61,5 dBm	1 MHz	-121,5 dBm/Hz
30 MHz	135 Ω	-61,5 dBm	1 MHz	-121,5 dBm/Hz

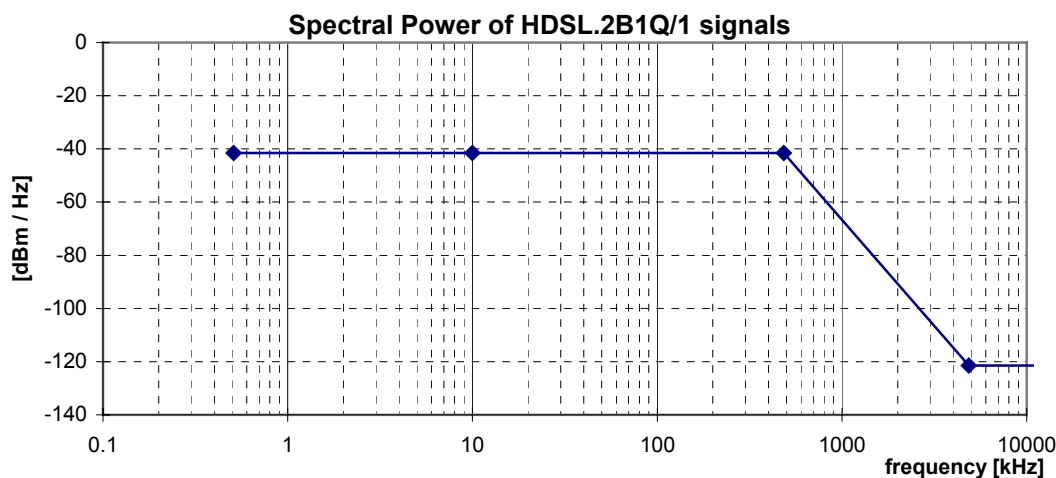

Figure 16: Spectral Power, for HDSL.2B1Q/1 signals, as specified in table 31

10.3.4 Unbalance about earth

To be compliant with this signal category, the balance of the signal that may flow through the LT-port or NT-port shall exceed minimum requirements, under the condition that the local loop wiring and its termination is well balanced. This can be verified by a longitudinal output voltage (LOV) and a longitudinal conversion loss (LCL) measurement at the source of that signal, as specified in subclauses 13.3.2 and 13.3.3. The minimum LOV and LCL requirements hold for what can be observed at the ports of the Local Loop Wiring, when the Local Loop Wiring is replaced by an artificial impedance network described in subclauses 13.3.2 and 13.3.3.

The differential termination impedance for LOV and LCL measurements shall be chosen equally to the design impedance $R_T = 135 \Omega$ of the Signal Source under test.

The observed LOV shall have an rms voltage of below the value specified in table 32, measured in a power bandwidth B , centred over any frequency in the range from f_{\min} to f_{\max} , and averaged in any one second period. Compliance with this limitation is required with a longitudinal terminating impedance having value $Z_L(\omega) = R_L + 1/(j\omega C_L)$ for all frequencies between f_{\min} to f_{\max} . Subclause 13.3.2 defines an example measurement method for longitudinal output voltage.

The observed LCL shall be higher than the lower limits given in figure 17. The LCL values of the associated break frequencies of this figure are given in table 33. Subclause 13.3.3 defines an example measurement method for longitudinal conversion loss.

Reference: TS 101 135 [13], subclause 5.8.5.1, extended to 30 MHz according to [23].

Reference: TS 101 270-1 [23], subclause 8.3.3.

Table 32: Values for the LOV limits

LOV	B	f_{\min}	f_{\max}	R_L	C_L
-46 dBV	10 kHz	5,1 kHz	890 kHz	100 Ω	150 nF

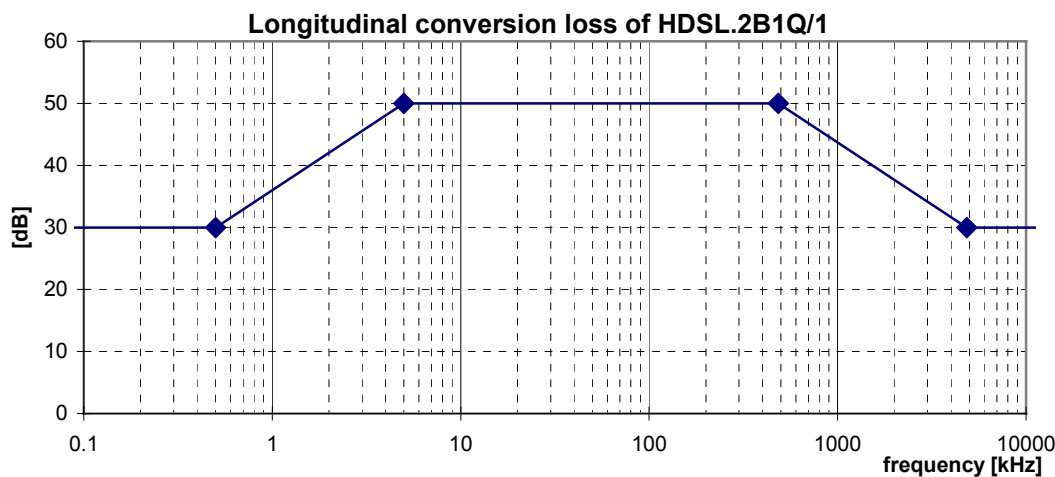

Figure 17: Minimum longitudinal conversion loss for a HDSL.2B1Q/1 signal source

Table 33: Frequencies and LCL values of the breakpoints of the LCL mask in figure 17

Frequency	LCL
<0,5 kHz	30 dB
5 kHz	50 dB
485 kHz	50 dB
4 850 kHz	30 dB
30 000 kHz	30 dB

10.3.5 Feeding Power (from the LT-port)

Power feeding is no integral part of this signal category, although it is not uncommon for HDSL services. To enable power feeding in combination with this signal category, refer to one of the power feeding classes summarized in clause 7.

10.4 "HDSL.CAP/2" Signals

This category covers signals, generated by HDSL transmission equipment on two wire-pairs, based on CAP modulation. This subclause is based on the ETSI reports on HDSL equipment [13].

A signal (per wire-pair) can be classified as an "HDSL.CAP/2 signal" if it is compliant with all subclauses below. Unless otherwise indicated, the following signal specifications apply with a resistive load impedance of 135 Ω , and does not apply to the DC remote power feeding (if any).

10.4.1 Total signal power

To be compliant with this signal category, the mean signal power into a resistive load of 135 Ω shall not exceed a level of 14 dBm, measured within a frequency band from at least 100 Hz to 1 MHz.

Reference: TS 101 135 [13], subclause B.5.8.4.1.

10.4.2 Peak amplitude

To be compliant with this signal category, the nominal voltage peak of the largest signal pulse into a resistive load of 135 Ω shall not exceed a level of 6,5 V (13 V peak-peak), measured within a frequency band from at least 100 Hz to 1 MHz. The definition and measurement method of peak amplitude is specified in sub clause 13.1.

NOTE: No ETSI deliverable does specify this parameter.

10.4.3 Narrow-band signal power (NBSP)

To be compliant with this signal category, the narrow-band signal power (NBSP) into a resistive load impedance R , shall not exceed the limits given in table 34, at any point in the frequency range 100 Hz to 30 MHz. This table specifies the break points of these limits. Limits for intermediate frequencies can be found by drawing a straight line between the break points on a logarithmic (Hz) - linear (dB) scale. Figure 18 illustrates the NBSP in a bandwidth-normalized way.

The NBSP is the average power P of a sending signal into a load resistance R , within a *power* bandwidth B . The measurement method of the NBSP is described in subclause 13.2.

NOTE: The NBSP specification in table 34 is reconstructed from the commonly used PSD specification in [13] (similar to figure 18), and used here since it is much wider applicable. This enables a unified specification method. PSD specifications are adequate when signals are purely random in nature, but cannot cover harmonic components in a signal (would cause infinite high "PSD" levels at these harmonic frequencies). NBSP specifications cover both signal types. The NBSP specification of this signal category has been split into two overlapping limits. Both upper limits shall be met simultaneously. The 10 kHz bandwidth values represent the "maximum PSD values" from [13], while the 100 kHz bandwidth values represent the "nominal PSD values". The 100 kHz bandwidth specification has been added here to smooth spectral ripple (" $\pm 1,5$ dB") from the "maximum PSD" into the "nominal PSD".

Reference: TS 101 135 [13], subclause B.5.8.4.2, reconstructed from the PSD requirements in [13].

Table 34: Frequencies of the break points and the corresponding peak and average values of the narrow-band signal power

Centre frequency f	Impedance R	Signal Level P	Power bandwidth B	Spectral Power P/B	
0,51 kHz	135 Ω	-25,5 dBm	1 kHz	-55,5 dBm/Hz	A
3,98 kHz	135 Ω	-25,5 dBm	1 kHz	-55,5 dBm/Hz	
3,98 kHz	135 Ω	-15,5 dBm	10 kHz	-55,5 dBm/Hz	
21,50 kHz	135 Ω	-1,5 dBm	10 kHz	-41,5 dBm/Hz	
39,02 kHz	135 Ω	+1,5 dBm	10 kHz	-38,5 dBm/Hz	
237,58 kHz	135 Ω	+1,5 dBm	10 kHz	-38,5 dBm/Hz	
255,10 kHz	135 Ω	-1,5 dBm	10 kHz	-41,5 dBm/Hz	
272,62 kHz	135 Ω	-17 dBm	10 kHz	-57 dBm/Hz	
297,00 kHz	135 Ω	-30 dBm	10 kHz	-70 dBm/Hz	
1,188 MHz	135 Ω	-80 dBm	10 kHz	-120 dBm/Hz	
1,188 MHz	135 Ω	-60 dBm	1 MHz	-120 dBm/Hz	B
30 MHz	135 Ω	-60 dBm	1 MHz	-120 dBm/Hz	
30 kHz	135 Ω	+10 dBm	100 kHz	-40 dBm/Hz	B
250 kHz	135 Ω	+10 dBm	100 kHz	-40 dBm/Hz	

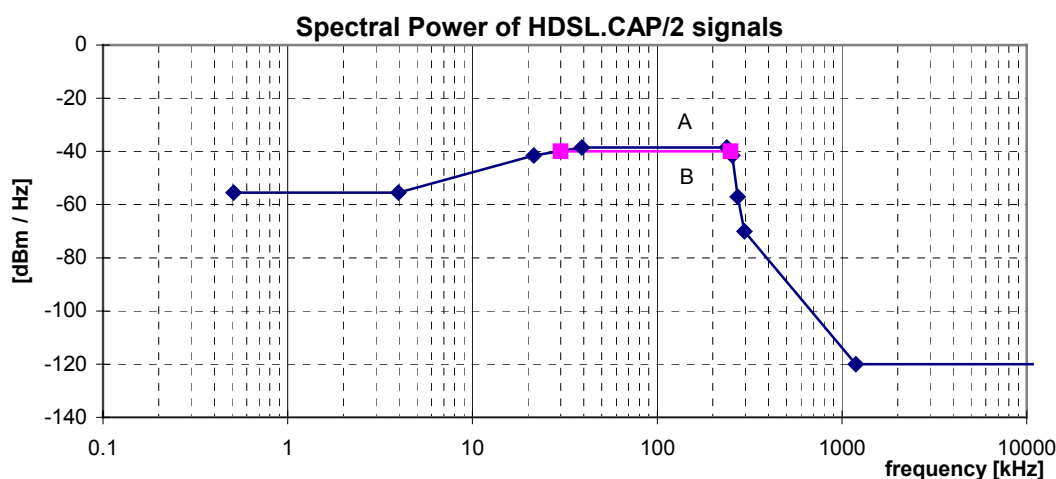

Figure 18: Spectral Power, for HDSL.CAP/2 signals, as specified in table 34

10.4.4 Unbalance about earth

To be compliant with this signal category, the balance of the signal that may flow through the LT-port or NT-port shall exceed minimum requirements, under the condition that the local loop wiring and its termination is well balanced. This can be verified by a longitudinal output voltage (LOV) and a longitudinal conversion loss (LCL) measurement at the source of that signal, as specified in subclauses 13.3.2 and 13.3.3. The minimum LOV and LCL requirements hold for what can be observed at the ports of the Local Loop Wiring, when the Local Loop Wiring is replaced by an artificial impedance network described in subclauses 13.3.2 and 13.3.3.

The differential termination impedance for LOV and LCL measurements shall be chosen equally to the design impedance $R_T = 135 \Omega$ of the Signal Source under test.

The observed LOV shall have an rms voltage of below the value specified in table 35, measured in a power bandwidth B , centred over any frequency in the range from f_{\min} to f_{\max} , and averaged in any one second period. Compliance with this limitation is required with a longitudinal terminating impedance having value $Z_L(\omega) = R_L + 1/(j\omega C_L)$ for all frequencies between f_{\min} to f_{\max} . Subclause 13.3.2 defines an example measurement method for longitudinal output voltage.

The observed LCL shall be higher than the lower limits given in figure 19. The LCL values of the associated break frequencies of this figure are given in table 36. Subclause 13.3.3 defines an example measurement method for longitudinal conversion loss.

Reference: TS 101 135 [13], subclause B.5.8.5.1, extended to 30 MHz according to [23].

Reference: TS 101 270-1 [23], subclause 8.3.3.

Table 35: Values for the LOV limits

LOV	B	f_{\min}	f_{\max}	R_L	C_L
-46 dBV	10 kHz	5,1 kHz	285 kHz	100 Ω	150 nF

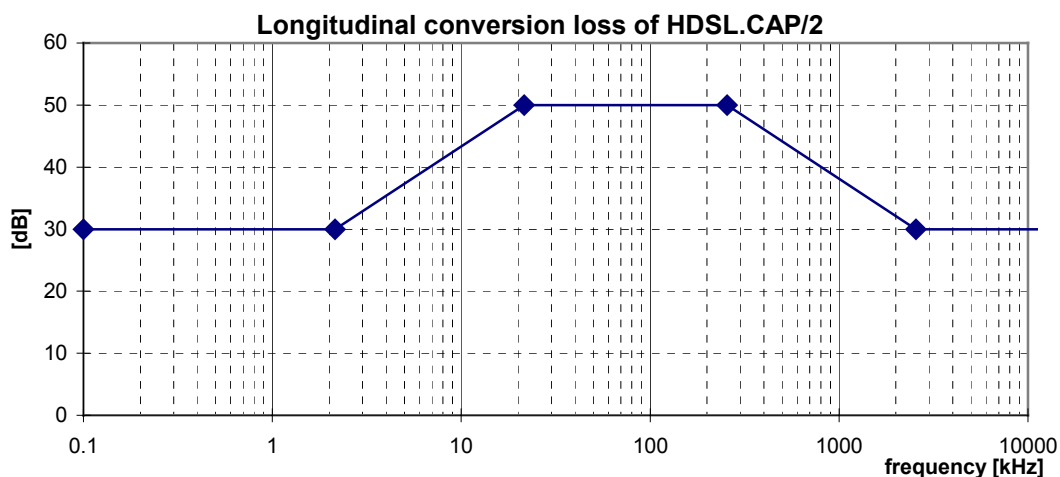

Figure 19: Minimum longitudinal conversion loss

Table 36: Frequencies and LCL values of the breakpoints of the LCL mask in figure 19

Frequency	LCL
< 2,15 kHz	30 dB
21,5 kHz	50 dB
255 kHz	50 dB
2 550 kHz	30 dB
30 000 kHz	30 dB

10.4.5 Feeding Power (from the LT-port)

Power feeding is no integral part of this signal category, although it is not uncommon for HDSL services. To enable power feeding in combination with this signal category, refer to one of the power feeding classes summarized in clause 7.

10.5 "SDSL::Fn" Signals

This category covers signals, generated by multi-rate SDSL transmission equipment on one or two wire pairs. This sub clause is based on ETSI SDSL standards [14, 15] and on ITU draft Recommendation G.991.2 [16]. The line code modulation used in these draft standards is Ungerboeck Coded Pulse Amplitude Modulation (UC-PAM), also known as Trellis Coded PAM (TC-PAM).

The SDSL standards specify both symmetric and asymmetric PSD masks. This signal description is dedicated to the symmetric variant. For the symmetric PSD masks the naming convention is "SDSL::Fn" where the phrase "Fn" is a placeholder for a number that is used as parameter F_N in the signal definition. Replacing "Fn" in the signal name by a value, changes the generic signal description into a specific description, since its value is required in the sub clauses below. It is referred to as the *Principal frequency* of the signal.

The Principal frequency F_N is indicative for the symbol rate [kbaud] that can be transported within these signal limits. A signal with a higher Principal Frequency occupies a wider spectrum. A signal with a lower Principal Frequency has a higher inband PSD.

Table 37 gives several examples on how to use the naming convention for specifying the actual parameter value F_n . It also illustrates some (informative) bit rates that can be transported within these signal limits, when using the associated (informative) modulation parameters. These are examples only, other system implementations may use the same signal limits in a different way.

Table 37: Example on how the naming convention relates to the actual parameter value F_N that is used in the sub clauses below to specify the signal limits of this signal category. The actual bit rates and modulation parameters are implementation dependent, and informative only.

Signal category	F_N [kHz]	Symbol Rate [kbaud]	Bit/symbol	Line Bit Rate [kb/s]
SDSL::67	66.67	66.67	3	200
SDSL::131	130.67	130.67	3	392
SDSL::174	173.33	173.33	3	520
SDSL::259	258.67	258.67	3	776
SDSL::344	344	344	3	1032
SDSL::430	429.33	429.33	3	1288
SDSL::515	514.67	514.67	3	1544
SDSL::686	685.33	685.33	3	2056
SDSL::771	770.67	770.67	3	2312

10.5.1 Total Signal Power

To be compliant with this signal category, the mean signal power into a resistive load of 135Ω shall not exceed a level of P_{\max} , measured within a frequency band from at least 100 Hz to $2 \times F_N$. P_{\max} has the following values for the different SDSL signals:

- 14.00 dBm for "SDSL::Fn" signals, when $F_n < 685\text{kHz}$
- 15.00 dBm for "SDSL::Fn" signals, when $F_n \geq 685\text{kHz}$

Reference: ETSI TS 101 524-2 [15], clause 4.4.1 & 4.4.2

Reference: ITU G.991.2 (draft) [16], clause B.4.1 & B.4.2

10.5.2 Peak amplitude

To be compliant with this signal category, the nominal voltage peak of the largest signal pulse into a resistive load of 135Ω shall not exceed a level of $V_{\text{peak}} (\pm 7\%)$, measured within a frequency band from at least 100 Hz to $F_N \times 2$. V_{peak} has the following values for the different SDSL signals:

- 12 V for "SDSL::Fn" signals, when $F_N < 685\text{kHz}$
- 12V for "SDSL::Fn" signals, when $F_N \geq 685\text{kHz}$

The definition and measurement method of peak amplitude is specified in sub clause 13.1.

NOTE: No ETSI deliverable does specify this parameter.

10.5.3 Narrow-band signal power (NBSP)

To be compliant with this signal category, the narrow-band signal power (NBSP) into a resistive load impedance R , shall not exceed the limits given in the tables in the following subsections, at any point in the frequency range 100 Hz to 30 MHz. Limits for intermediate frequencies can be found by drawing a straight line between the break points on a logarithmic (Hz) - linear (dB) scale. The NBSP is the average power P of a sending signal into a load resistance R , within a power bandwidth B . The measurement method of the NBSP is described in sub-clause 13.2.

Table 38 describes the break points of these limits for the symmetric PSD masks for all Principal frequencies between 67 and 771 kHz. Figure 20 illustrates the NBSP in a bandwidth-normalised way.

Reference: ETSI TS 101 524-2 [15], clause 4.4.1

Reference: ITU G.991.2 (draft) [16], clause B.4.1

Table 38: Break points of the narrow-band signal power P , as a function of the Principal frequency F_N of the signal category.

frequency f	Impedance R	Signal Level P [dBm]	Noise Bandwidth B	Spectral Power P/B [dBm/Hz]
0,1 kHz	135Ω	$P_0 + 1,4 + 20$	100 Hz	$P_0 + 1,4$
1 kHz	135Ω	$P_0 + 1,4 + 20$	100 Hz	$P_0 + 1,4$
1 kHz	135Ω	$P_0 + 1,4 + 30$	1 kHz	$P_0 + 1,4$
10 kHz	135Ω	$P_0 + 1,4 + 30$	1 kHz	$P_0 + 1,4$
10 kHz	135Ω	$P_0 + 1,4 + 40$	10 kHz	$P_0 + 1,4$
$0,1 \times F_N$	135Ω	$P_0 + 1,4 + 40$	10 kHz	$P_0 + 1,4$
$0,275 \times F_N$	135Ω	$P_0 + 40$	10 kHz	P_0
$0,4 \times F_N$	135Ω	$P_0 - 2 + 40$	10 kHz	$P_0 - 2$
$0,475 \times F_N$	135Ω	$P_0 - 4,5 + 40$	10 kHz	$P_0 - 4,5$
$0,6 \times F_N$	135Ω	$P_0 - 14 + 40$	10 kHz	$P_0 - 14$
$0,9 \times F_N$	135Ω	$P_0 - 45 + 40$	10 kHz	$P_0 - 45$
$0,96 \times F_N$	135Ω	$P_1 + 40$	10 kHz	P_1
1.5 MHz	135Ω	-65	10 kHz	-105
1.5 MHz	135Ω	-50	1 MHz	-110
30 MHz	135Ω	-50	1 MHz	-110

The reference power levels, P_0 and P_1 , in Table 38 are given by the formulas below. Table 39 lists these values for few sample Principal frequencies.

$$P_0 = 10 \times \log_{10} \left(\frac{K_{SDSL}}{135} \right) - 10 \times \log_{10} \left(\frac{F_N}{F_0} \right)$$

$$P_1 = -57 - 15 \times \log_{10} \left(\frac{F_N}{F_0} \right)$$

$$K_{SDSL} = \begin{cases} 7.86 & F_N < 685 \text{ kHz} \\ 9.9 & F_N \geq 685 \text{ kHz} \end{cases}$$

$$F_0 = 1 \text{ kHz}$$

Table 39: Reference power levels, as a function of the Principle frequency. The table summarises some example values, calculated from their formulas.

F_N	67	131	174	259	344	430	515	686	771	kHz
P_0	-30.6	-33.5	-34.8	-36.5	-37.7	-38.7	-39.5	-40.7	-41.2	dBm/Hz
P_1	-84.4	-88.8	-90.6	-93.2	-95.0	-96.5	-97.7	-99.5	-100.3	dBm/Hz

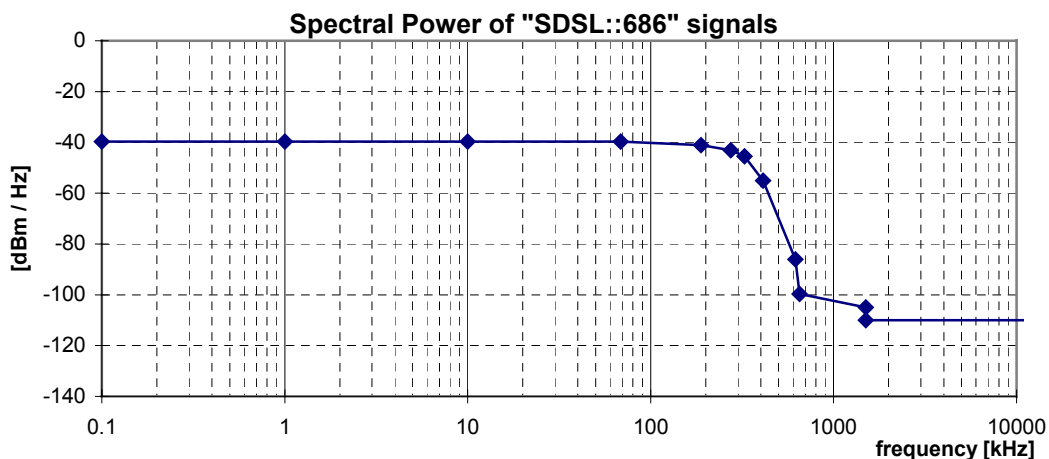

Figure 20: Spectral Power, for "SDSL::686" signals (at $F_N=686$ kHz), as specified in table 38. Note that these curves are dependent on the Principal frequency F_N , and that this figure shows an example only.

10.5.4 Unbalance about earth

To be compliant with this signal category, the balance of the signal that may flow through the LT-port or NT-port shall exceed minimum requirements, under the condition that the local loop wiring and its termination is well balanced. This can be verified by a longitudinal output voltage (LOV) and a longitudinal conversion loss (LCL) measurement at the source of that signal, as specified in sub-clause 13.3.2 and 13.3.3. The minimum LOV and LCL requirements hold for what can be observed at the ports of the Local Loop Wiring, when the Local Loop Wiring is replaced by an artificial impedance network described in sub-clause 13.3.2 and 13.3.3.

The differential termination impedance for LOV and LCL measurements shall be chosen equally to the design impedance $R_T=135 \Omega$ of the Signal Source under test.

The observed LOV shall have an rms voltage of below the value specified in table 40, measured in a power bandwidth B , centred over any frequency in the range from f_{\min} to f_{\max} , and averaged in any one second period. Compliance with

this limitation is required with a longitudinal terminating impedance having value $Z_L(\omega)=R_L+1/(j\omega C_L)$ for all frequencies between f_{\min} to f_{\max} . Sub clause 13.3.2 defines an example measurement method for longitudinal output voltage.

The observed LCL shall be higher than the lower limits given in figure 21. The LCL values of the associated break frequencies of this figure are given in table 41. Sub clause 13.3.3 defines an example measurement method for longitudinal conversion loss.

Reference: ETSI TS 101 524-1 [14], clause 9.3

Reference: ITU G.991.2 (draft) [16], clause 11.1

Table 40: Values for the LOV limits.

LOV	B	f_{\min}	f_{\max}	R_L	C_L
-50dBV	4 kHz	100 kHz	400 kHz	100 Ω	150 nF

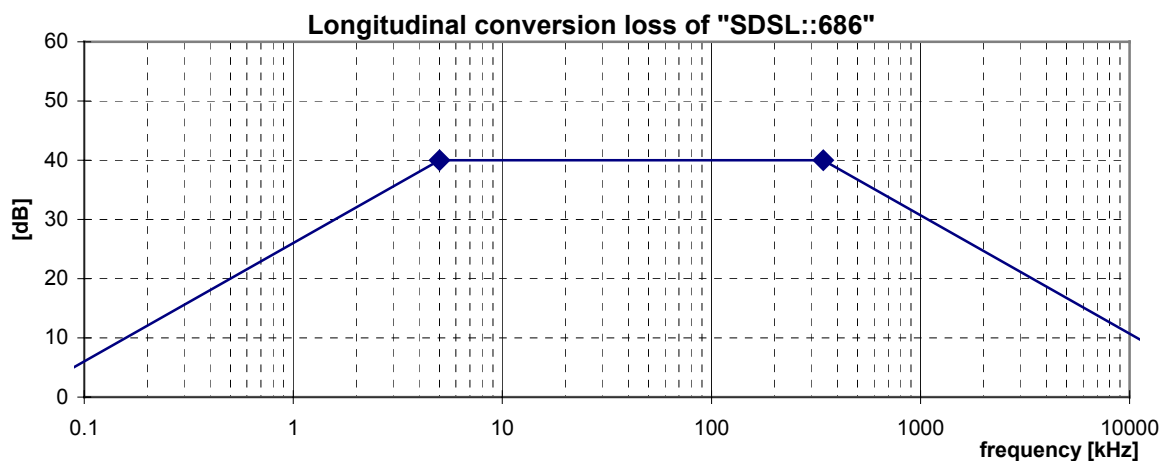

Figure 21: Minimum longitudinal conversion loss for a "SDSL::686" signal source.

Table 41: Frequencies and LCL values of the breakpoints of the LCL mask in figure 21.

Frequency	LCL
<0.05 kHz	0 dB
0.05 kHz	0 dB
5 kHz	40 dB
$1/2 \times F_N$	40 dB
$50 \times F_N$	0 dB
30 MHz	0 dB

10.5.5 Feeding Power (from the LT-port)

Power feeding is no integral part of this signal category, although it is not uncommon for SDSL services. To enable power feeding in combination with this signal category, refer to one of the power feeding classes summarized in clause 7.

10.6 "SDSL.asym::Fn" Signals

This category covers signals, generated by multi-rate SDSL transmission equipment on one or two wire pairs. This sub clause is based on ETSI SDSL standards [14,15] and on ITU draft Recommendation G.991.2 [16]. modulation used in these draft standards is Ungerboeck Coded Pulse Amplitude Modulation (UC-PAM), also known as Trellis Coded PAM (TC-PAM).

The SDSL standards specify both symmetric and asymmetric PSD masks. This signal description is dedicated to the symmetric variant. For the asymmetric PSD masks the naming convention is "SDSL.asym::Fn" where the phrase "Fn" is a placeholder for a number that is used as parameter F_N in the signal definition. Replacing "Fn" in the signal name by a value, changes the generic signal description into a specific description, since its value is required in the sub clauses below. It is referred to as the *Principal frequency* of the signal.

The Principal frequency F_N is indicative for the symbol rate [kbaud] that can be transported within these signal limits. A signal with a higher Principal Frequency occupies a wider spectrum. A signal with a lower Principal Frequency has a higher inband PSD.

The following four sub classes are defined:

- signal "SDSL.asym::686.NT", dedicated in [15] to 2048 kb/s upstream transmission
- signal "SDSL.asym::686.LT", dedicated in [15] to 2048 kb/s downstream transmission
- signal "SDSL.asym::771.NT", dedicated in [15] to 2304 kb/s upstream transmission
- signal "SDSL.asym::771.LT", dedicated in [15] to 2304 kb/s downstream transmission

Although this signal description is technology independent, several examples on how ETSI SDSL standards [14,15] make use of these signals are summarized in table 42. As a result, the bitrates in table 42, and their associated modulation parameters are informative only.

Table 42: Example on how the four subclasses of this signal category can be used for transporting data. The actual bit rates and modulation parameters are implementation dependent, and informative only.

Signal category	F_N [kHz]	Symbol Rate [kbaud]	Bit/symbol	Line Bit Rate [kb/s]
SDSL.asym::686.NT	686	685.33	3	2056
SDSL.asym::686.LT	686	685.33	3	2056
SDSL.asym::771.NT	771	770.67	3	2312
SDSL.asym::771.LT	771	770.67	3	2312

10.6.1 Total Signal Power

To be compliant with this signal category, the mean signal power into a resistive load of 135Ω shall not exceed a level of P_{\max} , measured within a frequency band from at least 100 Hz to 3 MHz. P_{\max} has the following values for the different SDSL signals:

- 16.75 dBm for "SDSL.asym::686.LT" signals
- 17.00 dBm for "SDSL.asym::686.NT" signals
- 15.25 dBm for "SDSL.asym::771.LT" signals
- 15.75 dBm for "SDSL.asym::771.NT" signals

Reference: ETSI TS 101 524-2 [15], clause 4.4.1 & 4.4.2

Reference: ITU G.991.2 (draft) [16], clause B.4.1 & B.4.2

10.6.2 Peak amplitude

To be compliant with this signal category, the nominal voltage peak of the largest signal pulse into a resistive load of 135Ω shall not exceed a level of $V_{\text{peak}} (\pm 7\%)$, measured within a frequency band from at least 100 Hz to 3 MHz. V_{peak} has the following values for the different SDSL signals:

- 16V for "SDSL.asym::686.LT" signals
- 16V for "SDSL.asym::686.NT" signals
- 13V for "SDSL.asym::771.LT" signals
- 13V for "SDSL.asym::771.NT" signals

The definition and measurement method of peak amplitude is specified in sub clause 13.1.

NOTE: No ETSI deliverable does specify this parameter.

10.6.3 Narrow-band signal power (upstream only)

This sub clause is dedicated to "SDSL.asym::686.NT" and "SDSL.asym::771.NT" signals only.

To be compliant with this signal category, the narrow-band signal power (NBSP) into a resistive load impedance R , shall not exceed the limits given in the tables in the following subsections, at any point in the frequency range 100 Hz to 30 MHz. Limits for intermediate frequencies can be found by drawing a straight line between the break points on a logarithmic (Hz) - linear (dB) scale. The NBSP is the average power P of a sending signal into a load resistance R , within a power bandwidth B . The measurement method of the NBSP is described in sub-clause 13.2.

Table 43 gives the break points of the power limits for the upstream asymmetric NBSP limits for the signals "SDSL.asym::686.NT" and "SDSL.asym::771.NT". Figures 22 and 23 illustrates the NBSP in a bandwidth-normalised way.

Reference: ETSI TS 101 524-2 [15], clause 4.4.2

Reference: ITU G.991.2 (draft) [16], clause B.4.2

Table 43: Break points of the narrow-band signal power P , as a function of the Principal frequency F_N of the signal category. The values for the parameters F_N , P_0 and P_1 are given in Table 44.

frequency f	Impedance R	Signal Level P [dBm]	Noise Bandwidth B	Spectral Power P/B [dBm/Hz]
0,1 kHz	135Ω	$P_0 + 1,4 + 20$	100 Hz	$P_0 + 1,4$
1 kHz	135Ω	$P_0 + 1,4 + 20$	100 Hz	$P_0 + 1,4$
1 kHz	135Ω	$P_0 + 1,4 + 30$	1 kHz	$P_0 + 1,4$
10 kHz	135Ω	$P_0 + 1,4 + 30$	1 kHz	$P_0 + 1,4$
10 kHz	135Ω	$P_0 + 1,4 + 40$	10 kHz	$P_0 + 1,4$
$0,1 \times F_N$	135Ω	$P_0 + 1,4 + 40$	10 kHz	$P_0 + 1,4$
$0,275 \times F_N$	135Ω	$P_0 + 40$	10 kHz	P_0
$0,4 \times F_N$	135Ω	$P_0 - 2 + 40$	10 kHz	$P_0 - 2$
$0,475 \times F_N$	135Ω	$P_0 - 4,5 + 40$	10 kHz	$P_0 - 4,5$
$0,6 \times F_N$	135Ω	$P_0 - 15 + 40$	10 kHz	$P_0 - 15$
$0,85 \times F_N$	135Ω	$P_0 - 45 + 40$	10 kHz	$P_0 - 45$
$0,96 \times F_N$	135Ω	$P_1 + 40$	10 kHz	P_1
1.5 MHz	135Ω	-65	10 kHz	-105
1.5 MHz	135Ω	-50	1 MHz	-110
30 MHz	135Ω	-50	1 MHz	-110

Table 44: The power levels and principle frequency for defining NBSP limits in table 43 for upstream asymmetric SDSL signals.

	SDSL.asym::686.NT	SDSL.asym::771.NT	
F_N	686	771	kHz
P_0	-37.7	-39.5	dBm/Hz
P_1	-99.5	-100.5	dBm/Hz

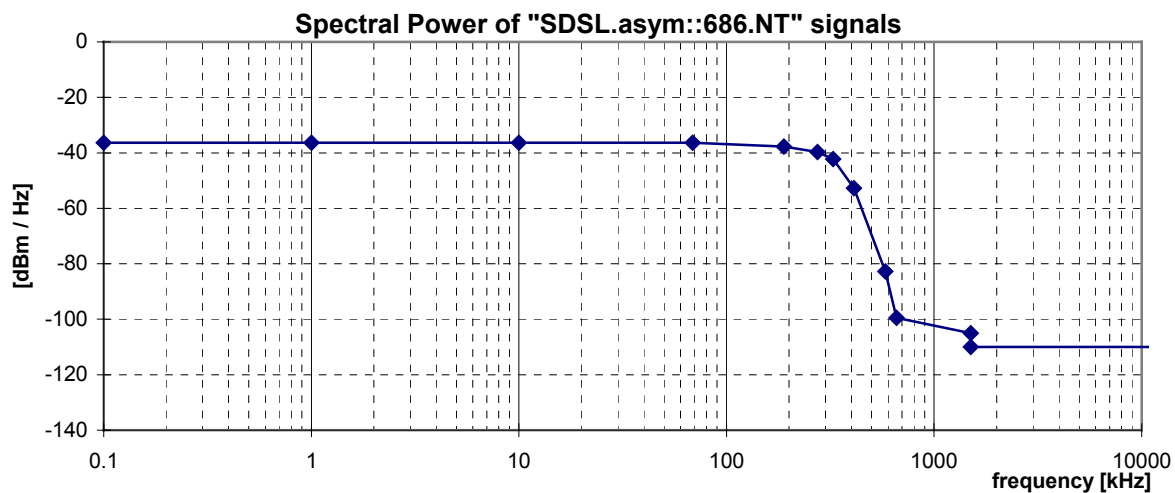

Figure 22: Spectral Power, for a "SDSL.asym::686.NT" signal, as specified in Table 43.

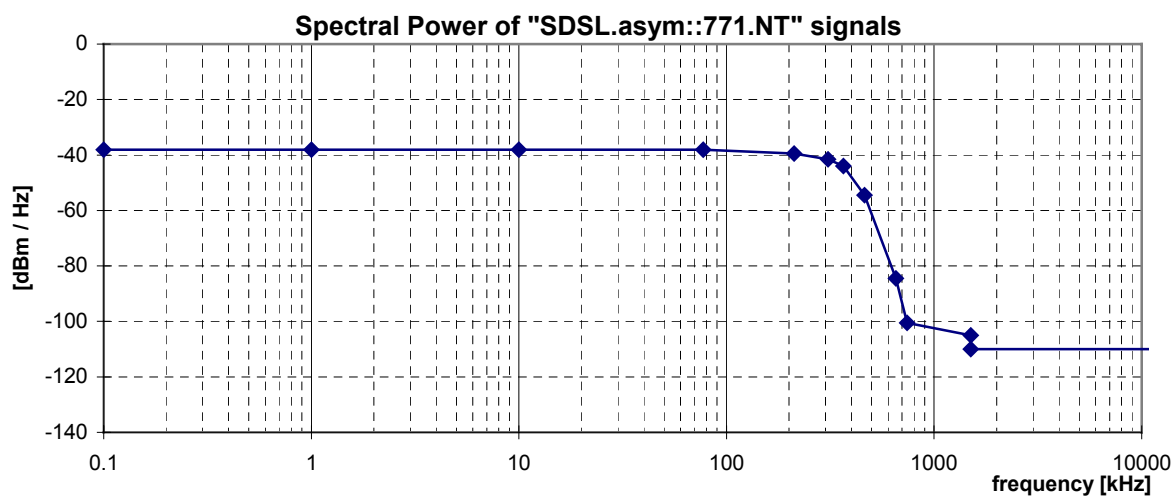

Figure 23: Spectral Power, for a "SDSL.asym::771.NT" signal, as specified in Table 43.

10.6.4 Narrow-band signal power (downstream only)

This sub clause is dedicated to “SDSL.asym::686.LT” and “SDSL.asym::771.LT” signals only.

To be compliant with this signal category, the narrow-band signal power (NBSP) into a resistive load impedance R , shall not exceed the limits given in the tables in the following subsections, at any point in the frequency range 100 Hz to 30 MHz. Limits for intermediate frequencies can be found by drawing a straight line between the break points on a logarithmic (Hz) - linear (dB) scale. The NBSP is the average power P of a sending signal into a load resistance R , within a power bandwidth B . The measurement method of the NBSP is described in sub-clause 13.2.

Table 45 gives the break points of the power limits for the upstream asymmetric NBSP limits for the signals “SDSL.asym::686.LT” and “SDSL.asym::771.LT”. Figures 24 and 25 illustrates the NBSP in a bandwidth-normalised way.

Reference: ETSI TS 101 524-2 [15], clause 4.4.2

Reference: ITU G.991.2 (draft) [16], clause B.4.2

Table 45: Break points of the narrow-band signal power P , as a function of the Principal frequency F_N of the signal category. The values for the parameters F_N , P_0 and P_1 used in table 45 are given in table 46.

frequency f	Impedance R	Signal Level P [dBm]	Noise Bandwidth B	Spectral Power P/B [dBm/Hz]
0,1 kHz	135Ω	$P_0 + 1,4 + 20$	100 Hz	$P_0 + 1,4$
1 kHz	135Ω	$P_0 + 1,4 + 20$	100 Hz	$P_0 + 1,4$
1 kHz	135Ω	$P_0 + 1,4 + 30$	1 kHz	$P_0 + 1,4$
10 kHz	135Ω	$P_0 + 1,4 + 30$	1 kHz	$P_0 + 1,4$
10 kHz	135Ω	$P_0 + 1,4 + 40$	10 kHz	$P_0 + 1,4$
$0,1 \times F_N \times w$	135Ω	$P_0 + 1,4 + 40$	10 kHz	$P_0 + 1,4$
$0,3 \times F_N \times w$	135Ω	$P_0 + 0,25 + 40$	10 kHz	$P_0 + 0,25$
$0,4 \times F_N \times w$	135Ω	$P_0 - 1,1 + 40$	10 kHz	$P_0 - 1,1$
$0,45 \times F_N \times w$	135Ω	$P_0 - 2,25 + 40$	10 kHz	$P_0 - 2,25$
$0,5 \times F_N \times w$	135Ω	$P_0 - 4,5 + 40$	10 kHz	$P_0 - 4,5$
$0,6 \times F_N \times w$	135Ω	$P_0 - 14 + 40$	10 kHz	$P_0 - 14$
$0,95 \times F_N \times w$	135Ω	$P_0 - 45 + 40$	10 kHz	$P_0 - 45$
$1,1 \times F_N \times w$	135Ω	$P_1 + 40$	10 kHz	P_1
1.5 MHz	135Ω	-65	10 kHz	-105
1.5 MHz	135Ω	-50	1 MHz	-110
30 MHz	135Ω	-50	1 MHz	-110

NOTE: w reflects how much "excess bandwidth" is used for the signals.

Table 46: The Principle frequency and power levels for upstream asymmetric SDSL signals.

	SDSL.asym::686.LT	SDSL.asym::771.LT	
F_N	686	771	kHz
w	1.6	1.5	
P_0	-40.4	-42.2	dBm/Hz
P_1	-103.5	-104	dBm/Hz

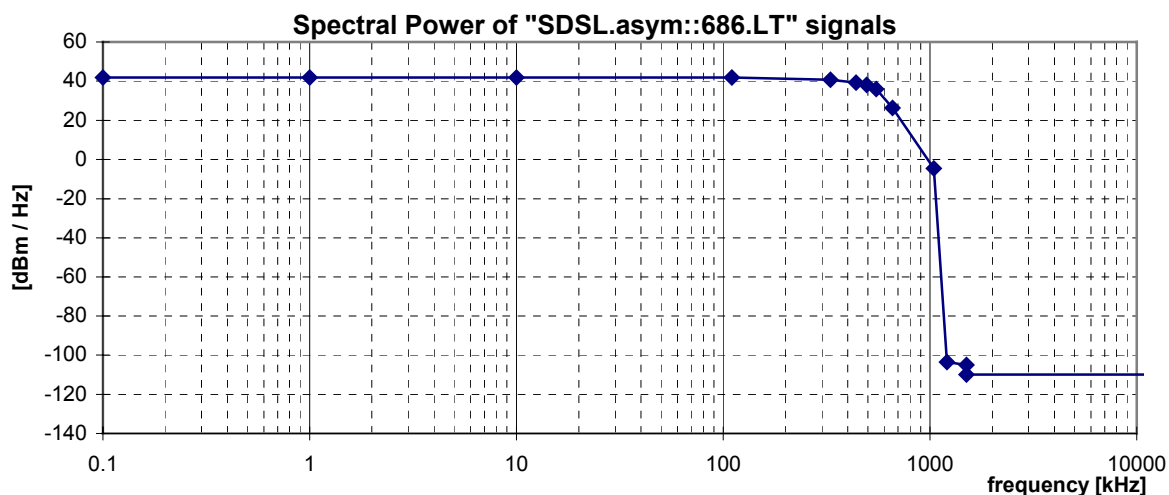

Figure 24: Spectral Power, for "SDSL.asym::686.LT" signal, as specified in table 45.

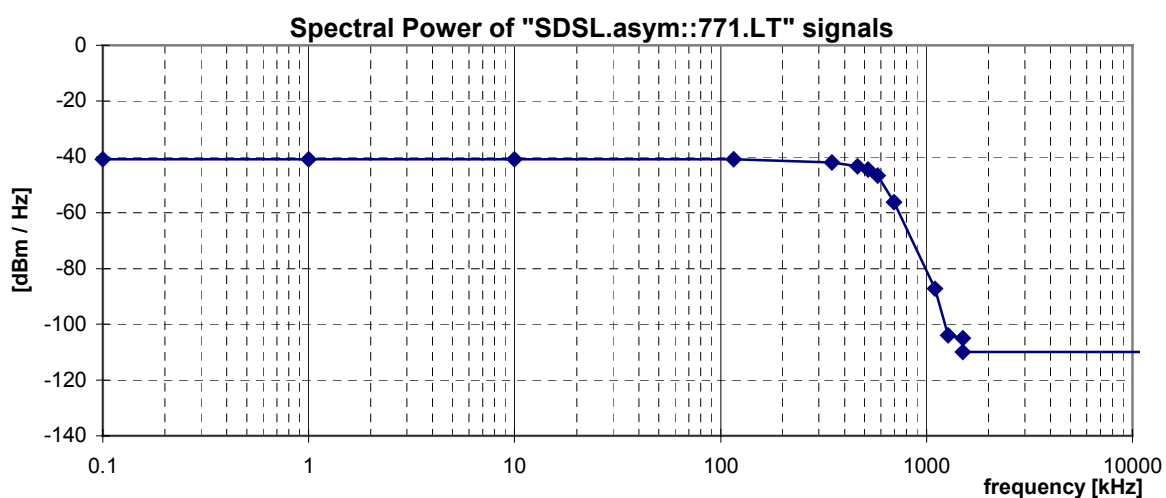

Figure 25: Spectral Power, for "SDSL.asym::771.LT" signal, as specified in table 45.

10.6.5 Unbalance about earth

As for "SDSL::Fn" signal category

10.6.6 Feeding Power (from the LT-port)

Power feeding is no integral part of this signal category, although it is not uncommon for SDSL services. To enable power feeding in combination with this signal category, refer to one of the power feeding classes summarized in clause 7.

10.7 "Proprietary.SymDSL.CAP.A::Fn" Signals

This category covers signals, generated by Proprietary multi-rate SymDSL transmission equipment on one (or two) wire-pairs. This signal is labelled as *Proprietary*, since it is not covered by ETSI, ITU nor ANSI product standards.

This signal definition is linecode independent, but dedicated to signals from transmission equipment for variable bit-rate leased lines that are using CAP modulation. These definitions are partly based on the ETSI specifications on HDSL equipment [13].

In the naming convention "Proprietary.SymDSL.CAP.A::Fn", is the phrase "Fn" a placeholder for a number that is used as parameter F_N in the signal definition. Replacing "Fn" in the signal name by a value, changes the generic signal description into a specific description, since its value is required in the subclauses below. It is referred to as the *Principal frequency* of the signal.

The Principal frequency F_N is indicative for the maximum symbol rate [kbaud] that can be transported within these signal limits. A signal with a higher Principal Frequency occupies a wider spectrum. Values between 72 kHz and 387 kHz are commonly used.

Table 47 gives several examples on how to use the naming convention for specifying the actual parameter value F_N . It also illustrates some (informative) bitrates that can be transported within these signal limits, when using the associated (informative) modulation parameters. These are examples only, other system implementations may use the same signal limits in a different way.

Table 47: Example on how the naming convention relates to the actual parameter value F_N that is used in the subclauses below to specify the signal limits of this signal category. The bitrates and modulation parameters are informative only, and implementation dependent

Signal category	F_N [kHz]	Baud Rate [kbaud]	Bit Rate [kb/s]	Bit/Symbol	Constellation size
Proprietary.SymDSL.CAP.A::72	72	72	144	2	8
Proprietary.SymDSL.CAP.A::91	91	91	272	3	16
Proprietary.SymDSL.CAP.A::133	133	133	400	3	16
Proprietary.SymDSL.CAP.A::176	176	176	528	3	16
Proprietary.SymDSL.CAP.A::261	261	261	784	3	16
Proprietary.SymDSL.CAP.A::261	261	261	1040	4	32
Proprietary.SymDSL.CAP.A::311	311	311	1552	5	64
Proprietary.SymDSL.CAP.A::344	344	344	2064	6	128
Proprietary.SymDSL.CAP.A::387	387	387	2320	6	128

A signal (per wire-pair) can be classified as a "Proprietary.SymDSL.CAP.A::Fn" signal if it is compliant with all subclauses below, *and* if parameter "Fn" is specified by a numerical value.

Unless otherwise indicated, the following signal specifications apply with a resistive load impedance of 135 Ω , and does not apply to the DC remote power feeding (if any).

10.7.1 Total signal power

To be compliant with this signal category, the mean signal power into a resistive load of 135 Ω shall not exceed a level of 14 dBm, measured within a frequency band from at least 100 Hz to 1 MHz.

NOTE: No ETSI deliverable does specify this parameter.

10.7.2 Peak amplitude

To be compliant with this signal category, the nominal voltage peak of the largest signal pulse into a resistive load of 135 Ω shall not exceed a level of 6,5 V (13 V peak-peak), measured within a frequency band from at least 100 Hz to 1 MHz. The definition and measurement method of peak amplitude is specified in sub clause 13.1.

NOTE: No ETSI deliverable does specify this parameter.

10.7.3 Narrow-band signal power (NBSP)

To be compliant with this signal category, the narrow-band signal power (NBSP) into a resistive load impedance R , shall not exceed the limits given in table 48, at any point in the frequency range 100 Hz to 30 MHz. This table specifies the break points of these limits. Limits for intermediate frequencies can be found by drawing a straight line between the break points on a logarithmic (Hz) - linear (dB) scale. Figure 26 illustrates the NBSP in a bandwidth-normalized way.

The NBSP is the average power P of a sending signal into a load resistance R , within a *power* bandwidth B . The measurement method of the NBSP is described in subclause 13.2.

NOTE: No ETSI deliverable does specify this parameter.

Table 48: Break points of the narrow-band signal power P , as a function of the Principal frequency F_N of the signal category (see table 47). The parameter values for F_L , and α are defined as $F_L = 10$ kHz, and $\alpha = 0,15$

Centre frequency f	Impedance R	Signal Level P	Power bandwidth B	Spectral Power P/B
0,1 kHz	135 Ω	-50 dBm	100 Hz	-70 dBm/Hz
4 kHz	135 Ω	-39 dBm	100 Hz	-59 dBm/Hz
4 kHz	135 Ω	-29 dBm	1 kHz	-59 dBm/Hz
10 kHz	135 Ω	-12 dBm	1 kHz	-42 dBm/Hz
10 kHz	135 Ω	-12 dBm	1 kHz	-42 dBm/Hz
40 kHz	135 Ω	-9 dBm	1 kHz	-39 dBm/Hz
$F_L + F_N$	135 Ω	-9 dBm	1 kHz	-39 dBm/Hz
$F_L + (1+\alpha/2) \times F_N$	135 Ω	-12 dBm	1 kHz	-42 dBm/Hz
$F_L + (1+\alpha) \times F_N$	135 Ω	-29 dBm	1 kHz	-59 dBm/Hz
500 kHz	135 Ω	-46 dBm	1 kHz	-76 dBm/Hz
2 MHz	135 Ω	-80 dBm	1 kHz	-110 dBm/Hz
2 MHz	135 Ω	-50 dBm	1 MHz	-110 dBm/Hz
30 MHz	135 Ω	-50 dBm	1 MHz	-110 dBm/Hz

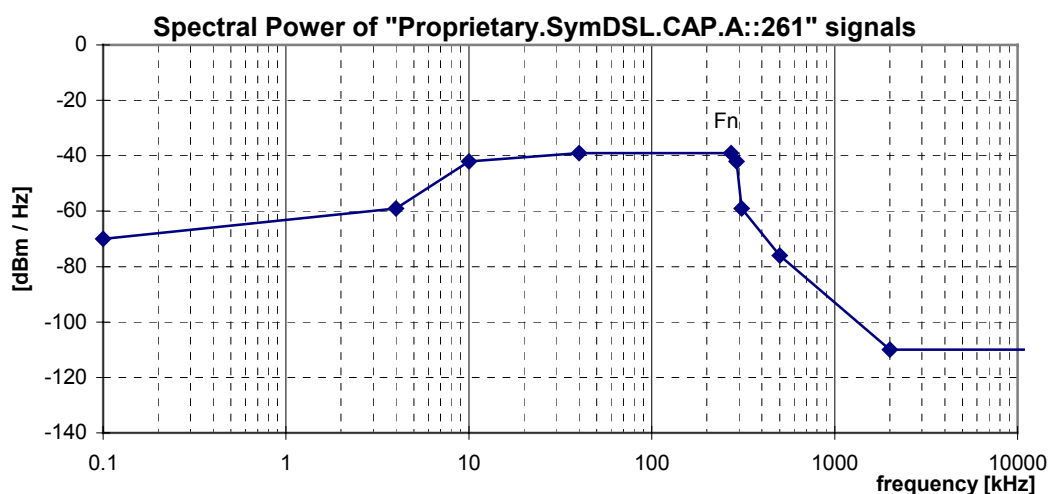

NOTE: These curves are dependent on the Principal frequency F_N , and that this figure shows an example only.

Figure 26: Spectral Power, for "Proprietary.SymDSL.CAP.A::261" signals (at $F_N=261$ kHz), as specified in table 48

10.7.4 Unbalance about earth

To be compliant with this signal category, the balance of the signal that may flow through the LT-port or NT-port shall exceed minimum requirements, under the condition that the local loop wiring and its termination is well balanced. This can be verified by a longitudinal output voltage (LOV) and a longitudinal conversion loss (LCL) measurement at the source of that signal, as specified in subclauses 13.3.2 and 13.3.3. The minimum LOV and LCL requirements hold for what can be observed at the ports of the Local Loop Wiring, when the Local Loop Wiring is replaced by an artificial impedance network described in subclauses 13.3.2 and 13.3.3.

The differential termination impedance for LOV and LCL measurements shall be chosen equally to the design impedance $R_T=135\ \Omega$ of the Signal Source under test.

The observed LOV shall have an rms voltage of below the value specified in table 49, measured in a power bandwidth B , centred over any frequency in the range from f_{\min} to f_{\max} , and averaged in any one second period. Compliance with this limitation is required with a longitudinal terminating impedance having value $Z_L(\omega)=R_L+1/(j\omega C_L)$ for all frequencies between f_{\min} to f_{\max} . Subclause 13.3.2 defines an example measurement method for longitudinal output voltage.

The observed LCL shall be higher than the lower limits given in figure 27. The LCL values of the associated break frequencies of this figure are given in table 50. Subclause 13.3.3 defines an example measurement method for longitudinal conversion loss.

NOTE: No ETSI deliverable does specify this parameter.

Table 49: Values for the LOV limits

LOV	B	f_{\min}	f_{\max}	R_L	C_L
-46 dBV	10 kHz	5,1 kHz	500 kHz	100 Ω	150 nF

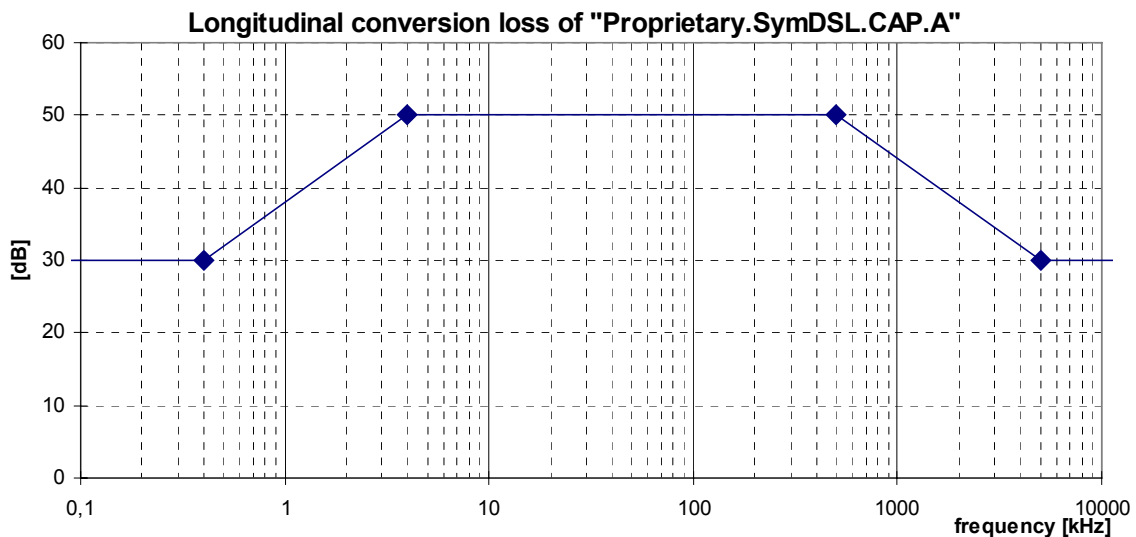

Figure 27: Minimum longitudinal conversion loss for a "Proprietary.SymDSL.CAP.A::261" signal source

Table 50: Frequencies and LCL values of the breakpoints of the LCL mask in figure 27

Frequency	LCL
< 0,4 kHz	30 dB
4 kHz	50 dB
500 kHz	50 dB
5 MHz	30 dB
30 MHz	30 dB

10.8 "Proprietary.SymDSL.CAP.B::Fn" Signals

This category covers signals, generated by Proprietary multi-rate SymDSL transmission equipment. This signal is labelled as *proprietary*, since it is not covered by ETSI, ITU nor ANSI product standards.

The pass-band signal definition is linecode independent, but derived from CAP based HDSL signals defined in annex B of [13]. Their definition is driven by the deployment of proprietary multi-rate symmetric HDSL transmission equipment based on CAP modulation. This category covers other CAP implementation than covered by "Proprietary.SymDSL.CAP.A" signals, without significant advantages or disadvantages.

In the naming convention "Proprietary.SymDSL.CAP.B::Fn", is the phrase "Fn" a placeholder for a number that is used as parameter F_N in the signal definition. Replacing "Fn" in the signal name by a value, changes the generic signal description into a specific description, since its value is required in the subclauses below. It is referred to as the *Principal frequency* of the signal.

The Principal frequency F_N is indicative for the maximum symbol rate [kbaud] that can be transported within these signal limits. A signal with a higher Principal Frequency occupies a wider spectrum. Values between 72 kHz and 387 kHz are commonly used.

Table 51 gives several examples on how to use the naming convention for specifying the actual parameter value F_n . It also illustrates some (informative) bitrates that can be transported within these signal limits, when using the associated (informative) modulation parameters. These are examples only, other system implementations may use the same signal limits in a different way.

Table 51: Example on how the naming convention relates to the actual parameter value F_N that is used in the subclauses below to specify the signal limits of this signal category. The bitrates and modulation parameters are informative only, and implementation dependent

Signal category	F_N [kHz]	Symbol Rate [kBaud]	Bits per Symbol	Bit Rate [kb/s]	Constellation size
Propriety.SymDSL.CAP.B::72	72	72	4	288	32
Propriety.SymDSL.CAP.B::100	100	100	4	400	32
Propriety.SymDSL.CAP.B::132	132	132	4	528	32
Propriety.SymDSL.CAP.B::196	196	196	4	784	32
Propriety.SymDSL.CAP.B::208	208	208	5	1 040	64
Propriety.SymDSL.CAP.B::310	311	310,4	5	1 552	64
Propriety.SymDSL.CAP.B::344	344	344	6	2 064	128
Propriety.SymDSL.CAP.B::387	387	386,7	6	2 320	128

A signal (per wire-pair) can be classified as a "Proprietary.SymDSL.CAP.B::Fn" signal if it is compliant with all subclauses below, *and* if parameter "Fn" is specified by a numerical value.

Unless otherwise indicated, the following signal specifications apply with a resistive load impedance of 135 Ω , and does not apply to the DC remote power feeding (if any).

10.8.1 Total signal power

To be compliant with this signal category, the mean signal power into a resistive load of 135 Ω shall not exceed a level of 14 dBm, measured within a frequency band from at least 100 Hz to 1 MHz.

NOTE: No ETSI deliverable does specify this parameter.

10.8.2 Peak amplitude

To be compliant with this signal category, the nominal voltage peak of the largest signal pulse into a resistive load of 135 Ω shall not exceed a level of 7,4 V measured within a frequency band from at least 100 Hz to 1 MHz. The definition and measurement method of peak amplitude is specified in sub clause 13.1.

NOTE: No ETSI deliverable does specify this parameter.

10.8.3 Narrow-band signal power (NBSP)

To be compliant with this signal category, the narrow-band signal power (NBSP) into a resistive load impedance R , shall not exceed the limits given in table 52, at any point in the frequency range 100 Hz to 30 MHz. This table specifies the break points of these limits. Limits for intermediate frequencies can be found by drawing a straight line between the break points on a logarithmic (Hz) - linear (dB) scale. Figure 28 illustrates the NBSP in a bandwidth-normalized way.

The NBSP is the average power P of a sending signal into a load resistance R , within a *power* bandwidth B . The measurement method of the NBSP is described in subclause 13.2.

NOTE: No ETSI deliverable does specify this parameter.

Table 52: Break points of the narrow-band signal power P , as a function of the Principal frequency F_N of the signal category (see table 51)

Centre frequency f	Impedance R	Signal Level P	Power bandwidth B	Spectral Power P/B
0,1 kHz	135 Ω	A-37 dBm	100 Hz	A-17 dBm/Hz
4 kHz	135 Ω	A-37 dBm	100 Hz	A-17 dBm/Hz
4 kHz	135 Ω	A-47 dBm	1 kHz	A-17 dBm/Hz
9 kHz	135 Ω	A-30 dBm	1 kHz	A dBm/Hz
$F_L + F_N$	135 Ω	A-30 dBm	1 kHz	A dBm/Hz
$F_L + (1+\alpha/2) \times F_N$	135 Ω	A-33 dBm	1 kHz	A-3 dBm/Hz
$F_L + (1+\alpha) \times F_N$	135 Ω	A-50 dBm	1 kHz	A-20 dBm/Hz
500 kHz	135 Ω	-46 dBm	1 kHz	-76 dBm/Hz
2 MHz	135 Ω	-80 dBm	1 kHz	-110 dBm/Hz
2 MHz	135 Ω	-50 dBm	1 MHz	-110 dBm/Hz
30 MHz	135 Ω	-50 dBm	1 MHz	-110 dBm/Hz
$F_L = 10$ kHz	$\alpha = 0,15$	$A = 13,5 - 10 \times \log_{10}(F_N/F_0) + 1$ dBm/Hz	$F_0 = 1$ Hz	

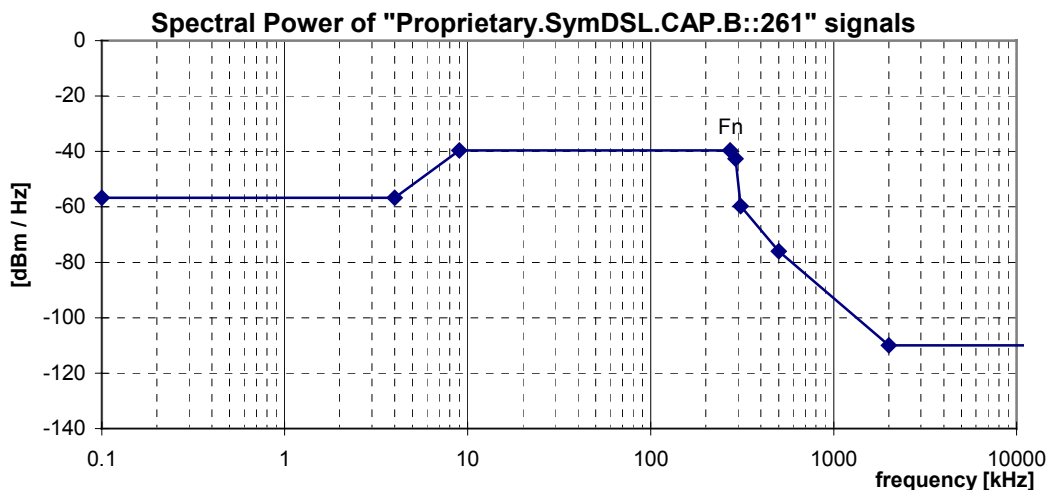

NOTE: These curves are dependent on the Principal frequency F_N , and that this figure shows an example only.

Figure 28: Spectral Power, for "Proprietary.SymDSL.CAP.B::261" signals (at $F_N = 261$ kHz), as specified in table 52

10.8.4 Unbalance about earth

To be compliant with this signal category, the balance of the signal that may flow through the LT-port or NT-port shall exceed minimum requirements, under the condition that the local loop wiring and its termination is well balanced. This can be verified by a longitudinal output voltage (LOV) and a longitudinal conversion loss (LCL) measurement at the source of that signal, as specified in subclauses 13.3.2 and 13.3.3. The minimum LOV and LCL requirements hold for what can be observed at the ports of the Local Loop Wiring, when the Local Loop Wiring is replaced by an artificial impedance network described in subclauses 13.3.2 and 13.3.3.

The differential termination impedance for LOV and LCL measurements shall be chosen equally to the design impedance $R_T = 135 \Omega$ of the Signal Source under test.

The observed LOV shall have an rms voltage of below the value specified in table 53, measured in a power bandwidth B , centred over any frequency in the range from f_{\min} to f_{\max} , and averaged in any one second period. Compliance with this limitation is required with a longitudinal terminating impedance having value $Z_L(\omega) = R_L + 1/(j\omega C_L)$ for all frequencies between f_{\min} to f_{\max} . Subclause 13.3.2 defines an example measurement method for longitudinal output voltage.

The observed LCL shall be higher than the lower limits given in figure 29. The LCL values of the associated break frequencies of this figure are given in table 54. Subclause 13.3.3 defines an example measurement method for longitudinal conversion loss.

NOTE: No ETSI deliverable does specify this parameter.

Table 53: Values for the LOV limits

LOV	B	f_{\min}	f_{\max}	R_L	C_L
-46 BV	10 kHz	5,1 kHz	500 kHz	100 Ω	150 nF

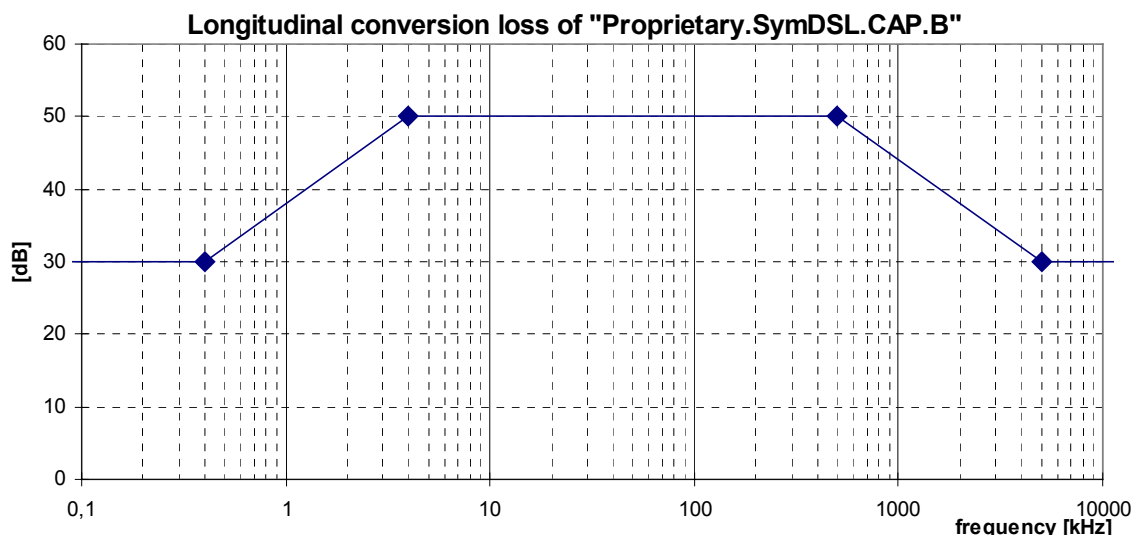

Figure 29: Minimum longitudinal conversion loss for a "Proprietary.SymDSL.CAP.B::261" signal source

Table 54: Frequencies and LCL values of the breakpoints of the LCL mask in figure 29

Frequency	LCL
<0,4 kHz	30 dB
4 kHz	50 dB
500 kHz	50 dB
5 MHz	30 dB
30 MHz	30 dB

10.9 "Proprietary.SymDSL.CAP.C::Fn" Signals

This category covers signals, generated by Proprietary multi-rate SymDSL transmission equipment on one wire-pair. This signal is labelled as *Proprietary*, since it is not covered by ETSI, ITU nor ANSI product standards.

This signal definition is linecode independent, but dedicated to signals from transmission equipment for variable bit-rate leased lines that are using CAP or QAM modulation..

In the naming convention "Proprietary.SymDSL.CAP.C::Fn", is the phrase "Fn" a placeholder for a number that is used as parameter F_N in the signal definition. Replacing "Fn" in the signal name by a value, changes the generic signal description into a specific description, since its value is required in the subclauses below. It is referred to as the *Principal frequency* of the signal.

The Principal frequency F_N is indicative for the maximum symbol rate [kbaud] that can be transported within these signal limits. A signal with a higher Principal Frequency occupies a wider spectrum. Values between 72 kHz and 128 kHz are commonly used.

Table 55 gives several examples on how to use the naming convention for specifying the actual parameter value F_n . It also illustrates some (informative) bitrates that can be transported within these signal limits, when using the associated (informative) modulation parameters. These are examples only, other system implementations may use the same signal limits in a different way.

Table 55: Example on how the naming convention relates to the actual parameter value F_N that is used in the subclauses below to specify the signal limits of this signal category. The bitrates and modulation parameters are informative only, and implementation dependent

Signal category	F_N [kHz]	Baud Rate [kbaud]	Bit Rate [kb/s]	Bit/Symbol	Constellation size
Proprietary.SymDSL.CAP.C::72	72	72	144	2	8
Proprietary.SymDSL.CAP.C::88	88	88	264	3	16
Proprietary.SymDSL.CAP.C::96	96	96	288	3	16
Proprietary.SymDSL.CAP.C::112	112	112	336	3	16
Proprietary.SymDSL.CAP.C::128	128	128	384	3	16

A signal can be classified as a "Proprietary.SymDSL.CAP.C::Fn" signal if it is compliant with all subclauses below, *and* if parameter "Fn" is specified by a numerical value.

Unless otherwise indicated, the following signal specifications apply with a resistive load impedance of 135 Ω .

10.9.1 Total signal power

To be compliant with this signal category, the mean signal power into a resistive load of 135 Ω shall not exceed a level of 14 dBm, measured within a frequency band from at least 100 Hz to 1 MHz.

NOTE: No ETSI deliverable does specify this parameter.

10.9.2 Peak amplitude

To be compliant with this signal category, the nominal voltage peak of the largest signal pulse into a resistive load of 135 Ω shall not exceed a level of 7,5 V (15V peak-peak), measured within a frequency band from at least 100 Hz to 1 MHz.

The definition and measurement method of peak amplitude is specified in sub clause 13.1.

NOTE: No ETSI deliverable does specify this parameter.

10.9.3 Narrow-band signal power (NBSP)

To be compliant with this signal category, the narrow-band signal power (NBSP) into a resistive load impedance R , shall not exceed the limits given in table 56, at any point in the frequency range 100 Hz to 30 MHz. This table specifies the break points of these limits. Limits for intermediate frequencies can be found by drawing a straight line between the break points on a logarithmic (Hz) - linear (dB) scale. Figure 30 illustrates the NBSP in a bandwidth-normalized way.

The NBSP is the average power P of a sending signal into a load resistance R , within a *power* bandwidth B . The measurement method of the NBSP is described in subclause 13.2.

NOTE: No ETSI deliverable does specify this parameter.

Table 56: Break points of the narrow-band signal power P, as a function of the Principal frequency F_N of the signal category (see table 55)

Centre frequency f (kHz)	Impedance R	Signal Level P (dBm)	Power bandwidth B	Spectral Power P/B (dBm/Hz)	
0.51	135Ω	-56	1 kHz	-86	A
4	135Ω	-56	1 kHz	-86	
10	135Ω	-30	1 kHz	-60	
10	135Ω	-20	10 kHz	-60	
$0.12 \times F_N + F_L$	135Ω	$7.6 - 0.380 \times f/f_0$	10 kHz	$-32.4 - 0.380 \times f/f_0$	
$0.23 \times F_N + F_L$	135Ω	$11.4 - 0.184 \times f/f_0$	10 kHz	$-28.6 - 0.184 \times f/f_0$	
$0.66 \times F_N + F_L$	135Ω	$11.2 - 0.0792 \times f/f_0$	10 kHz	$-28.8 - 0.0792 \times f/f_0$	
$1.06 \times F_N + F_L$	135Ω	$4.3 - 0.0128 \times f/f_0$	10 kHz	$-35.7 - 0.0128 \times f/f_0$	
$3.50 \times F_N$	135Ω	$-38.2 - 0.0121 \times f/f_0$	10 kHz	$-78.2 - 0.0121 \times f/f_0$	
$3.90 \times F_N$	135Ω	$-38.2 - 0.0108 \times f/f_0$	10 kHz	$-78.2 - 0.0108 \times f/f_0$	
$(-161 \times F_N + 0.295 \times F_N^2) / (-31.8 + 0.0421 \times F_N)$	135Ω	-50	10 kHz	-90	
30000	135Ω	-50	10 kHz	-90	
$(-161 \times F_N + 0.295 \times F_N^2) / (-31.8 + 0.0421 \times F_N)$	135Ω	-30	1 MHz	-90	B
$7.00 \times F_N$	135Ω	-50	1 MHz	-110	
30000	135Ω	-50	1 MHz	-110	
$F_L=10\text{kHz}$		$f = \text{centre freq (Hz)}$		$f_0=1 \text{ kHz}$	

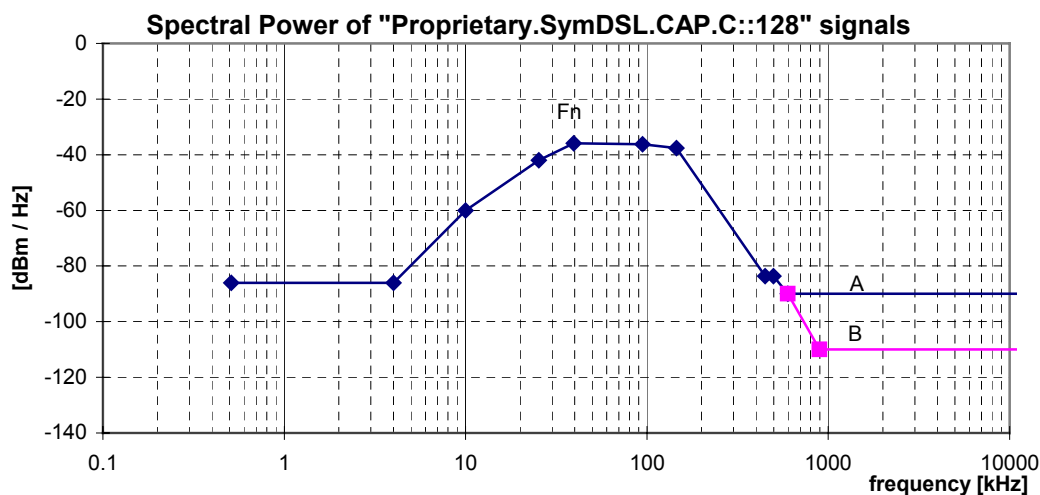

NOTE: These curves are dependent on the Principal frequency F_N , and that this figure shows an example only.

Figure 30: Spectral Power, for "Proprietary.SymDSL.CAP.C::128" signals (at $F_N = 128 \text{ kHz}$), as specified in table 56

10.9.4 Unbalance about earth

To be compliant with this signal category, the balance of the signal that may flow through the LT-port or NT-port shall exceed minimum requirements, under the condition that the local loop wiring and its termination is well balanced. This can be verified by a longitudinal output voltage (LOV) and a longitudinal conversion loss (LCL) measurement at the source of that signal, as specified in subclauses 13.3.2 and 13.3.3. The minimum LOV and LCL requirements hold for what can be observed at the ports of the Local Loop Wiring, when the Local Loop Wiring is replaced by an artificial impedance network described in subclauses 13.3.2 and 13.3.3.

The differential termination impedance for LOV and LCL measurements shall be chosen equally to the design impedance $R_T = 135 \Omega$ of the Signal Source under test.

The observed LOV shall have an rms voltage of below the value specified in table 57, measured in a power bandwidth **B**, centred over any frequency in the range from f_{\min} to f_{\max} , and averaged in any one second period. Compliance with this limitation is required with a longitudinal terminating impedance having value $Z_L(\omega) = R_L + 1/(j\omega C_L)$ for all frequencies between f_{\min} to f_{\max} . Subclause 13.3.2 defines an example measurement method for longitudinal output voltage.

The observed LCL shall be higher than the lower limits given in figure 31. The LCL values of the associated break frequencies of this figure are given in table 58. Subclause 13.3.3 defines an example measurement method for longitudinal conversion loss.

NOTE: No ETSI deliverable does specify this parameter.

Table 57: Values for the LOV limits

LOV	B	f_{\min}	f_{\max}	R_L	C_L
-46 BV	10 kHz	5,1 kHz	225 kHz	100 Ω	150 nF

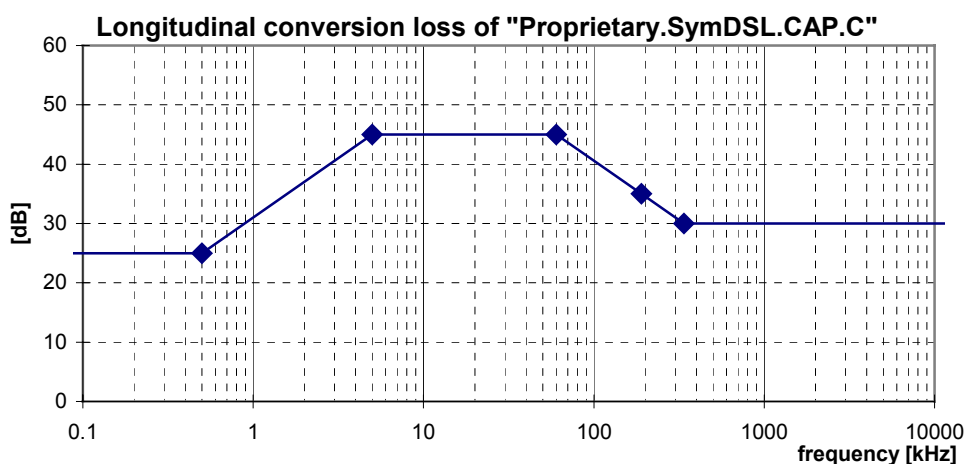

Figure 31: Minimum longitudinal conversion loss for a "Proprietary.SymDSL.CAP.C::Fn" signal source

Table 58: Frequencies and LCL values of the breakpoints of the LCL mask in figure 31

Frequency	LCL
< 0,5 kHz	25 dB
5 kHz	45 dB
60 kHz	45 dB
190 kHz	35 dB
337 kHz	30 dB
30 MHz	30 dB

10.10 "Proprietary.SymDSL.PAM::Fn" Signals

This category covers signals, generated by Proprietary multi-rate SymDSL transmission equipment on a single wire pair. This signal is labelled as *Proprietary*, since it is not covered by ETSI, ITU nor ANSI product standards.

This signal definition is linecode independent, but dedicated to signals from transmission equipment that are using PAM modulation.

In the naming convention "Proprietary.SymDSL.PAM::Fn", is the phrase "Fn" a placeholder for a number that is used as parameter F_N in the signal definition. Replacing "Fn" in the signal name by a value, changes the generic signal description into a specific description, since its value is required in the subclauses below. It is referred to as the *Principal frequency* of the signal.

The Principal frequency F_N is indicative for the maximum symbol rate [kbaud] that can be transported within these signal limits. A signal with a higher Principal Frequency occupies a wider spectrum. The subclause below are defined for all Principal frequencies between 80 kHz and 264 kHz.

Table 59 gives several examples on how to use the naming convention for specifying the actual parameter value F_n . It also illustrates some (informative) bitrates that can be transported within these signal limits, when using the associated (informative) modulation parameters. These are examples only, other system implementations may use the same signal limits in a different way.

Table 59: Naming convention for parameter F_N

Signal category	F_N [kHz]		Baud Rate [kbaud]	Bit/symbol	Bit Rate [kb/s]
Proprietary.SymDSL.PAM::80	80 kHz		80	2	160
Proprietary.SymDSL.PAM::258	258 kHz		258	4	1 032
Proprietary.SymDSL.PAM::264	264 kHz		264	3	792
NOTE: Example on how the naming convention relates to the actual parameter value F_N that is used in the subclauses below to specify the signal limits of this signal category. The actual bitrates and modulation parameters are implementation dependent, and informative only. They are included here to illustrate that different bitrates can be carried by signals having the same Principal frequency.					

Two slightly different additional variants are identified for all signals with specified Principal Frequency:

- option A signals, are dedicated to Ungerboeck Coded PAM with 2, 3 or 4 bits per symbol (before encoding);
- option B signals, are dedicated to 2B1Q linecoded signals.

A signal can be classified as a "Proprietary.SymDSL.PAM::Fn" signal if it is compliant with all subclauses below and if parameter "Fn" is specified by a numerical value.

NOTE: The narrow band signal power (NBSP) of "Proprietary.SymDSL.PAM::Fn" signals, having a Principal frequency between 80 kHz to 141,3 kHz, also fit under the NBSP mask of ISDN.2B1Q signals. This does not hold for the Peak amplitude and Unbalance about earth, so these signal limits are not 100 % compliant with ISDN.2B1Q signals.

10.10.1 Total Signal Power

To be compliant with this signal category, the mean signal power into a resistive load of 135 Ω shall not exceed a level of 14 dBm, measured within a frequency band from at least 100 Hz to $2 \times F_N$.

NOTE: No ETSI deliverable does specify this parameter.

10.10.2 Peak amplitude

To be compliant with this signal category, the nominal voltage peak of the largest signal pulse into a resistive load of 135Ω shall not exceed a level of $V_{\text{peak}} (\pm 7 \%)$, measured within a frequency band from at least 100 Hz to $F_N \times 2$. Two signal options have been defined, that are different only in their V_{peak} specification:

- for "option A" signals, V_{peak} shall not exceed 3,4 V (6,8 V peak-peak) (*dedicated to Ungerboeck Coded PAM*);
- for "option B" signals, V_{peak} shall not exceed 2,64 V (5,28 V peak-peak) (*dedicated to 2B1Q linecoded signals*).

The definition and measurement method of peak amplitude is specified in sub clause 13.1.

NOTE: No ETSI deliverable does specify this parameter.

10.10.3 Narrow-band signal power (NBSP)

To be compliant with this signal category, the narrow-band signal power (NBSP) into a resistive load impedance R , shall not exceed the limits given in tables 60 and 61, at any point in the frequency range 100 Hz to 30 MHz. Limits for intermediate frequencies can be found by drawing a straight line between the break points on a logarithmic (Hz) - linear (dB) scale. Table 60 describes the break points of these limits in a general way, table 61 specifies the associated parameters for all Principal frequencies between 80 kHz and 264 kHz. Figure 32 illustrates the NBSP in a bandwidth-normalized way.

The NBSP is the average power P of a sending signal into a load resistance R , within a **power** bandwidth B . The measurement method of the NBSP is described in subclause 13.2.

NOTE: No ETSI deliverable does specify this parameter.

Table 60: Break points of the narrow-band signal power P , as a function of the Principal frequency F_N of the signal category (see table 59). The parameter values for F_1 , F_2 , F_3 , $P_{1,1k}$, $P_{1,10k}$, $P_{2,10}$, SP_1 , SP_2 , are defined for each F_N in table 61

Centre frequency f	Impedance R	Signal Level P	Power bandwidth B	Spectral Power P/B
0,1 kHz	135 Ω		100 Hz	$SP_1(F_N)$
1 kHz	135 Ω		100 Hz	$SP_1(F_N)$
1 kHz	135 Ω	$P_{1,1k}(F_N)$	1 kHz	$SP_1(F_N)$
10 kHz	135 Ω	$P_{1,1k}(F_N)$	1 kHz	$SP_1(F_N)$
10 kHz	135 Ω	$P_{1,10k}(F_N)$	10 kHz	$SP_1(F_N)$
$F_1(F_N)$	135 Ω	$P_{1,10k}(F_N)$	10 kHz	$SP_1(F_N)$
$F_2(F_N)$	135 Ω	$P_{2,10k}(F_N)$	10 kHz	$SP_2(F_N)$
$F_3(F_N)$	135 Ω	-77 dBm	10 kHz	-117 dBm/Hz
$F_3(F_N)$	135 Ω	-57 dBm	1 MHz	-117 dBm/Hz
30 MHz	135 Ω	-57 dBm	1 MHz	-117 dBm/Hz

Table 61: Definition of all Principal-frequency-dependent parameters that are used in table 60, for all Principal frequencies between 80 kHz and 264 kHz

F_N [kHz]	F_1	F_2	F_3	SP_1 [dBm/Hz]	$P_{1,1k}$ [dBm]	$P_{1,10k}$ [dBm]	SP_2 [dBm/Hz]	$P_{2,1k}$ [dBm]	$P_{2,10k}$ [dBm]
$80 \leq F_N < 92$	$\frac{1}{4} \times F_N$	$\frac{3}{4} \times F_N$	$5,5 \times F_N$	-30,0	0,0	10	-38,0	-8,0	2,0
$92 \leq F_N < 104$	$\frac{1}{4} \times F_N$	$\frac{3}{4} \times F_N$	$5,5 \times F_N$	-30,5	-0,5	9,5	-38,5	-8,5	1,5
$104 \leq F_N < 116$	$\frac{1}{4} \times F_N$	$\frac{3}{4} \times F_N$	$5,5 \times F_N$	-31,0	-1,0	9,0	-39,0	-9,0	1,0
$116 \leq F_N < 129$	$\frac{1}{4} \times F_N$	$\frac{3}{4} \times F_N$	$5 \times F_N$	-31,5	-1,5	8,5	-39,5	-9,5	0,5
$129 \leq F_N < 146$	$\frac{1}{4} \times F_N$	$\frac{3}{4} \times F_N$	$5 \times F_N$	-32,0	-2,0	8,0	-40,0	-10,0	0,0
$146 \leq F_N < 164$	$\frac{1}{4} \times F_N$	$\frac{3}{4} \times F_N$	$5 \times F_N$	-32,5	-2,5	7,5	-40,5	-10,5	-0,5
$164 \leq F_N < 185$	$\frac{1}{4} \times F_N$	$\frac{3}{4} \times F_N$	$5 \times F_N$	-33,0	-3,0	7,0	-41,0	-11,0	-1,0
$185 \leq F_N < 207$	$\frac{1}{4} \times F_N$	$\frac{2}{3} \times F_N$	$4,5 \times F_N$	-33,5	-3,5	6,5	-41,5	-11,5	-1,5
$207 \leq F_N < 232$	$\frac{1}{4} \times F_N$	$\frac{2}{3} \times F_N$	$4 \times F_N$	-34,0	-4,0	6,0	-42,0	-12,0	-2,0
$232 \leq F_N < 259$	$\frac{1}{4} \times F_N$	$\frac{2}{3} \times F_N$	$3,5 \times F_N$	-34,5	-4,5	5,5	-42,5	-12,5	-2,5
$259 \leq F_N \leq 264$	$\frac{1}{4} \times F_N$	$\frac{2}{3} \times F_N$	$3,5 \times F_N$	-35,0	-5,0	5,0	-43,0	-13,0	-3,0

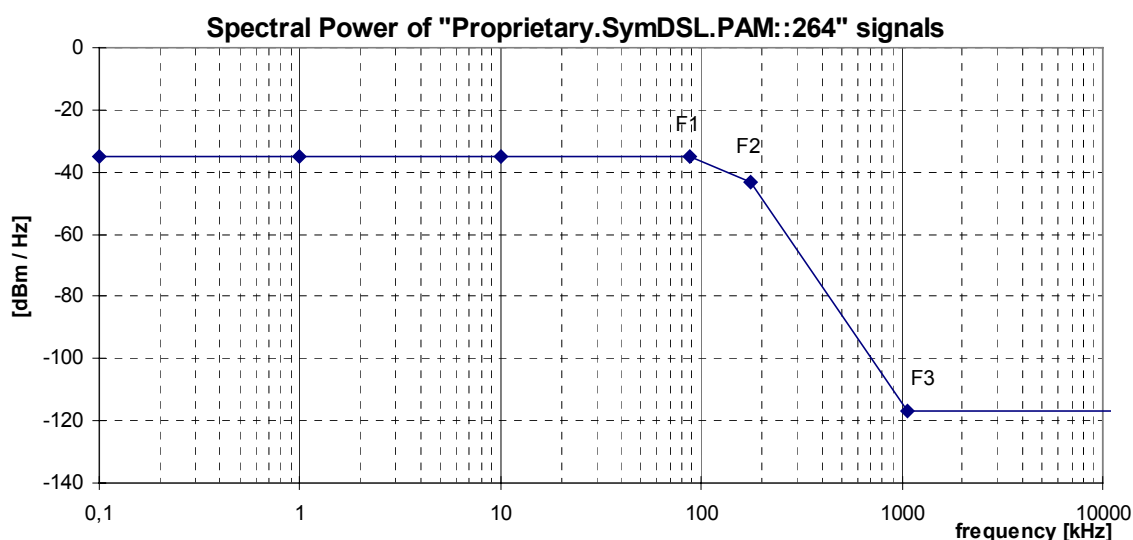

NOTE: These curves are dependent on the Principal frequency F_N , and that this figure shows an example only.

Figure 32: Spectral Power, for "Proprietary.SymDSL.PAM::264" signals (at $F_N = 264$ kHz), as specified in tables 60 and 61

10.10.4 Unbalance about earth

To be compliant with this signal category, the balance of the signal that may flow through the LT-port or NT-port shall exceed minimum requirements, under the condition that the local loop wiring and its termination is well balanced. This can be verified by a longitudinal output voltage (LOV) and a longitudinal conversion loss (LCL) measurement at the source of that signal, as specified in subclause 13.3.2 and 13.3.3. The minimum LOV and LCL requirements hold for what can be observed at the ports of the Local Loop Wiring, when the Local Loop Wiring is replaced by an artificial impedance network described in subclause 13.3.2 and 13.3.3.

The differential termination impedance for LOV and LCL measurements shall be chosen equally to the design impedance $R_T = 135 \Omega$ of the Signal Source under test.

The observed LOV shall have an rms voltage of below the value specified in table 62, measured in a power bandwidth **B**, centred over any frequency in the range from f_{\min} to f_{\max} , and averaged in any one second period. Compliance with this limitation is required with a longitudinal terminating impedance having value $Z_L(\omega)=R_L+1/(j\omega C_L)$ for all frequencies between f_{\min} to f_{\max} . Subclause 13.3.2 defines an example measurement method for longitudinal output voltage.

The observed LCL shall be higher than the lower limits given in figure 33. The LCL values of the associated break frequencies of this figure are given in table 63. Subclause 13.3.3 defines an example measurement method for longitudinal conversion loss.

NOTE: No ETSI deliverable does specify this parameter.

Table 62: Values for the LOV limits

LOV	B	f_{\min}	f_{\max}	R_L	C_L
-46 dBV	10 kHz	5,1 kHz	500 kHz	100 Ω	150 nF

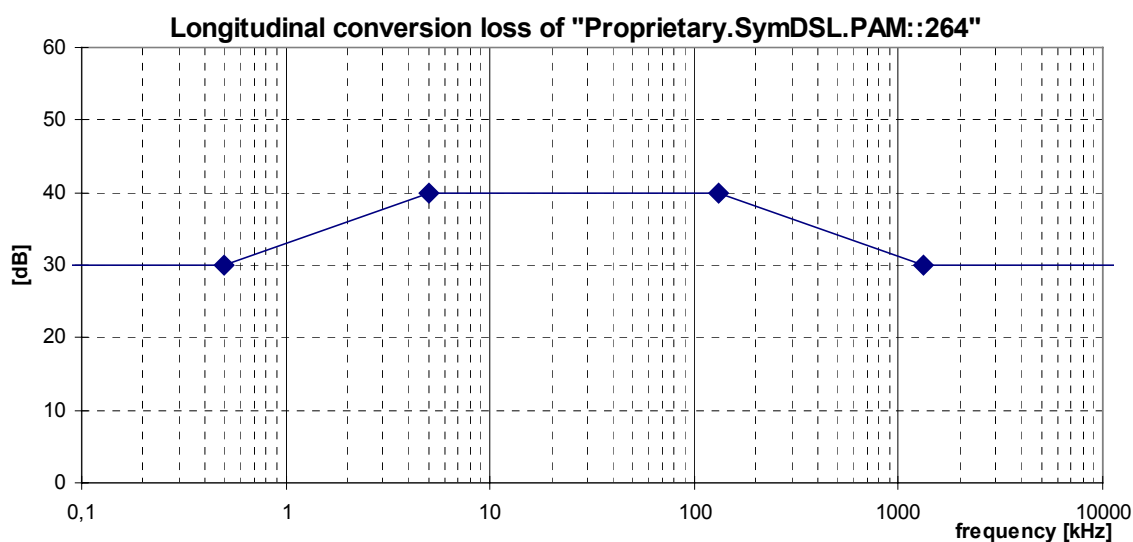

Figure 33: Minimum longitudinal conversion loss for a "Proprietary.SymDSL.PAM::264" signal source

Table 63: Frequencies and LCL values of the breakpoints of the LCL mask in figure 33

Frequency	LCL
< 0,5 kHz	slope: +20 dB/decade
5 kHz	40 dB
$\frac{1}{2} \times F_N$	40 dB
$> \frac{1}{2} \times F_N$	slope: -20 dB/decade

10.10.5 Feeding Power (from the LT-port)

Power feeding is no integral part of this signal category, although it is not uncommon for SymDSL based services. To enable power feeding in combination with this signal category, refer to one of the power feeding classes summarized in clause 7.

10.11 "Proprietary.SymDSL.2B1Q::Fn" Signals

This category covers signals, generated by Proprietary multi-rate SymDSL transmission equipment on one, two, or three wire pairs. This signal is labelled as *Proprietary*, since it is not covered by ETSI, ITU nor ANSI product standards. This signal definition is linecode independent, but dedicated to signals from transmission equipment that are using 2B1Q modulation (4-level PAM). The use of other line codes is not precluded.

In the naming convention " Proprietary.SymDSL.2B1Q::Fn", is the phrase "Fn" a placeholder for a number that is used as parameter F_N in the signal definition. Replacing "Fn" in the signal name by a value, changes the generic signal description into a specific description, since its value is required in the subclauses below. It is referred to as the *Principal frequency* of the signal.

The Principal frequency F_N is indicative for the maximum symbol rate [kbaud] that can be transported within these signal limits. A signal with a higher Principal Frequency occupies a wider spectrum. The subclause below are defined for all Principal frequencies between 32 kHz and 1 160 kHz.

Table 64 gives several examples on how to use the naming convention for specifying the actual parameter value F_n . It also illustrates some (informative) bit rates that can be transported within these signal limits, when using the associated (informative) modulation parameters. These are examples only, other system implementations may use the same signal limits in a different way.

Table 64: Naming convention for parameter F_N

Signal category	F_N [kHz]		Symbol Rate [kbaud]	Bit/symbol	Bit Rate [kb/s]
Proprietary.SymDSL.2B1Q::80	80		80	2	160
Proprietary.SymDSL.2B1Q::1160	1 160		1 160	2	2 320
NOTE: Example on how the naming convention relates to the actual parameter value F_N that is used in the subclauses below to specify the signal limits of this signal category. The actual bitrates and modulation parameters are implementation dependent, and informative only.					

10.11.1 Total Signal Power

To be compliant with this signal category, the mean signal power into a resistive load of 135 Ω shall not exceed a level of 14 dBm, measured within a frequency band from at least 100 Hz to $2 \times F_N$.

NOTE: No ETSI deliverable does specify this parameter.

10.11.2 Peak amplitude

To be compliant with this signal category, the nominal voltage peak of the largest signal pulse into a resistive load of 135 Ω shall not exceed a level of $V_{\text{peak}} = 5 \text{ V} (\pm 7 \%)$, measured within a frequency band from at least 100 Hz to $F_N \times 2$. The definition and measurement method of peak amplitude is specified in sub clause 13.1.

NOTE: No ETSI deliverable does specify this parameter.

10.11.3 Narrow-band signal power (NBSP)

To be compliant with this signal category, the narrow-band signal power (NBSP) into a resistive load impedance R , shall not exceed the limits given in table 66, at any point in the frequency range 100 Hz to 30 MHz. Limits for intermediate frequencies can be found by drawing a straight line between the break points on a logarithmic (Hz) - linear (dB) scale. Table 60 describes the break points of these limits for all Principal frequencies between 32 and 1 160 kHz. Figure 34 illustrates the NBSP in a bandwidth-normalized way.

The NBSP is the average power P of a sending signal into a load resistance R , within a **power** bandwidth B . The measurement method of the NBSP is described in subclause 13.2.

NOTE: No ETSI deliverable does specify this parameter.

Table 65: Break points of the narrow-band signal power P, as a function of the Principal frequency F_N of the signal category

frequency f	Impedance R	Signal Level P [dBm]	Noise Bandwidth B	Spectral Power P/B [dBm/Hz]
0,1 kHz	135 Ω	$P_0 + 3,5 + 20$	100 Hz	$P_0 + 3,5$
1 kHz	135 Ω	$P_0 + 3,5 + 20$	100 Hz	$P_0 + 3,5$
1 kHz	135 Ω	$P_0 + 3,5 + 30$	1 kHz	$P_0 + 3,5$
10 kHz	135 Ω	$P_0 + 3,5 + 30$	1 kHz	$P_0 + 3,5$
10 kHz	135 Ω	$P_0 + 3,5 + 40$	10 kHz	$P_0 + 3,5$
$0,2 \times F_N$	135 Ω	$P_0 + 3,5 + 40$	10 kHz	$P_0 + 3,5$
$0,5 \times F_N$	135 Ω	$P_0 + 1,0 + 40$	10 kHz	$P_0 + 1,0$
$0,75 \times F_N$	135 Ω	$P_0 - 9,5 + 40$	10 kHz	$P_0 - 9,5$
$1 \times F_N$	135 Ω	$P_0 - 31,5 + 40$	10 kHz	$P_0 - 31,5$
$1,5 \times F_N$	135 Ω	$P_0 - 35 + 40$	10 kHz	$P_0 - 35$
$3,5 \times F_N$	135 Ω	$P_0 - 72,5 + 40$	10 kHz	$P_0 - 72,5$
$6 \times F_N$	135 Ω	-70	10 kHz	-110
$6 \times F_N$	135 Ω	-50	1 MHz	-110
30 MHz	135 Ω	-50	1 MHz	-110

The reference power level, P_0 , in table 65 is given by the formula below. Its value has been evaluated for a few sample Principal frequencies.

$$P_0 = 10 \log_{10} \left(\frac{2.65^2}{135} \times \frac{1 \text{ kHz}}{F_N} \right)$$

Table 66: Reference power levels, as a function of the Principle frequency

F_N	80	264	520	1 160	kHz
P_0	-31,87	-37,05	-40	-43,48	dBm/Hz
NOTE: The table summarizes some sample values, calculated from this formula.					

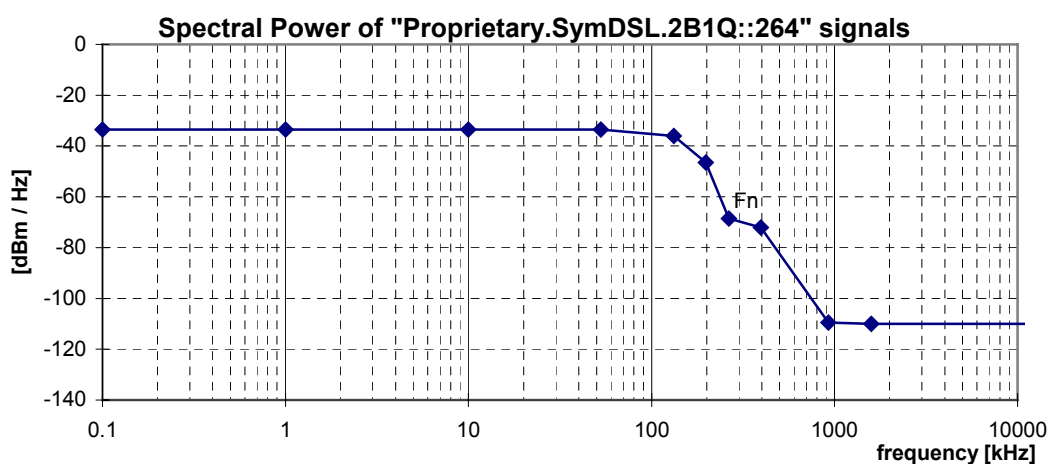

NOTE: These curves are dependent on the Principal frequency F_N , and that this figure shows an example only.

Figure 34: Spectral Power, for "Proprietary.SymDSL.2B1Q::264" signals (at $F_N=264$ kHz), as specified in table 60

10.11.4 Unbalance about earth

To be compliant with this signal category, the balance of the signal that may flow through the LT-port or NT-port shall exceed minimum requirements, under the condition that the local loop wiring and its termination is well balanced. This can be verified by a longitudinal output voltage (LOV) and a longitudinal conversion loss (LCL) measurement at the source of that signal, as specified in subclause 13.3.2 and 13.3.3. The minimum LOV and LCL requirements hold for what can be observed at the ports of the Local Loop Wiring, when the Local Loop Wiring is replaced by an artificial impedance network described in subclause 13.3.2 and 13.3.3.

The differential termination impedance for LOV and LCL measurements shall be chosen equally to the design impedance $R_T = 135 \Omega$ of the Signal Source under test.

The observed LOV shall have an rms voltage of below the value specified in table 67, measured in a power bandwidth B , centred over any frequency in the range from f_{\min} to f_{\max} , and averaged in any one second period. Compliance with this limitation is required with a longitudinal terminating impedance having value $Z_L(\omega) = R_L + 1/(j\omega C_L)$ for all frequencies between f_{\min} to f_{\max} . Subclause 13.3.2 defines an example measurement method for longitudinal output voltage.

The observed LCL shall be higher than the lower limits given in figure 35. The LCL values of the associated break frequencies of this figure are given in table 68. Subclause 13.3.3 defines an example measurement method for longitudinal conversion loss.

NOTE: No ETSI deliverable does specify this parameter.

Table 67: Values for the LOV limits

LOV	B	f_{\min}	f_{\max}	R_L	C_L
-50 dBV	4 kHz	100 kHz	400 kHz	100 Ω	150 nF

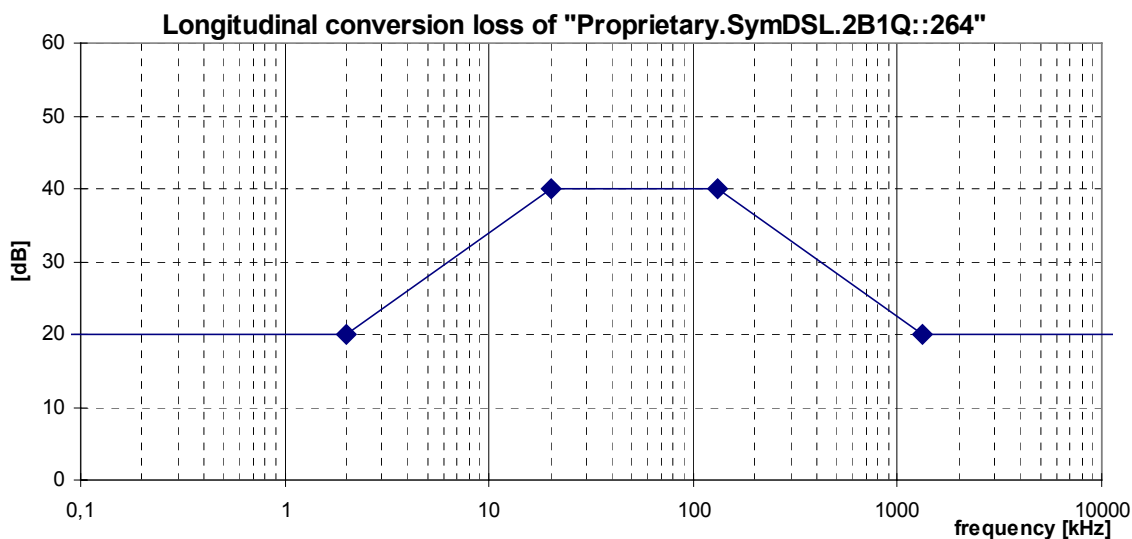

Figure 35: Minimum longitudinal conversion loss for a "Proprietary.SymDSL.2B1Q::264" signal source

Table 68: Frequencies and LCL values of the breakpoints of the LCL mask in figure 35

Frequency	LCL
<2 kHz	20 dB
2 kHz	20 dB
20 kHz	40 dB
$\frac{1}{2} \times F_N$	40 dB
$5 \times F_N$	20 dB
30 MHz	20 dB

10.11.5 Feeding Power (from the LT-port)

Power feeding is no integral part of this signal category, although it is not uncommon for SymDSL services. To enable power feeding in combination with this signal category, refer to one of the power feeding classes summarized in clause 7.

10.12 "Proprietary.PCM.HDB3.2M.SR" Signals

This category covers signals generated by 2 Mbit/s transmission equipment on two wire-pairs, usable for instance for ISDN-Primary Rate Access. This category include HDB3 line coding and sine shaped transmit pulses in case of sending a randomized bit sequence. This signal is labelled as *proprietary*, since it is not covered by ETSI, ITU nor ANSI product standards.

A signal can be classified as an "Proprietary.PCM.HDB3.2M.SR" signal if it is compliant with all subclauses below.

NOTE: The signals covered here are only applicable to systems wick are using *sine shaped transmit pulses* and in case of *sending a randomized bit sequence*. Special bit sequences like AIS (Alarm Indication Signal) or others and other transmit pulse forms than described here can cause different signals. The way these characteristics are to be covered by specifications, are for further study.

10.12.1 Total signal power

To be compliant with this signal category, the mean signal power into a resistive load of 130 Ω shall not exceed a level of 11 dBm ($\pm 0,5$ dBm), measured within a frequency band from at least 100 Hz to 20 MHz.

NOTE: No ETSI deliverable does specify this parameter.

10.12.2 Peak amplitude

To be compliant with this signal category, the nominal voltage peak of the largest signal pulse into a resistive load of 130 Ω shall not exceed a level of 2,36 V (± 10 %), measured within a frequency band from at least 100 Hz to 20 MHz. The definition and measurement method of peak amplitude is specified in sub clause 13.1.

NOTE: No ETSI deliverable does specify this parameter.

10.12.3 Narrow-band signal power

To be compliant with this signal category, the narrow-band signal power (NBSP) into a resistive load impedance R , shall not exceed the limits given in table 69, at any point in the frequency range 100 Hz to 30 MHz. This table specifies the break points of these limits. Limits for intermediate frequencies can be found by drawing a straight line between the break points on a logarithmic (Hz) - linear (dB) scale. Figure 36 illustrates the NBSP in a bandwidth-normalized way.

The NBSP is the average power P of a sending signal into a load resistance R , within a *power* bandwidth B . The measurement method of the NBSP is described in subclause 13.2.

NOTE: No ETSI deliverable does specify this parameter.

Table 69: Break points of the narrow-band power limits

Centre frequency f	Impedance R	Signal Level P	Power bandwidth B	Spectral Power P/B
0,51 kHz	130 Ω	-49,8 dBm	100 Hz	-69,8 dBm/Hz
10 kHz	130 Ω	-42 dBm	100 Hz	-62 dBm/Hz
10 kHz	130 Ω	-22 dBm	10 kHz	-62 dBm/Hz
1 MHz	130 Ω	-10 dBm	10 kHz	-50 dBm/Hz
20 MHz	130 Ω	-59 dBm	10 kHz	-99 dBm/Hz
>20 MHz	130 Ω	-80 dBm	10 kHz	-120 dBm/Hz
20 MHz	130 Ω	-60 dBm	1 MHz	-120 dBm/Hz
30 MHz	130 Ω	-60 dBm	1 MHz	-120 dBm/Hz

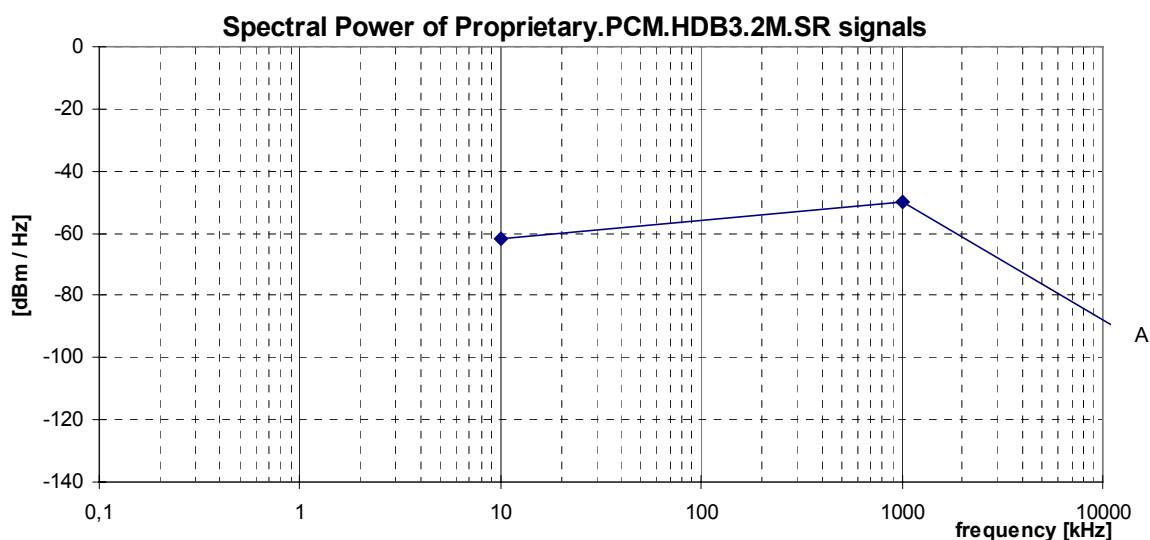

Figure 36: Spectral Power, for Proprietary.PCM.HDB3.2M.SR signals, as specified in table 69

10.12.4 Unbalance about earth

To be compliant with this signal category, the balance of the signal that may flow through the LT-port or NT-port shall exceed minimum requirements, under the condition that the local loop wiring and its termination is well balanced. This can be verified by a longitudinal output voltage (LOV) and a longitudinal conversion loss (LCL) measurement at the source of that signal, as specified in subclause 13.3.2 and 13.3.3. The minimum LOV and LCL requirements hold for what can be observed at the ports of the Local Loop Wiring, when the Local Loop Wiring is replaced by an artificial impedance network described in subclause 13.3.2 and 13.3.3.

The differential termination impedance for LOV and LCL measurements shall be chosen equally to the design impedance $R_T = 135 \Omega$ of the Signal Source under test.

The observed LOV shall have an rms voltage of below the value specified in table 70, measured in a power bandwidth **B**, centred over any frequency in the range from f_{\min} to f_{\max} , and averaged in any one second period. Compliance with this limitation is required with a longitudinal terminating impedance having value $Z_L(\omega)=R_L+1/(j\omega C_L)$ for all frequencies between f_{\min} to f_{\max} . Subclause 13.3.2 defines an example measurement method for longitudinal output voltage.

The observed LCL shall be higher than the lower limits given in figure 71. The LCL values of the associated break frequencies of this figure are given in table 71. Subclause 13.3.3 defines an example measurement method for longitudinal conversion loss.

NOTE: No ETSI deliverable does specify this parameter.

Table 70: Values for the LOV limits

LOV	B	f_{\min}	f_{\max}	R_L	C_L
-46 dBV	10 kHz	5,1 kHz	2,15 MHz	100 Ω	150 nF

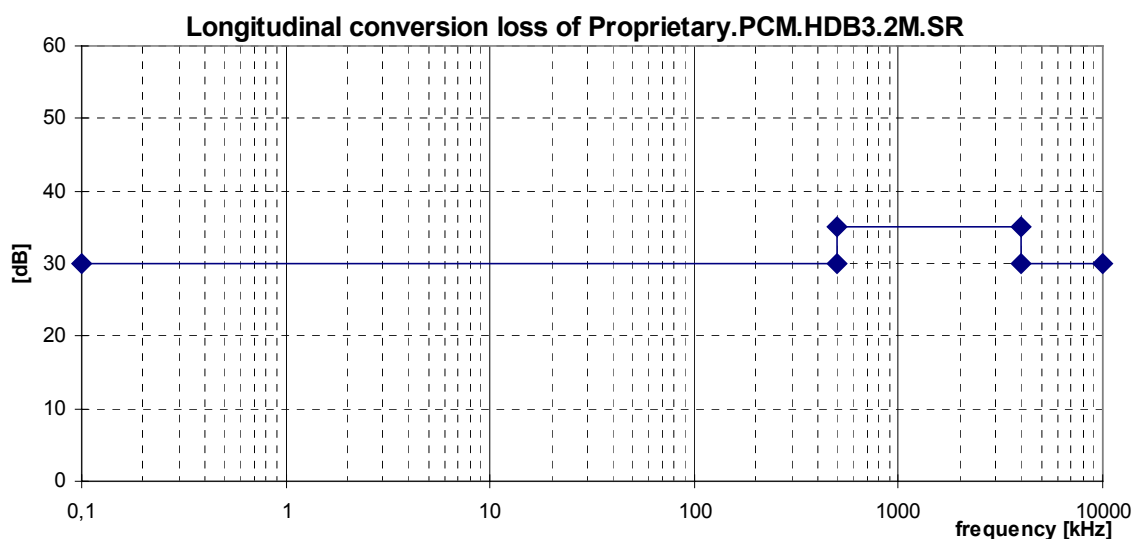

Figure 37: Minimum longitudinal conversion loss for a "Proprietary.PCM.HDB3.2M.SR" signal source

Table 71: Frequencies and LCL values of the breakpoints of the LCL mask in figure 37

Frequency range	LCL
< 500 kHz	30 dB
500 kHz	35 dB
1 000 kHz	35 dB
4 000 kHz	35 dB
30 MHz	30 dB

10.12.5 Feeding Power (from the LT-port)

Power feeding is no integral part of this signal category, although it is not uncommon for PCM.HDB3 services. To enable power feeding in combination with this signal category, refer to one of the power feeding classes summarized in clause 7.

10.13 "Proprietary.PCM.HDB3.2M.SQ" Signals

This category covers signals generated by 2 Mbit/s transmission equipment on two wire-pairs, usable for instance for ISDN-Primary Rate Access. This category include HDB3 line coding and square shaped transmit pulses in case of sending a randomized bit sequence. This signal is labelled as *proprietary*, since it is not covered by ETSI, ITU nor ANSI product standards.

A signal can be classified as an "Proprietary.PCM.HDB3.2M.SQ" signal if it is compliant with all subclauses below.

NOTE: The signals covered here are only applicable to systems wich are using *square shaped transmit pulses* and in case of *sending a randomized bit sequence*. Special bit sequences like AIS (Alarm Indication Signal) or others and other transmit pulse forms than described here can cause different signals. The way these characteristics are to be covered by specifications, are for further study.

10.13.1 Total signal power

To be compliant with this signal category, the mean signal power into a resistive load of 120 Ω shall not exceed a level of 13 dBm, measured within a frequency band from 100 Hz to 30 MHz.

NOTE: No ETSI deliverable does specify this parameter.

10.13.2 Peak amplitude

To be compliant with this signal category, the nominal peak amplitude of the largest signal into a resistive load of 120 Ω shall not exceed a level of 3.0V +/- 5%. The definition and measurement method of peak amplitude is specified in sub clause 13.1.

NOTE: No ETSI deliverable does specify this parameter.

10.13.3 Narrow band signal power

To be compliant with this signal category, the narrow-band signal power (NBSP) into a resistive load impedance **R**, shall not exceed the limits given in table 72, at any point in the frequency range 100 Hz to 30 MHz. This table specifies the break points of these limits. Limits for intermediate frequencies can be found by drawing a straight line between the break points on a logarithmic (Hz) - linear (dB) scale. Figure 38 illustrates the NBSP in a bandwidth-normalized way.

The NBSP is the average power **P** of a sending signal into a load resistance **R**, within a *power* bandwidth **B**. The measurement method of the NBSP is described in subclause 13.2.

NOTE: No ETSI deliverable does specify this parameter.

Table 72: Break points of the narrow-band power limits

Centre frequency f	Impedance R	Signal Level P	Power bandwidth B	Spectral Power P/B	
10 kHz	120 Ω	-40 dBm	100 Hz	-60 dBm/Hz	A
10 kHz	120 Ω	-20 dBm	10 kHz	-60 dBm/Hz	
100 kHz	120 Ω	-18 dBm	10 kHz	-58 dBm/Hz	
700 kHz	120 Ω	-7 dBm	10 kHz	-47 dBm/Hz	
1200 kHz	120 Ω	-8 dBm	10 kHz	-48 dBm/Hz	
2 MHz	120 Ω	-14 dBm	10 kHz	-54 dBm/Hz	
20 MHz	120 Ω	-46 dBm	10 kHz	-86 dBm/Hz	
>20 MHz	120 Ω	-55 dBm	10 kHz	-95 dBm/Hz	
20 MHz	120 Ω	-26 dBm	1 MHz	-86 dBm/Hz	B
30 MHz	120 Ω	-35 dBm	1 MHz	-95 dBm/Hz	

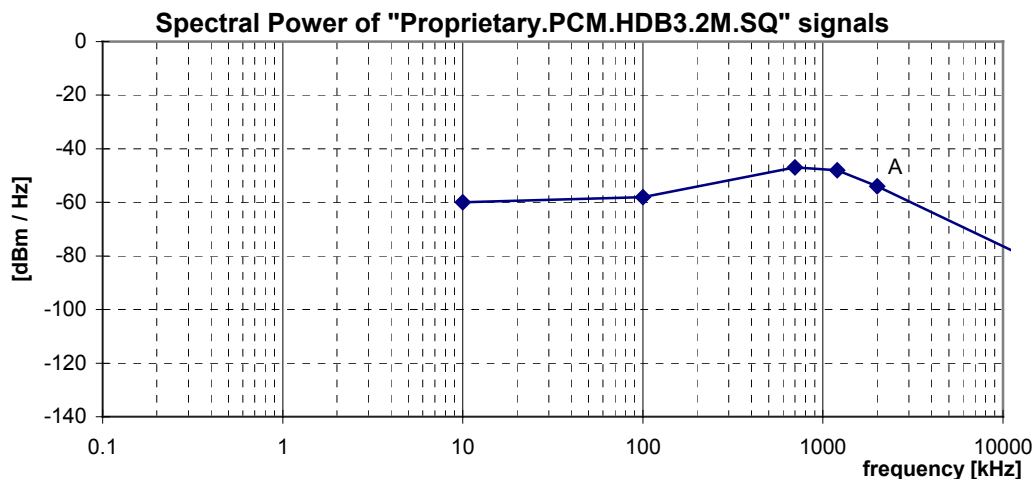

Figure 38: Spectral Power, for Proprietary.PCM.HDB3.2M.SQ signals, as specified in table 72

10.13.4 Unbalance about earth

To be compliant with this signal category, the LCL shall be better than 35dB at 1024kHz..

NOTE: No ETSI deliverable does specify this parameter.

11 Cluster 4 Signals (asymmetrical broad band)

This cluster summarizes asymmetrical signals that are generated by digital transmission equipment up to 8 Mb/s, including ADSL. Asymmetrically means a bit rate in the downstream direction and a significantly lower bitrate (e.g. 25 %) in the upstream direction.

NOTE: Asymmetrical DSL systems generate different signals in different transmission directions. Reversal of their transmission direction, which means the injection of upstream signals into LT-ports and downstream signals into the NT-ports, will cause a substantial reduction of the maximum reach. Such a reduction is even significant for all asymmetrical DSL systems when only one such system is reversed. Therefore the classification of asymmetrical DSL systems is consequently split into upstream and downstream specifications.

11.1 "ADSL over POTS" Signals

This category covers signals, generated by ADSL transmission equipment. These signals may share the same wire pair with POTS signals.

Figure 1 Spectral power for ISDN PRA with square shaped pulses.

This clause is based on ETSI, ANSI and ITU reports on ADSL equipment [18], [19] and [21]. A signal can be classified as an "ADSL over POTS" signal if it is compliant with all subclauses below.

11.1.1 Total signal power (downstream only)

To be compliant with this signal category, the mean downstream signal power into a resistive load of 100 Ω shall not exceed a level of 20,4 dBm, measured within a frequency band from at least 4 kHz to 3 MHz.

If measurements of the upstream power indicates that downstream power back-off is necessary, as described for the downstream PSD, than the maximum total transmit power shall be reduced accordingly.

Reference: ANSI-T1.413, issue 2 [20], subclauses 6.15.1 and 6.15.3.

Reference: ITU-T Recommendation G.992.1 [21], subclause A.1.2.3.1.

11.1.2 Total signal power (upstream only)

To be compliant with this signal category, the mean upstream signal power into a resistive load of 100 Ω shall not exceed a level of 12,5 dBm, measured within a frequency band from at least 4 kHz to 3 MHz.

Reference: ANSI-T1.413, issue 2 [20], subclauses 7.15.1 and 7.15.3.

Reference: ITU-T Recommendation G.992.1 [21], subclause A.2.4.3.1.

11.1.3 Peak amplitude (upstream and downstream)

To be compliant with this signal category, the nominal voltage peak of the largest signal pulse into a resistive load of 100 Ω shall not exceed a level of 7,5 V (14 V peak-peak), measured within a frequency band from at least 100 Hz to 1 MHz. The definition and measurement method of peak amplitude is specified in sub clause 13.1.

NOTE: No ETSI deliverable does specify this parameter.

11.1.4 Narrow-band signal power (downstream only)

To be compliant with this signal category, the narrow-band signal power (NBSP) into a resistive load impedance R , shall not exceed the limits given in table 73, at any point in the frequency range 100 Hz to 30 MHz. This table specifies the break points of these limits. Limits for intermediate frequencies can be found by drawing a straight line between the break points on a logarithmic (Hz) - linear (dB) scale. Figure 39 illustrates the NBSP in a bandwidth-normalized way.

The NBSP is the average power P of a sending signal into a load resistance R , within a *power* bandwidth B . The measurement method of the NBSP is described in subclause 13.2.

NOTE: The NBSP specification in table 73 is reconstructed from the commonly used PSD specifications in [18], [19] and [21] (similar to figure 39), and used here since it is much wider applicable. This enables a unified specification method. PSD specifications are adequate when signals are purely random in nature, but cannot cover harmonic components in a signal (would cause infinite high "PSD" levels at these harmonic frequencies). NBSP specifications cover both signal types.

The NBSP specification of this signal category has been split into two overlapping limits. Both upper limits shall hold simultaneously. The 10 kHz bandwidth values represent the "maximum PSD values" from [18], [19] and [21], and includes the pass band ripple. The 100 kHz bandwidth values represent the "average PSD values" in the passband to smooth out the spectral ripple of 3,5 dB. The 1 MHz bandwidth specification is equivalent to the "sliding window" specification in [18], [19] and [21].

Reference: ANSI-T1.413, issue 2 [20], subclause 6.14, reconstructed from PSD requirements.

Reference: ITU-T Recommendation G.992.1 [21], subclause A.1.2 reconstructed from PSD requirements.

Table 73: Break points of the narrow-band power limits. The values for parameter P_{BO} are defined in table 74, and are dependent from the received upstream power (Power back-off)

Centre frequency f	Impedance R	Signal Level P	Power bandwidth B	Spectral Power P/B	
0,1 kHz	600 Ω	-77,5 dBm	100 Hz	-97,5 dBm/Hz	A
1 kHz	600 Ω	-77,5 dBm	100 Hz	-97,5 dBm/Hz	
1 kHz	600 Ω	-67,5 dBm	1 kHz	-97,5 dBm/Hz	
4 kHz	600 Ω	-67,5 dBm	1 kHz	-97,5 dBm/Hz	
4 kHz	100 Ω	-52,5 dBm	10 kHz	-92,5 dBm/Hz	
25,875 kHz	100 Ω	+3,5 dBm	10 kHz	-36,5 dBm/Hz	
1 104 kHz	100 Ω	+3,5 dBm	10 kHz	-36,5 dBm/Hz	
3 093 kHz	100 Ω	-50 dBm	10 kHz	-90 dBm/Hz	
11 040 kHz	100 Ω	-50 dBm	10 kHz	-90 dBm/Hz	B
30 000 kHz	100 Ω	-50 dBm	10 kHz	-90 dBm/Hz	
60 kHz	100 Ω	$P_{RO} + 50$ dBm	100 kHz	P_{RO} dBm/Hz	
1 104 kHz	100 Ω	$P_{RO} + 50$ dBm	100 kHz	P_{RO} dBm/Hz	
3 093 kHz	100 Ω	-40 dBm	100 kHz	-90 dBm/Hz	
3 093 kHz	100 Ω	-30 dBm	1 MHz	-90 dBm/Hz	
4 545 kHz	100 Ω	-50 dBm	1 MHz	-110 dBm/Hz	
30 000 kHz	100 Ω	-50 dBm	1 MHz	-110 dBm/Hz	

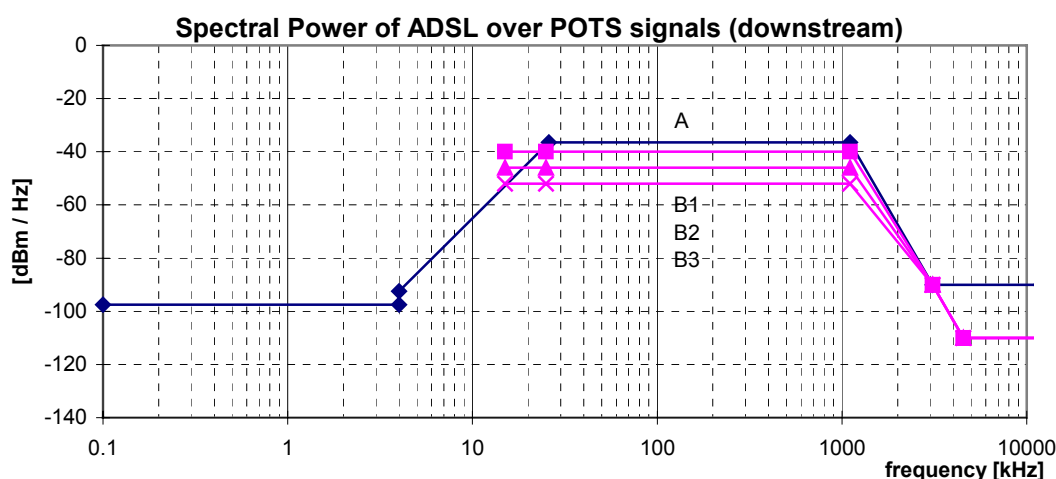

Figure 39: Spectral Power, for ADSL over POTS signals, as specified in table 73. The maximum spectral power varies with the value of parameter P_{BO} , as defined in table 74. Only the curves for the values $P_{BO}=-40$ dBm/Hz, $P_{BO}=-46$ dBm/Hz, and $P_{BO}=-52$ dBm/Hz are shown here

Power back-off. To be compliant with this signal category, the maximum downstream signal power shall be reduced when the received upstream power is above specified levels. If the total received upstream power from 28,031 kHz to 79,781 kHz (ADSL sub-carriers 7-18) is greater than 3 dBm into 100 Ω then parameter P_{BO} shall not exceed the values shown in table 74. The received upstream power measurement shall be performed with an accuracy of ± 1 dB or better.

Reference: ANSI-T1.413, issue 2 [20], subclause 9.4.6.

Reference: ITU-T Recommendation G.992.1 [21], subclause A.3.1.

Table 74: Definition of parameter P_{BO} , as used in table 73 (Power Back-off, or Power Cut-Back)

Upstream received power [dBm]	< 3	< 4	< 5	< 6	< 7	< 8	< 9
Parameter P_{BO} [dBm/Hz]	-40	-42	-44	-46	-48	-50	-52

11.1.5 Narrow-band signal power (upstream only)

To be compliant with this signal category, the narrow-band signal power (NBSP) into a resistive load impedance R , shall not exceed the limits given in table 75, at any point in the frequency range 100 Hz to 30 MHz. This table specifies the break points of these limits. Limits for intermediate frequencies can be found by drawing a straight line between the break points on a logarithmic (Hz) - linear (dB) scale. Figure 40 illustrates the NBSP in a bandwidth-normalized way.

The NBSP is the average power P of a sending signal into a load resistance R , within a **power** bandwidth B . The measurement method of the NBSP is described in subclause 13.2.

NOTE: The NBSP specification in table 73 is reconstructed from the commonly used PSD specifications in [18], [19] and [21] (similar to figure 40), and used here since it is much wider applicable. This enables a unified specification method. PSD specifications are adequate when signals are purely random in nature, but cannot cover harmonic components in a signal (would cause infinite high "PSD" levels at these harmonic frequencies). NBSP specifications cover both signal types.

The NBSP specification of this signal category has been split into two overlapping limits. Both upper limits shall hold simultaneously. The 10 kHz bandwidth values represent the "maximum PSD values" from [18], [19] and [21], and includes the pass band ripple. The 100 kHz bandwidth values represent the "average PSD values" in the passband to smooth out the spectral ripple of 3,5 dB. The 1 MHz bandwidth specification is equivalent to the "sliding window" specification in [18], [19] and [21].

Reference: ANSI-T1.413, issue 2 [20], subclause 7.14 reconstructed from PSD requirements.

Reference: ITU-T Recommendation G.992.1 [21], subclause A.2.4 reconstructed from PSD requirements.

Table 75: Break points of the narrow-band power limits

Centre frequency f	Impedance R	Signal Level P	Power bandwidth B	Spectral Power P/B	
0,1 kHz	600 Ω	-77,5 dBm	100 Hz	-97,5 dBm/Hz	A
1 kHz	600 Ω	-77,5 dBm	100 Hz	-97,5 dBm/Hz	
1 kHz	600 Ω	-67,5 dBm	1 kHz	-97,5 dBm/Hz	
4 kHz	600 Ω	-67,5 dBm	1 kHz	-97,5 dBm/Hz	
4 kHz	100 Ω	-52,5 dBm	10 kHz	-92,5 dBm/Hz	
25,875 kHz	100 Ω	+5,5 dBm	10 kHz	-34,5 dBm/Hz	
138 kHz	100 Ω	+5,5 dBm	10 kHz	-34,5 dBm/Hz	
307 kHz	100 Ω	-50 dBm	10 kHz	-90 dBm/Hz	
11 040 kHz	100 Ω	-50 dBm	10 kHz	-90 dBm/Hz	B
30 000 kHz	100 Ω	-50 dBm	10 kHz	-90 dBm/Hz	
60 kHz	100 Ω	+12 dBm	100 kHz	-38 dBm/Hz	
138 kHz	100 Ω	+12 dBm	100 kHz	-38 dBm/Hz	
307 kHz	100 Ω	-40 dBm	100 kHz	-90 dBm/Hz	
1 221 kHz	100 Ω	-40 dBm	100 kHz	-90 dBm/Hz	
1 221 kHz	100 Ω	-30 dBm	1 MHz	-90 dBm/Hz	
1 630 kHz	100 Ω	-50 dBm	1 MHz	-110 dBm/Hz	
11 040 kHz	100 Ω	-50 dBm	1 MHz	-110 dBm/Hz	
30 000 kHz	100 Ω	-50 dBm	1 MHz	-110 dBm/Hz	

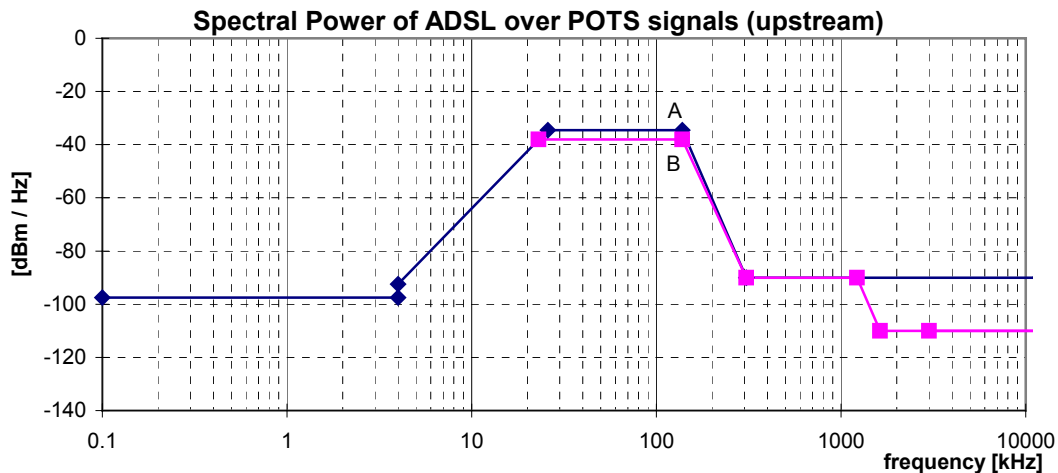

Figure 40: Spectral Power, for ADSL over POTS signals, as specified in table 75

11.1.6 Unbalance about earth (upstream and downstream)

To be compliant with this signal category, the balance of the signal that may flow through the LT-port or NT-port shall exceed minimum requirements, under the condition that the local loop wiring and its termination is well balanced. This can be verified by a longitudinal output voltage (LOV) and a longitudinal conversion loss (LCL) measurement at the source of that signal, as specified in subclause 13.3.2 and 13.3.3. The minimum LOV and LCL requirements hold for what can be observed at the ports of the Local Loop Wiring, when the Local Loop Wiring is replaced by an artificial impedance network described in subclause 13.3.2 and 13.3.3.

The differential termination impedance for LOV and LCL measurements shall be chosen equally to the design impedance $R_T = 100 \Omega$ of the Signal Source under test.

The observed LOV shall have an rms voltage of below the value specified in table 76, measured in a power bandwidth **B**, centred over any frequency in the range from f_{\min} to f_{\max} , and averaged in any one second period. Compliance with this limitation is required with a longitudinal terminating impedance having value $Z_L(\omega) = R_L + 1/(j\omega C_L)$ for all frequencies between f_{\min} to f_{\max} . Subclause 13.3.2 defines an example measurement method for longitudinal output voltage.

The observed LCL shall be higher than the lower limits given in figure 41. The LCL values of the associated break frequencies of this figure are given in table 77. Subclause 13.3.3 defines an example measurement method for longitudinal conversion loss. To be compliant with this signal category, this requirement shall be met for both the switched-on and switched-off mode of the signal source.

Reference: ANSI-T1.413 issue 2 [20], subclause 12.3.1 extended to 30 MHz according to [23].

Reference: TS 101 270-1 [23], subclauses 8.3.3 and E.3.2.

Table 76: Values for the LOV limits

	LOV	B	f_{\min}	f_{\max}	R_L	C_L
downstream	-46 dBV	10 kHz	5,1 kHz	1 825 kHz	100 Ω	150 nF
upstream	-46 dBV	10 kHz	5,1 kHz	210 kHz	100 Ω	150 nF

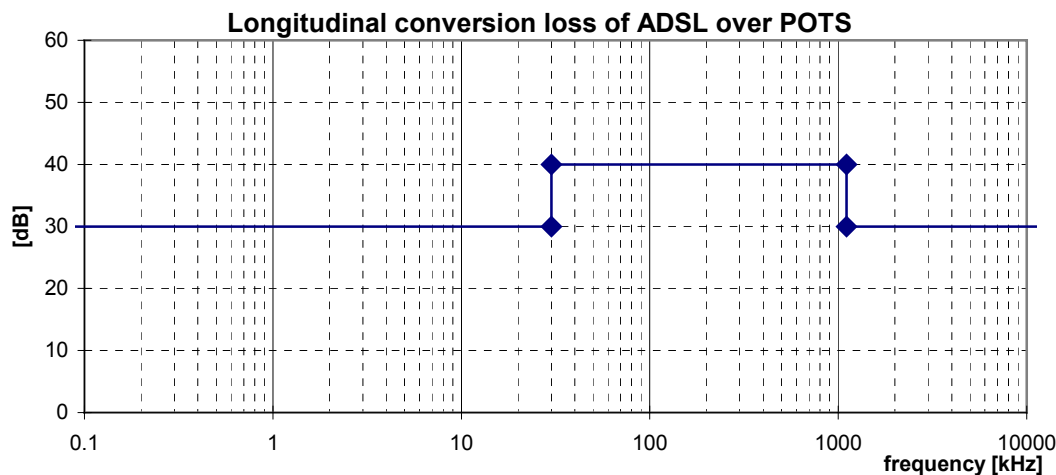

Figure 41: Minimum longitudinal conversion loss

Table 77: Frequencies and LCL values of the breakpoints of the LCL mask in figure 41

Frequency	LCL
< 30 kHz	30 dB
30 kHz	40 dB
1 104 kHz	40 dB
> 1 104 kHz	30 dB

11.2 "ADSL over ISDN" Signals

This category covers signals, generated by ADSL transmission equipment. These signals may share the same wire pair with ISDN signals.

This clause is based on ETSI and ITU reports on ADSL equipment [18] and [21]. A signal can be classified as an "ADSL over ISDN" signal if it is compliant with all subclauses below.

11.2.1 Total signal power (downstream only)

To be compliant with this signal category, the mean downstream signal power into a resistive load of 100 Ω shall not exceed a level of 19,83 dBm, measured within a frequency band from at least 4 kHz to 3 MHz.

If measurements of the upstream power indicates that downstream power back-off is necessary, as described for the downstream PSD, than the maximum total transmit power shall be reduced accordingly.

Reference: TS 101 388 [18], subclause 5.2.

11.2.2 Total signal power (upstream only)

To be compliant with this signal category, the mean upstream signal power into a resistive load of 100 Ω shall not exceed a level of 13,26 dBm, measured within a frequency band from at least 4 kHz to 3 MHz.

Reference: TS 101 388 [18], subclause 6.3.

11.2.3 Peak amplitude (upstream and downstream)

To be compliant with this signal category, the nominal voltage peak of the largest signal pulse into a resistive load of 100 Ω shall not exceed a level of 7,5V (14V peak-peak), measured within a frequency band from at least 100 Hz to 1 MHz. The definition and measurement method of peak amplitude is specified in sub clause 13.1.

NOTE: No ETSI deliverable does specify this parameter.

11.2.4 Narrow-band signal power (downstream only)

To be compliant with this signal category, the narrow-band signal power (NBSP) into a resistive load impedance R , shall not exceed the limits given in table 78, at any point in the frequency range 100 Hz to 30 MHz. This table specifies the break points of these limits. Limits for intermediate frequencies can be found by drawing a straight line between the break points on a logarithmic (Hz) - linear (dB) scale. Figure 42 illustrates the NBSP in a bandwidth-normalized way.

The NBSP is the average power P of a sending signal into a load resistance R , within a *power* bandwidth B . The measurement method of the NBSP is described in subclause 13.2.

Reference: TS 101 388 [18], subclause 5.4, reconstructed from PSD requirements.

Reference: ITU-G992.1 [21], subclause B.1.3, reconstructed from PSD requirements.

NOTE: The NBSP specification in table 78 is reconstructed from the commonly used PSD specifications in [18] and [21] (similar to figure 42), and used here since it is much wider applicable. This enables a unified specification method. PSD specifications are adequate when signals are purely random in nature, but cannot cover harmonic components in a signal (would cause infinite high "PSD" levels at these harmonic frequencies). NBSP specifications cover both signal types.

The NBSP specification of this signal category has been split into two overlapping limits. Both upper limits shall hold simultaneously. The 10 kHz bandwidth values represent the "maximum PSD values" from [18] and [21], and includes the pass band ripple. The 100 kHz bandwidth values represent the "average PSD values" in the passband to smooth out the spectral ripple of 3,5 dB. The 1 MHz bandwidth specification is equivalent to the "sliding window" specification in [18] and [21].

Table 78: Break points of the narrow-band power limits. The values for parameter P_{BO} are defined in table 79, and are dependent from the received upstream power (Power back-off)

Centre Frequency f	Impedance R	Signal Level P	Power bandwidth B	Spectral Power P/B	
0,1 kHz	100 Ω	-70 dBm	100 Hz	-90 dBm/Hz	A
1 kHz	100 Ω	-70 dBm	100 Hz	-90 dBm/Hz	
1 kHz	100 Ω	-60 dBm	1 kHz	-90 dBm/Hz	
4 kHz	100 Ω	-60 dBm	1 kHz	-90 dBm/Hz	
4 kHz	100 Ω	-50 dBm	10 kHz	-90 dBm/Hz	
50 kHz	100 Ω	-50 dBm	10 kHz	-90 dBm/Hz	
80 kHz	100 Ω	-41,8 dBm	10 kHz	-81,8 dBm/Hz	
120 kHz	100 Ω	+3,5 dBm	10 kHz	-36,5 dBm/Hz	
1 104 kHz	100 Ω	+3,5 dBm	10 kHz	-36,5 dBm/Hz	
3 093 kHz	100 Ω	-50 dBm	10 kHz	-90 dBm/Hz	
11 040 kHz	100 Ω	-50 dBm	10 kHz	-90 dBm/Hz	
30 000 kHz	100 Ω	-50 dBm	10 kHz	-90 dBm/Hz	
100 kHz	100 Ω	$P_{BO} + 50$ dBm	100 kHz	P_{BO} dBm/Hz	B
1 104 kHz	100 Ω	$P_{BO} + 50$ dBm	100 kHz	P_{BO} dBm/Hz	
3 093 kHz	100 Ω	-40 dBm	100 kHz	-90 dBm/Hz	
3 093 kHz	100 Ω	-30 dBm	1 MHz	-90 dBm/Hz	
4 545 kHz	100 Ω	-50 dBm	1 MHz	-110 dBm/Hz	
30 000 kHz	100 Ω	-50 dBm	1 MHz	-110 dBm/Hz	

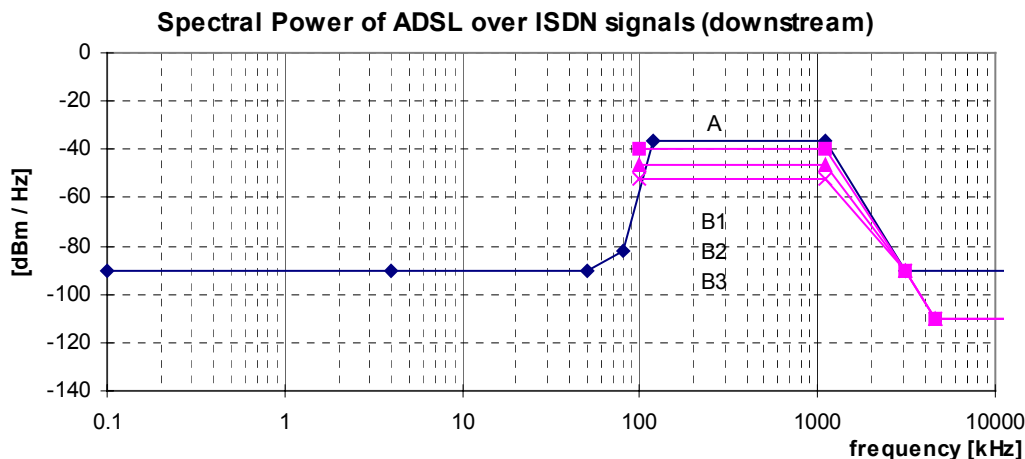

Figure 42: Spectral Power, for ADSL over ISDN signals, as specified in table 78. The maximum spectral power varies with the value of parameter P_{BO} , as defined in table 79. Only the curves for the values $P_{BO} = -40$ dBm/Hz, $P_{BO} = -46$ dBm/Hz, and $P_{BO} = -52$ dBm/Hz are shown here

Power back-off. To be compliant with this signal category, the maximum downstream signal power shall be reduced when the received upstream power is above specified levels. If the total received upstream power from 170,34 kHz to 222,09 kHz (ADSL sub-carriers 40-51) is greater than 0 dBm into 100 ohm then parameter P_{BO} shall not exceed the values shown in table 79. The received upstream power measurement shall be performed with an accuracy of ± 1 dB or better.

Reference: TS 101 388 [18], subclause 7.17, (Uses subcarrier 40-51, values that have been adopted here).

Reference: ITU-T Recommendation G.992.1 [21], subclause B.3.3 (Uses subcarrier 36-51, values that have been ignored here).

Table 79: Definition of parameter P_{BO} , as used in table 78 (Power Back-off, or Power Cut-Back)

Upstream received power (dBm)	< 0	< 1,5	< 3	< 4,5	< 6	< 7,5	< 9
Parameter P_{BO}	-40	-42	-44	-46	-48	-50	-52

11.2.5 Narrow-band signal power (upstream only)

To be compliant with this signal category, the narrow-band signal power (NBSP) into a resistive load impedance R , shall not exceed the limits given in table 80, at any point in the frequency range 100 Hz to 30 MHz. This table specifies the break points of these limits. Limits for intermediate frequencies can be found by drawing a straight line between the break points on a logarithmic (Hz) - linear (dB) scale. Figure 43 illustrates the NBSP in a bandwidth-normalized way.

The NBSP is the average power P of a sending signal into a load resistance R , within a **power** bandwidth B . The measurement method of the NBSP is described in subclause 13.2.

NOTE: The NBSP specification in table 80 is reconstructed from the commonly used PSD specifications in [18] and [21] (similar to figure 43), and used here since it is much wider applicable. This enables a unified specification method. PSD specifications are adequate when signals are purely random in nature, but cannot cover harmonic components in a signal (would cause infinite high "PSD" levels at these harmonic frequencies). NBSP specifications cover both signal types.

The NBSP specification of this signal category has been split into two overlapping limits. Both upper limits shall hold simultaneously. The 10 kHz bandwidth values represent the "maximum PSD values" from [18] and [21], and includes the pass band ripple. The 100 kHz bandwidth values represent the "average PSD values" in the passband to smooth out the spectral ripple of 3,5 dB. The 1 MHz bandwidth specification is equivalent to the "sliding window" specification in [18] and [21].

Reference: TS 101 388 [18], subclause 6.10, reconstructed from PSD requirements.

Reference: ITU-G992.1 [21], subclause B.2.2 reconstructed from PSD requirements.

Table 80: Break points of the narrow-band power limits

Centre frequency f	Impedance R	Signal Level P	Power bandwidth B	Spectral Power P/B	
0,1 kHz	100 Ω	-70 dBm	100 Hz	-90 dBm/Hz	A
1 kHz	100 Ω	-70 dBm	100 Hz	-90 dBm/Hz	
1 kHz	100 Ω	-60 dBm	1 kHz	-90 dBm/Hz	
4 kHz	100 Ω	-60 dBm	1 kHz	-90 dBm/Hz	
4 kHz	100 Ω	-50 dBm	10 kHz	-90 dBm/Hz	
50 kHz	100 Ω	-50 dBm	10 kHz	-90 dBm/Hz	
80 kHz	100 Ω	-41,8 dBm	10 kHz	-81,8 dBm/Hz	
120 kHz	100 Ω	+5,5 dBm	10 kHz	-34,5 dBm/Hz	
276 kHz	100 Ω	+5,5 dBm	10 kHz	-34,5 dBm/Hz	
614 kHz	100 Ω	-50 dBm	10 kHz	-90 dBm/Hz	
11 040 kHz	100 Ω	-50 dBm	10 kHz	-90 dBm/Hz	
30 000 kHz	100 Ω	-50 dBm	10 kHz	-90 dBm/Hz	
120 kHz	100 Ω	+12 dBm	100 kHz	-38 dBm/Hz	B
276 kHz	100 Ω	+12 dBm	100 kHz	-38 dBm/Hz	
614 kHz	100 Ω	-40 dBm	100 kHz	-90 dBm/Hz	
1 221 kHz	100 Ω	-40 dBm	100 kHz	-90 dBm/Hz	
1 221 kHz	100 Ω	-30 dBm	1 MHz	-90 dBm/Hz	
1 630 kHz	100 Ω	-50 dBm	1 MHz	-110 dBm/Hz	
11 040 kHz	100 Ω	-50 dBm	1 MHz	-110 dBm/Hz	
30 000 kHz	100 Ω	-50 dBm	1 MHz	-110 dBm/Hz	

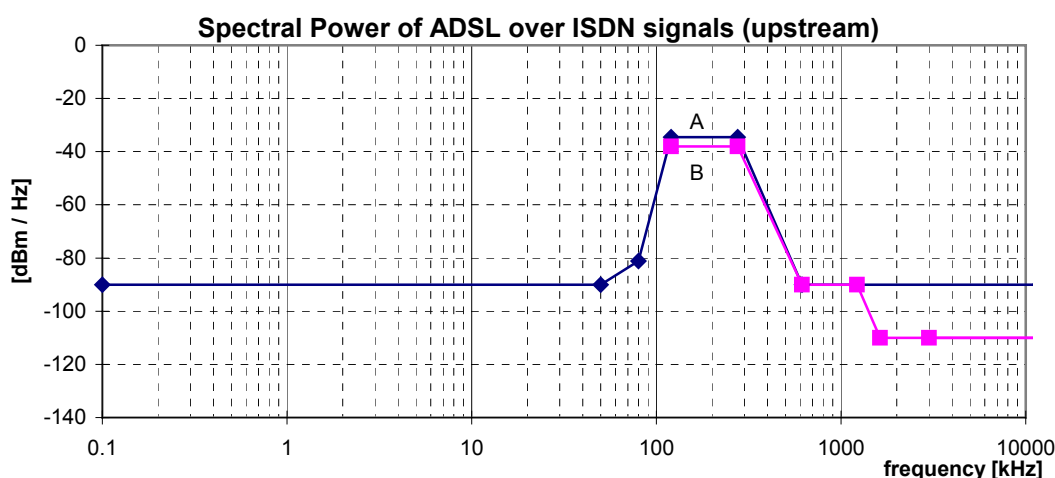

Figure 43: Spectral Power, for ADSL over ISDN signals, as specified in table 80

11.2.6 Unbalance about earth (upstream and downstream)

To be compliant with this signal category, the balance of the signal that may flow through the LT-port or NT-port shall exceed minimum requirements, under the condition that the local loop wiring and its termination is well balanced. This can be verified by a longitudinal output voltage (LOV) and a longitudinal conversion loss (LCL) measurement at the source of that signal, as specified in subclause 13.3.2 and 13.3.3. The minimum LOV and LCL requirements hold for what can be observed at the ports of the Local Loop Wiring, when the Local Loop Wiring is replaced by an artificial impedance network described in subclause 13.3.2 and 13.3.3.

The differential termination impedance for LOV and LCL measurements shall be chosen equally to the design impedance $R_T = 100 \Omega$ of the Signal Source under test.

The observed LOV shall have an rms voltage of below the value specified in table 81, measured in a power bandwidth **B**, centred over any frequency in the range from f_{\min} to f_{\max} , and averaged in any one second period. Compliance with this limitation is required with a longitudinal terminating impedance having value $Z_L(\omega)=R_L+1/(j\omega C_L)$ for all frequencies between f_{\min} to f_{\max} . Subclause 13.3.2 defines an example measurement method for longitudinal output voltage.

The observed LCL shall be higher than the lower limits given in figure 44. The LCL values of the associated break frequencies of this figure are given in table 82. Subclause 13.3.3 defines an example measurement method for longitudinal conversion loss. To be compliant with this signal category, this requirement shall be met for both the switched-on and switched-off mode of the signal source.

Reference: ANSI-T1.413, issue 2 [20], subclause 12.3.1 extended to 30 MHz according to [23].

Reference: TS 101 270-1 [23], subclause 8.3.3 and E.3.2.

Table 81: Values for the LOV limits

	LOV	B	f_{\min}	f_{\max}	R_L	C_L
downstream	-46 dBV	10 kHz	5,1 kHz	1 825 kHz	100 Ω	150 nF
upstream	-46 dBV	10 kHz	5,1 kHz	415 kHz	100 Ω	150 nF

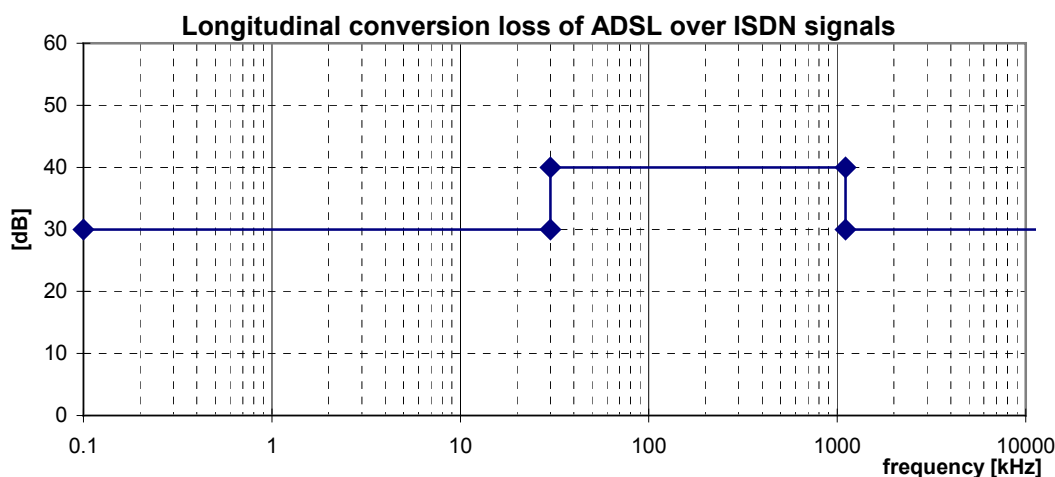

Figure 44: Minimum longitudinal conversion loss

Table 82: Frequencies and LCL values of the breakpoints of the LCL-mask in figure 44

Frequency	LCL
< 30 kHz	30 dB
30 kHz	40 dB
1 104 kHz	40 dB
> 1104 kHz	30 dB

11.3 "ADSL.FDD over POTS" Signals

This category covers signals, generated by ADSL transmission equipment, that work in a Frequency Division Duplexing mode to minimize crosstalk between upstream and downstream signals. This category is a subset of the (full) "ADSL over POTS" signal category.

NOTE: This FDD mode for ADSL is currently under study, within the ETSI-TM6 ADSL project. When that study has been completed, the description of the agreed signal will be included here.

11.4 "ADSL.FDD over ISDN" Signals

This category covers signals, generated by ADSL transmission equipment, that work in a Frequency Division Duplexing mode to minimize crosstalk between upstream and downstream signals. This category is a subset of the (full) "ADSL over ISDN" signal category.

NOTE: This FDD mode for ADSL is currently under study, within the ETSI-TM6 ADSL project. When that study has been completed, the description of the agreed signal will be included here.

12 Cluster 5 Signals (broad band up to 30 MHz)

12.1 "VDSL" Signals

NOTE: The signals that will be generated by VDSL equipment are currently under study, within the ETSI-TM6 [23] and ANSI-T1E1.4 [24] VDSL projects. When that study has been completed, the description of the agreed signal will be included here.

13 Measurement methods of signal parameters

13.1 Peak Amplitude

The peak amplitude is defined as the peak voltage amplitude measured in a continuous sending signal such that the probability of exceeding that amplitude is less than 10^{-7} . It shall be measured into a resistive load **R**, and over a period of not less than 120 seconds. The bandwidth **B** of the measuring instrument shall be as defined in the specification for peak amplitude for the signal under test.

The measurement period of at least 120 seconds is required to generate a peak amplitude to better than $1e-7$ probability for all known DSL types except DMT ADSL. DMT's combination of near-Gaussian distribution and low symbol rate would force a measurement period on the order of 42 minutes to generate $1e7$ symbols – however, 120 seconds will generate a peak measurement on the order of 90% of the $1e-7$ peak.

13.2 Narrow-band signal power (voltage)

The narrow band signal power is defined as the average power **P** of a sending signal into a resistive load **R**, within a *power* bandwidth **B** centred at a specified frequency. The power bandwidth is different from the commonly used -3dB bandwidth, since it fully accounts for the shape of the transfer function $H(f)$ of frequency selective filters while measuring narrow band power (or rms-voltage). The power bandwidth of a frequency selective filter is defined as shown below.

$$B_{power} = \frac{1}{|H_{max}|^2} \int |H(f)|^2 \cdot df$$

13.3 Unbalance about earth

Poor balance of a signal source, connected to a local loop wiring, leads to conditions in the network where systems using the same cable could be harmed. If the combination of system and wire pair shows a poor balance about earth, this will result in unwanted radiated emissions (egress) which will be visible in the environment of the wire pair and which also will be received by adjacent wire pairs (crosstalk).

13.3.1 Definition of earth

Measurements of both LOV and LCL must be considered as 3 terminal measurements. These terminals are the conductors of a port to the Local Loop Wiring or to a signal source (ESS, CSS or RSS). Two terminals are those of the differential mode and the third terminal is that of the earth used of the common mode.

- In the case of a signal source that is connected to a local earth point, then the measurement equipment should be connected to the same earth point. The earth point of the measurement equipment should be taken from a point close to the measurement port of the equipment. The connection to the earth point of the signal source should be of low impedance.
- In the case of a signal source that has no reference to earth, then that source must be placed centrally on an earthed copper or similar high conductivity metal plate of dimension greater than twice the area of the minimum rectangle bounding the perimeter of the signal source. The earth point of the measurement equipment should be taken from a point close to the measurement port of the equipment. The connection to the metal plane should be of low impedance.

13.3.2 Transmitter Balance - LOV

The balance of transmitters is normally expressed in the "Longitudinal Output Voltage" (LOV). This is the common mode portion of the generated signal, and specified for many transmission systems defined by ETSI TM6 (e.g. [12] and [13]).

The longitudinal output voltage is the longitudinal component of the output signal which occurs on the line interface (ports of the local loop wiring). The definition of the LOV can be found in the ITU-T Recommendation [26].

Figure 45 gives an example measurement method for longitudinal output voltage. Further examples can be derived from [25] and [26]. For direct use of this test configurations, the IUT should be able to generate a signal in the absence of a signal from the far end. The ground reference for these measurements shall be the building ground.

NOTE: During regenerator test (where required) each wire on the side which is not under test has to be connected to ground by a terminating impedance having the value of $R_T/2 \ \Omega$ in series with a capacitance of at least 330 nF.

References: ITU-T Recommendation O.9 [25].

References: ITU-T Recommendation G.117 [26].

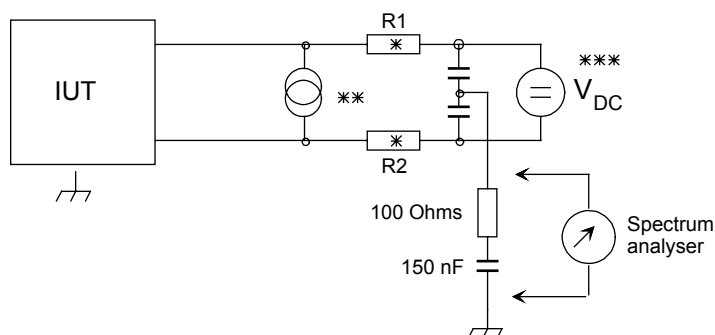

- NOTE: * These resistors have to be matched: $R1 = R2 = R_T/2$ and $R1/R2 = 1 \pm 0,1 \%$
 ** For LTU test only if remote power feeding is supplied
 *** For NTU test only if remote power feeding is required DC blocking capacitors = C_B

Figure 45: Measurement method for longitudinal output voltage (LOV)

- NOTE: The value of the components C_B is to be considered carefully for the frequency range and design impedance the measuring adapter is used for. At low frequencies other measurement methods could be more appropriate.

13.3.3 Receiver Balance - LCL

The balance of receivers is normally expressed in the "Longitudinal Conversion Loss" (LCL). The definition of the LCL can be found in [25]. Additionally, LCL is specified for all transmission systems defined by ETSI TM6 (e.g. [12] and [13])

The (LCL) longitudinal conversion loss is given by: $LCL = 20 \log(e_l/e_m)$ [dB] where e_l is the applied longitudinal voltage referenced to the building ground and e_m is the resultant metallic voltage appearing across a termination with the impedance as given in the relevant section (see figure 46).

Figure 46 defines an example of the measurement method for the longitudinal conversion loss (LCL). The LCL is given by: $LCL = 20 \log(e_l/e_m)$ [dB] where e_l is the applied longitudinal voltage referenced to the building ground and e_m is the resultant metallic voltage appearing across a defined termination. Measurement should be performed with the IUT powered up but inactive (no transmit signal).

References: ITU-T Recommendation O.9 [25].

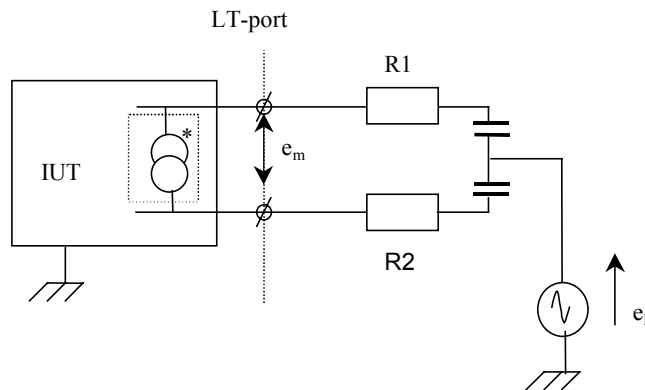

* For LT test only if remote powering is supplied.

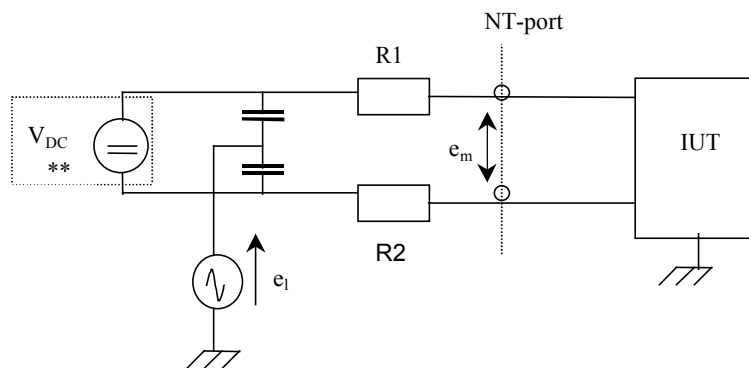

** For NT test only if remote powering is required. The power supply shall have at least an impedance of $10 * (R1+R2)$ for the test frequencies of the LCL.

NOTE: *** DC blocking capacitors = C_B .

Figure 46: Measurement method for longitudinal conversion loss

NOTE: The value of the components C_B is to be considered carefully for the frequency range and design impedance the measuring adapter is used for. At low frequencies other measurement methods could be more appropriate.

Bibliography

The following material, though not specifically referenced in the body of the present document (or not publicly available), gives supporting information.

- ETSI WG TM6, 980p09a0, Permanent Document TM6(98)9, Rev. 1, Living List for TS 101 524-1 [14].
- ETSI-TM6(97)02: "Cable reference models for simulating metallic access networks", R.F.M. van den Brink, ETSI-TM6, Permanent document TM6(97)02, revision 3, Luleå, Sweden, June 1998.
- ETSI STC TM6, TD 16 meeting, 22-26 June 1998, Luleå, Sweden, 983t16a0, PSD + Crest factor is not sufficient to specify noise in performance tests.
- ETSI STC TM6, TD 42 meeting, 21-25 September 1998, Vienna, Austria, 984t42a0, Specification of crest distribution mask for noise in performance tests.

History

Document history		
V1.1.1	August 2000	Publication of first version
	6 nov 2000	Definition of Peak amplitude added, plus a ref to 13.1 from all specifications; Inclusion of (draft) "SDSL" signal description, as well as "Proprietary.SymDSL.CAP.QAM" and "Proprietary.PCM.HDB3.SQ" signals. Remark added to the scope on the tolerance of values that are specified in the library.
	2 feb 2001	Refinement of "SDSL" description and "Proprietary.SymDSL.CAP/QAM" (TD7, WD5 Monterey). Addition of "Proprietary.SymDSL.CAP.C (WD6 Monterey) Isolation of DC-power feeding from AC-signal description by creating a Cluster "0" dedicated to power feeding issues.
	2 may 2001	Changes of "Proprietary.SymDSL.2B1Q" according to WD08 (sophia Antipolis) Changes of "Proprietary.SymDSL.CAP.A" + "..CAP.B" (TD22 Sophia Antipolis) Extention of powerfeeding (cluster 0 Signals) according to TD11 (Sophia Antip.)