

**Transmission and Multiplexing (TM);
Access networks;
Spectral management on metallic access networks;
Part 2: Technical methods for performance evaluations**



Reference

RTR/ATTM-06004-2

Keywords

access, ADSL, HDSL, ISDN, VDSL, xDSL, local loop, modem, network, POTS, SDSL, spectral management, transmission, unbundling

ETSI

650 Route des Lucioles
F-06921 Sophia Antipolis Cedex - FRANCE

Tel.: +33 4 92 94 42 00 Fax: +33 4 93 65 47 16

Siret N° 348 623 562 00017 - NAF 742 C
Association à but non lucratif enregistrée à la
Sous-Préfecture de Grasse (06) N° 7803/88

Important notice

Individual copies of the present document can be downloaded from:

<http://www.etsi.org>

The present document may be made available in more than one electronic version or in print. In any case of existing or perceived difference in contents between such versions, the reference version is the Portable Document Format (PDF). In case of dispute, the reference shall be the printing on ETSI printers of the PDF version kept on a specific network drive within ETSI Secretariat.

Users of the present document should be aware that the document may be subject to revision or change of status. Information on the current status of this and other ETSI documents is available at

<http://portal.etsi.org/tb/status/status.asp>

If you find errors in the present document, please send your comment to one of the following services:

http://portal.etsi.org/chaicor/ETSI_support.asp

Copyright Notification

No part may be reproduced except as authorized by written permission.
The copyright and the foregoing restriction extend to reproduction in all media.

© European Telecommunications Standards Institute 2008.
All rights reserved.

DECT™, PLUGTESTS™, UMTS™, TIPHON™, the TIPHON logo and the ETSI logo are Trade Marks of ETSI registered for the benefit of its Members.

3GPP™ is a Trade Mark of ETSI registered for the benefit of its Members and of the 3GPP Organizational Partners.

Contents

Intellectual Property Rights	5
Foreword.....	5
1 Scope	6
2 References	6
2.1 Normative references	7
2.2 Informative references.....	7
3 Definitions and abbreviations.....	8
3.1 Definitions.....	8
3.2 Abbreviations	10
4 Transmitter signal models for xDSL	11
4.1 Generic transmitter signal model.....	11
4.2 Transmitter signal model for "ISDN.2B1Q"	12
4.3 Transmitter signal model for "ISDN.2B1Q/filtered".....	13
4.4 Line-shared signal model for "ISDN.2B1Q"	14
4.5 Transmitter signal model for "ISDN.MMS43"	15
4.6 Transmitter signal model for "ISDN.MMS43/filtered"	15
4.7 Line-shared signal model for "ISDN.MMS43"	16
4.8 Transmitter signal model for "HDSL.2B1Q"	17
4.9 Transmitter signal model for "HDSL.CAP"	18
4.10 Transmitter signal model for "SDSL"	19
4.11 Transmitter signal model for "ADSL/POTS (FO)"	20
4.12 Transmitter signal model for "ADSL/POTS (FDD)"	20
4.13 Transmitter signal model for "ADSL/ISDN (FO)"	22
4.14 Transmitter signal model for "ADSL/ISDN (FDD)".....	23
4.15 Transmitter signal model for "ADSL2/J (FDD)"	24
4.16 Transmitter signal model for "ADSL2/M (FDD)"	25
4.17 Transmitter signal model for "VDSL1"	26
4.17.1 Templates compliant with the ETSI main band plan	28
4.17.2 Templates compliant with the ETSI optional band plan.....	31
4.18 Transmitter signal models for "VDSL2"	34
4.18.1 Noise floor	35
4.18.2 Building block #1 for "PSD Band Constructor"	35
4.18.3 Building block #2 for "PSD Shaper"	37
4.18.4 Building block #3 for "PSD notcher"	37
4.18.5 Building block #4 for "PSD Power Restrictor".....	38
4.18.6 Pre-defined downstream tables for "PSD Band Constructor".....	39
4.18.7 Pre-defined upstream tables for "PSD Band Constructor".....	43
4.18.8 Example definitions of VDSL2 transmitters.....	46
5 Generic receiver performance models for xDSL.....	47
5.1 Generic input models for effective SNR	49
5.1.1 First order input model	49
5.2 Generic detection models	51
5.2.1 Generic Shifted Shannon detection model.....	51
5.2.2 Generic PAM detection model.....	52
5.2.3 Generic CAP/QAM detection model	53
5.2.4 Generic DMT detection model	54
5.3 Generic models for echo coupling.....	57
5.3.1 Linear echo coupling model.....	57
6 Specific receiver performance models for xDSL	58
6.1 Receiver performance model for "HDSL.2B1Q"	58
6.2 Receiver performance model for "HDSL.CAP".....	59
6.3 Receiver performance model for "SDSL"	59
6.4 Receiver performance model for "ADSL/POTS (FO)"	60

6.5	Receiver performance model for "ADSL/POTS (FDD)"	61
6.6	Receiver performance model for "ADSL/ISDN (FO)"	63
6.7	Receiver performance model for "ADSL/ISDN (FDD)"	64
6.8	Receiver performance model for "VDSL"	65
7	Transmission and reflection models	66
7.1	Summary of test loop models	66
8	Crosstalk models	66
8.1	Basic models for crosstalk cumulation	66
8.1.1	Uniform cumulation model	67
8.1.2	FSAN sum for crosstalk cumulation	68
8.2	Basic models for NEXT and FEXT coupling	68
8.2.1	Normalized NEXT and FEXT coupling at an elementary cable section	69
8.2.2	Normalized NEXT and FEXT coupling at distributed or branched cables	69
8.3	Basic models for crosstalk injection	71
8.3.1	Forced noise injection	71
8.3.2	Current noise injection	72
8.4	Overview of different network topologies	72
8.5	Crosstalk evaluation for multi-node topologies	73
8.6	Crosstalk evaluation for two-node topologies	74
9	Examples of evaluating various scenarios	77
9.1	European Spectral Platform 2004 (ESP/2004)	77
9.1.1	Technology mixtures within ESP/2004	77
9.1.2	System models within ESP/2004	78
9.1.3	Topology models within ESP/2004	79
9.1.4	Loop models within ESP/2004	82
9.1.5	Scenarios within ESP/2004	83
Annex A:	Bibliography	84
History		85

Intellectual Property Rights

IPRs essential or potentially essential to the present document may have been declared to ETSI. The information pertaining to these essential IPRs, if any, is publicly available for **ETSI members and non-members**, and can be found in ETSI SR 000 314: "*Intellectual Property Rights (IPRs); Essential, or potentially Essential, IPRs notified to ETSI in respect of ETSI standards*", which is available from the ETSI Secretariat. Latest updates are available on the ETSI Web server (<http://webapp.etsi.org/IPR/home.asp>).

Pursuant to the ETSI IPR Policy, no investigation, including IPR searches, has been carried out by ETSI. No guarantee can be given as to the existence of other IPRs not referenced in ETSI SR 000 314 (or the updates on the ETSI Web server) which are, or may be, or may become, essential to the present document.

Foreword

This Technical Report (TR) has been produced by ETSI Technical Committee Access, Terminals, Transmission and Multiplexing (ATTM).

The present document is part 2 of a multi-part deliverable covering Transmission and Multiplexing (TM); Access networks; Spectral management on metallic access networks, as identified below:

Part 1: "Definitions and signal library";

Part 2: "Technical methods for performance evaluations";

1 Scope

The present document gives guidance on a common methodology for studying the impact of noise on xDSL performance (maximum reach, noise margin, maximum bitrate) when changing parameters within various Spectral Management scenarios. These methods enable reproducible results and a consistent presentation of the assumed conditions (characteristics of cables and xDSL equipment) and configuration (chosen technology mixture and cable fill) of each scenario.

The technical methods include computer models for estimating:

- xDSL receiver capability of detecting signals under noisy conditions;
- xDSL transmitter characteristics;
- cable characteristics;
- crosstalk cumulation in cables, originating from a mix of xDSL disturbers.

The objective is to provide the technical means for evaluating the performance of xDSL equipment within a chosen scenario. This includes the description of performance properties of equipment.

Another objective is to assist the reader with applying this methodology by providing examples on how to specify the configuration and the conditions of a scenario in an unambiguous way. The distinction is that a configuration of a scenario can be controlled by access rules while the conditions of a scenario cannot.

Possible applications of the present document include:

- Studying access rules, for the purpose of bounding the crosstalk in unbundled networks.
- Studying deployment rules, for the various systems present in the access network.
- Studying the impact of crosstalk on various technologies within different scenarios.

The scope of the present document is explicitly restricted to the methodology for defining scenarios and quantifying the performance of equipment within such a scenario. All judgement on what access rules are required, what performance is acceptable, or what combinations are spectral compatible, is explicitly beyond the scope of the present document. The same applies for how realistic the example scenarios are.

The models in the present document are not intended to set requirements for DSL equipment. These requirements are contained in the relevant transceiver specifications. The models in the present document are intended to provide a reasonable estimate of real-world performance but may not include every aspect of modem behaviour in real networks. Therefore real-world performance may not accurately match performance numbers calculated with these models.

2 References

References are either specific (identified by date of publication and/or edition number or version number) or non-specific.

- For a specific reference, subsequent revisions do not apply.
- Non-specific reference may be made only to a complete document or a part thereof and only in the following cases:
 - if it is accepted that it will be possible to use all future changes of the referenced document for the purposes of the referring document;
 - for informative references.

Referenced documents which are not found to be publicly available in the expected location might be found at <http://docbox.etsi.org/Reference>.

For online referenced documents, information sufficient to identify and locate the source shall be provided. Preferably, the primary source of the referenced document should be cited, in order to ensure traceability. Furthermore, the reference should, as far as possible, remain valid for the expected life of the document. The reference shall include the method of access to the referenced document and the full network address, with the same punctuation and use of upper case and lower case letters.

NOTE: While any hyperlinks included in this clause were valid at the time of publication ETSI cannot guarantee their long term validity.

2.1 Normative references

The following referenced documents are indispensable for the application of the present document. For dated references, only the edition cited applies. For non-specific references, the latest edition of the referenced document (including any amendments) applies.

Not applicable.

2.2 Informative references

The following referenced documents are not essential to the use of the present document but they assist the user with regard to a particular subject area. For non-specific references, the latest version of the referenced document (including any amendments) applies.

SpM

- [i.1] ETSI TR 101 830-1: "Transmission and Multiplexing (TM); Access networks; Spectral management on metallic access networks; Part 1: Definitions and signal library".
- [i.2] ANSI T1E1.4, T1.417-2003: "Spectrum Management for loop transmission systems".

ISDN

- [i.3] ETSI TS 102 080: "Transmission and Multiplexing (TM); Integrated Services Digital Network (ISDN) basic rate access; Digital transmission system on metallic local lines".

HDSL

- [i.4] ETSI TS 101 135: "Transmission and Multiplexing (TM); High bit-rate Digital Subscriber Line (HDSL) transmission systems on metallic local lines; HDSL core specification and applications for combined ISDN-BA and 2 048 kbit/s transmission".

SDSL

- [i.5] ETSI TS 101 524: "Transmission and Multiplexing (TM); Access transmission system on metallic access cables; Symmetric single pair high bitrate Digital Subscriber Line (SDSL)".
- [i.6] ITU-T Recommendation G.991.2: "Single-Pair High-Speed Digital Subscriber Line (SHDSL) transceivers".

ADSL

- [i.7] ETSI TS 101 388: "Transmission and Multiplexing (TM); Access transmission systems on metallic access cables; Asymmetric Digital Subscriber Line (ADSL) - European specific requirements [ITU-T Recommendation G.992.1 modified]".
- [i.8] ITU-T Recommendation G.992.1: "Asymmetric digital subscriber line (ADSL) transceivers".
- [i.9] ITU-T Recommendation G.992.3: "Asymmetric digital subscriber line (ADSL) transceivers - 2 (ADSL2)".

- [i.10] ITU-T Recommendation G.992.5: "Asymmetric digital subscriber line (ADSL) transceivers - extended bandwidth ADSL2 (ADSL2plus)".

VDSL

- [i.11] ETSI TS 101 270-1: "Transmission and Multiplexing (TM); Access transmission systems on metallic access cables; Very high speed Digital Subscriber Line (VDSL); Part 1: Functional requirements".
- [i.12] ETSI TS 101 271: "Access Terminals Transmission and Multiplexing (ATTM); Access transmission systems on metallic pairs; Very high speed Digital Subscriber Line system (VDSL2)". [ITU-T Recommendation G993.2, modified].
- [i.13] ITU-T Recommendation G993.2: "Very High Speed Digital Subscriber Line 2 (VDSL2)".

SPLITTERS

- [i.14] ETSI TS 101 952-1-3: "Access network xDSL transmission filters; Part 1: ADSL splitters for European deployment; Sub-part 3: Specification of ADSL/ISDN splitters".
- [i.15] ETSI TS 101 952-1-4: "Access network xDSL transmission filters; Part 1: ADSL splitters for European deployment; Sub-part 4: Specification of ADSL over "ISDN or POTS" universal splitters".

OTHER

- [i.16] ITU-T Recommendation G997.1: "Physical layer management for digital subscriber line (DSL) receivers".

3 Definitions and abbreviations

3.1 Definitions

For the purposes of the present document, the following terms and definitions apply:

access port: physical location, appointed by the loop provider, where signals (for transmission purposes) are injected into the local loop wiring

access rule: mandatory rule for achieving access to the local loop wiring, equal for all network operators who are making use of the same network cable that bounds the crosstalk in that network cable

cable fill (or degree of penetration): number and mixture of transmission techniques connected to the ports of a binder or cable bundle that are injecting signals into the access ports

Cable Management Plan (CMP): list of selected access rules dedicated to a specific network

NOTE: This list may include associated descriptions and explanations.

deployment rule: voluntary rule, irrelevant for achieving access to the local loop wiring and proprietary to each individual network operator

NOTE: A deployment rule reflects a network operator's own view about what the maximum length or maximum bitrate may be for offering a specific transmission service to ensure a chosen minimum quality of service.

disturber: source of interference in spectral management studies coupled to the wire pair connecting victim modems

NOTE: This term is intended solely as a technical term, defined within the context of these studies, and is not intended to imply any negative judgement.

downstream transmission: transmission direction from port, labelled as LT-port, to a port, labelled as NT-port

NOTE: This direction is usually from the central office side via the local loop wiring, to the customer premises.

Echo Cancelled (EC): term used within the context of ADSL to designate ADSL (FO) systems with frequency overlap of downstream and upstream signals

NOTE: In this context, the usage of the abbreviation "EC" was only kept for historical reasons. The usage of the echo cancelling technology is not only limited to FO systems (frequency overlapped), but can also be used by FDD systems (frequency division duplexing).

local loop wiring: part of a metallic access network, terminated by well-defined ports, for transporting signals over a distance of interest

NOTE: This part includes mainly cables, but may also include a Main Distribution Frame (MDF), street cabinets, and other distribution elements. The local loop wiring is usually passive only, but may include active splitter-filters as well.

loop provider: organization facilitating access to the local loop wiring

NOTE: In several cases the loop provider is historically connected to the incumbent network operator, but other companies may serve as loop provider as well.

LT-access port (or LT-port for short): access port for injecting signals, designated as "LT-port"

NOTE: Such a port is commonly located at the central office side, and intended for injecting "downstream" signals.

max data rate: maximum data rate that can be recovered according to predefined quality criteria, when the received noise is increased with a chosen noise margin (or the received signal is decreased with a chosen signal margin)

network operator: organization that makes use of a local loop wiring for transporting telecommunication services

NOTE: This definition covers incumbent as well as competitive network operators.

noise margin: ratio (P_{n2}/P_{n1}) by which the received noise power P_{n1} may increase to power P_{n2} until the recovered signal no longer meets the predefined quality criteria

NOTE: This ratio is commonly expressed in dB.

NT-access port (or NT-port for short): is an access port for injecting signals, designated as "NT-port"

NOTE: Such a port is commonly located at the customer premises, and intended for injecting "upstream" signals.

performance: is a measure of how well a transmission system fulfils defined criteria under specified conditions

NOTE: Such criteria include reach, bitrate and noise margin.

power back-off: is a generic mechanism to reduce the transmitter's output power

NOTE: It has many purposes, including the reduction of power consumption, receiver dynamic range, crosstalk, etc.

power cut-back: specific variant of power back-off, used to reduce the dynamic range of the receiver, that is characterized by a frequency independent reduction of the in-band PSD

NOTE: It is used, for instance, in ADSL and SDSL.

PSD mask: absolute upper bound of a PSD, measured within a specified resolution band

NOTE: The purpose of PSD masks is usually to specify maximum PSD levels for stationary signals.

PSD template: expected average PSD of a stationary signal

NOTE: The purpose of PSD templates is usually to perform simulations. The levels are usually below or equal to the associated PSD masks.

signal category: is a class of signals meeting the minimum set of specifications identified in TR 101 830-1 [i.1]

NOTE: Some signal categories may be distinct between different sub-classes, and may label them for instance as signals for "downstream" or for "upstream" purposes.

signal margin: ratio (P_{s1}/P_{s2}) by which the received signal power P_{s1} may decrease to power P_{s2} until the recovered signal no longer meets the predefined quality criteria

NOTE: This ratio is commonly expressed in dB.

spectral compatibility: generic term for the capability of transmission systems to operate in the same cable

NOTE: The precise definition is application dependent and has to be defined for each group of applications.

spectral management: art of making optimal use of limited capacity in (metallic) access networks

NOTE: This is for the purpose of achieving the highest reliable transmission performance and includes:

- Designing of deployment rules and their application.
- Designing of effective access rules.
- Optimized allocation of resources in the access network, e.g. access ports, diversity of systems between cable bundles, etc.
- Forecasting of noise levels for fine-tuning the deployment.
- Spectral policing to enforce compliance with access rules.
- Making a balance between conservative and aggressive deployment (low or high failure risk).

spectral management rule: generic term, incorporating (voluntary) deployment rules, (mandatory) access rules and all other (voluntary) measures to maximize the use of local loop wiring for transmission purposes

transmission equipment: equipment connected to the local loop wiring that uses a transmission technique to transport information

transmission system: set of transmission equipment that enables information to be transmitted over some distance between two or more points

transmission technique: electrical technique used for the transportation of information over electrical wiring

upstream transmission: transmission direction from a port, labelled as NT-port, to a port, labelled as LT-port

NOTE: This direction is usually from the customer premises, via the local loop wiring, to the central office side.

victim modem: modem, subjected to interference (such as crosstalk from all other modems connected to other wire pairs in the same cable) that is being studied in a spectral management analysis

NOTE: This term is intended solely as a technical term, defined within the context of these studies, and is not intended to imply any negative judgement.

3.2 Abbreviations

For the purposes of the present document, the following abbreviations apply:

2B1Q	2-Binary, 1-Quaternary (Use of 4-level PAM to carry two bits per pulse)
ADSL	Asymmetric Digital Subscriber Line
BER	Bit Error Ratio
CAP	Carrier less Amplitude/Phase modulation
CMP	Cable Management Plan
DFE	Decision Feedback Equalizer
DMT	Discrete MultiTone modulation
EC	Echo Cancelled
EPL	Estimated Power Loss

FBL	Fractional Bit Loading
FDD	Frequency Division Duplexing/Duplexed
FO	Frequency Overlap, previously referred to as Echo Cancelled (EC)
FSAN	Full Service Access Network
GABL	Gain Adjusted Bit Loading
HDSL	High bitrate Digital Subscriber Line
ISDN	Integrated Services Digital Network
LT-port	Line Termination - port (<i>commonly at central office side</i>)
LTU	Line Termination Unit
MDF	Main Distribution Frame
NT-port	Network Termination - port (<i>commonly at customer side</i>)
NTU	Network Termination Unit
PAM	Pulse Amplitude Modulation
PBO	Power Back-Off
PSD	Power Spectral Density (single sided)
QAM	Quadrature Amplitude Modulation
RBL	Rounded Bit Loading
SDSL	Symmetrical (single pair high bitrate) Digital Subscriber Line
SNR	Signal to Noise Ratio (<i>ratio of powers</i>)
TBL	Truncated Bit Loading
TRA	TRAnsmitter
UC	Ungerboeck Coded (also known as trellis coded)
VDSL	Very-high-speed Digital Subscriber Line
xDSL	(all systems) Digital Subscriber Line

4 Transmitter signal models for xDSL

A transmitter model in this clause is mainly a PSD description of the transmitted signal under matched conditions, plus an output impedance description to cover mismatched conditions as well.

PSD *masks* of transmitted xDSL signals are specified in several documents for various purposes, for instance in TR 101 830-1 [i.1]. These PSD masks, however, cannot be applied directly to the description of a transmitter model. One reason is that masks are specifying an upper limit, and not the expected (averaged) values. Another reason is that the definition of the true PSD of a time-limited signal requires no resolution bandwidth at all (it is defined by means of an autocorrelation, followed by a Fourier transform) while PSD *masks* do rely on some resolution bandwidth. They describe values that are (slightly) different from the true PSD; especially at steep edges (e.g. guard bands), and for modelling purposes this difference is sometimes very relevant.

To differentiate between several PSD descriptions, *masks* and *templates* of a PSD are given a different meaning. Masks are intended for proving compliance to standard requirements, while templates are intended for modelling purposes. This clause summarizes various xDSL transmitter models, by defining *template* spectra of output signals.

In some cases, models are marked as "default" and/or as "alternative". Both models are applicable, but in case a preference of either of them does not exist, the use of the "default" models is recommended. Other (alternative) models may apply as well, provided that they are specified.

4.1 Generic transmitter signal model

A generic model of an xDSL transmitter is essentially a linear signal source. The Thevenin equivalent of such a source equals an ideal voltage source U_s having a real resistor R_s in series. The output voltage of this source is random in nature (as a function of the time), and occupies a relatively broad spectrum. Correlation between transmitters is taken to be negligible. The autocorrelation properties of a transmitter's signal are taken to be adequately represented by a PSD template.

This generic model can be made specific by defining:

- The output impedance R_s of the transmitter.
- The template of the PSD, measured at the output port, when terminated with an external impedance equal to R_s . This is identified as the "matched condition", and under this condition the output power equals the maximum power that is available from this source. Under all other (mis-matched) termination conditions the output power will be lower.

4.2 Transmitter signal model for "ISDN.2B1Q"

The PSD template for modelling the "ISDN.2B1Q" transmit spectrum is defined by the theoretical sinc-shape of PAM encoded signals, with additional filtering and with a noise floor. The PSD is the maximum of both power density curves, as summarized in expression 1 and the associated table 1. The coefficient q_N scales the total signal power of $P_1(f)$ to a value that equals P_{ISDN} . This value is dedicated to the used filter characteristics, but equals $q_N=1$ when no filtering is applied ($f_L \rightarrow 0, f_H \rightarrow \infty$). The source impedance equals 135 Ω .

$P_1(f) = P_{ISDN} \times \frac{2 \times q_N}{f_X} \times \text{sinc}^2\left(\frac{f}{f_X}\right) \times \frac{1}{1 + \left(\frac{f}{f_H}\right)^{2 \cdot N_H}} \times \frac{1}{1 + \left(\frac{f_L}{f}\right)^2}$	[W / Hz]
$P_2(f) = \frac{10^{(P_{floor_dBm}/10)}}{1000}$	[W / Hz]
$P(f) = \max(P_1(f), P_2(f))$	[W / Hz]
<p>Where:</p> $P_{ISDN} = \left(10^{P_{ISDN_dBm}/10}\right) / 1000 \text{ [W]}$ $R_s = 135 \text{ [\Omega]}$ $\text{sinc}(x) = \sin(\pi \cdot x) / (\pi \cdot x)$ <p><i>Default values for remaining parameters are summarized in table 1.</i></p>	

Expression 1: PSD template for modelling "ISDN.2B1Q" signals

Different ISDN implementations, may use different filter characteristics, and noise floor values. Table 1 specifies *default* values for ISDN implementations, in the case where 2nd order Butterworth filtering has been applied. The default noise floor equals the maximum PSD level that meets the out-of-band specification of the ISDN standard (TS 102 080 [i.3]).

Table 1: Default parameter values for the ISDN.2B1Q templates, as defined in expression 1

Type	f_X [kHz]	f_H [kHz]	f_L [kHz]	NH	q_N	P_{ISDN_dBm} [dBm]	P_{floor_dBm} [dBm/Hz]
ISDN.2B1Q	80	$1 \times f_X$	0	2	1,1257	13,5	-120

NOTE: These default values are based on 2nd order Butterworth filtering.

4.3 Transmitter signal model for "ISDN.2B1Q/filtered"

When ISDN signals have to pass a low-pass filter (such as in an ADSL splitter) before they reach the line, the disturbance caused by these ISDN systems to other wire pairs will change, as well as their performance. SpM studies should therefore make a distinction between crosstalk generated from ISDN systems connected directly to the line and filtered ISDN systems.

The PSD template for modelling a "ISDN.2B1Q/filtered" transmitter signal that has passed a low-pass splitter/filter, is defined in table 2 in terms of break frequencies. It has been constructed from the transmitter PSD template, filtered by the low-pass transfer function representing the splitter/filter.

The values are based on filter assumptions according to splitter specifications in TS 101 952-1-3 [i.14] and TS 101 952-1-4 [i.15]. The associated values are constructed with straight lines between these break frequencies, when plotted against a *logarithmic* frequency scale and a *linear* dBm scale.

Table 2: PSD template for modelling "ISDN.2B1Q/filtered" signals

ISDN.2B1Q/filtered	(135Ω)
f [Hz]	PSD [dBm/Hz]
1 k	-32,1
10 k	-32,3
20 k	-33,1
30 k	-34,5
40 k	-36,6
50 k	-39,8
60 k	-44,5
65 k	-47,8
70 k	-52,2
75 k	-59,3
80 k	-126,5
85 k	-61,9
90 k	-57,4
100 k	-55,2
110 k	-57,9
115 k	-62,9
120 k	-68,2
125 k	-79,3
130 k	-90,8
135 k	-104,1
140 k	-117,9
145 k	-132,8
150 k	-136,9
160 k	-140,0
170 k	-140,0
180 k	-136,2
190 k	-135,2
200 k	-135,8
210 k	-137,8
220 k	-140,0
30 M	-140,0

4.4 Line-shared signal model for "ISDN.2B1Q"

The PSD template for modelling the line-shared signal from an ISDN.2B1Q transmitter that has passed the low-pass and the high-pass part of a splitter/filter for sharing the line with ADSL signals, is defined in table 3 in terms of break frequencies. It has been constructed from the transmitter PSD template, filtered by the low-pass and the high-pass transfer function representing the splitter/filter.

The values are based on filter assumptions according to splitter specifications in TS 101 952-1-3 [i.14] and in TS 101 952-1-4 [i.15]. The associated values are constructed with straight lines between these break frequencies, when plotted against a *logarithmic* frequency scale and a *linear* dBm scale.

Table 3: PSD template for modelling line shared "ISDN.2B1Q" signals

Line-shared ISDN.2B1Q	(135Ω)
f [Hz]	PSD [dBm/Hz]
1 k	-40,1
10 k	-40,3
20 k	-41,0
30 k	-42,2
40 k	-44,1
50 k	-46,8
60 k	-51,1
65 k	-54,2
70 k	-58,3
75 k	-65,1
80 k	-127,0
85 k	-66,9
90 k	-61,9
100 k	-59,0
110 k	-61,2
115 k	-65,9
120 k	-70,9
125 k	-81,7
130 k	-93,0
135 k	-106,1
140 k	-119,4
145 k	-134,1
150 k	-138,0
160 k	-140,0
170 k	-140,0
180 k	-137,2
190 k	-136,2
200 k	-136,8
210 k	-138,8
220 k	-140,0
30 M	-140,0

4.5 Transmitter signal model for "ISDN.MMS43"

The PSD template for modelling the "ISDN.MMS43" transmit spectrum (also known as ISDN.4B3T) is defined by a combination of a theoretical curve and a noise floor. The PSD is the maximum of both power density curves, as summarized in expression 2. The source impedance equals 150 Ω .

$P_1(f) = P_{ISDN} \times \frac{2}{f_0} \times \left[\text{sinc}^2\left(\frac{f}{f_0}\right) + \text{sinc}^2\left(\frac{f - f_{P1}}{f_0}\right) + \text{sinc}^2\left(\frac{f - f_{P2}}{f_0}\right) \right] \times \frac{1}{1 + \left(\frac{f}{f_{L1}}\right)^4} \times \frac{1}{1 + \left(\frac{f}{f_{L2}}\right)^4} \quad [W / Hz]$
$P(f) = P_1(f) + P_{floor} \quad [W / Hz]$
<p>Where:</p> $P_{ISDN} = \left(10^{P_{ISDN_dBm}/10}\right) / 1000 \quad [W], \quad P_{ISDN_dBm} = 13,5 \text{ dBm}$ $P_{floor} = \left(10^{P_{floor_dBm}/10}\right) / 1000 \quad [W/Hz], \quad P_{floor_dBm} = -125 \text{ dBm/Hz}$ $f_0 = 120 \text{ kHz}; \quad f_{P1} = 1\,020 \text{ kHz}; \quad f_{P2} = 1\,860 \text{ kHz}; \quad f_{L1} = 80 \text{ kHz}; \quad f_{L2} = 1\,020 \text{ kHz};$ $\text{sinc}(x) = \sin(\pi \cdot x) / (\pi \cdot x)$

Expression 2: PSD template for modelling "ISDN.MMS43" signals

4.6 Transmitter signal model for "ISDN.MMS43/filtered"

When ISDN signals have to pass a low-pass filter (such as in an ADSL splitter) before they reach the line, the disturbance caused by these ISDN systems to other wire pairs will change, as well as their performance. SpM studies should therefore make a distinction between crosstalk generated from ISDN systems connected directly to the line and filtered ISDN systems.

The PSD template for modelling a "ISDN.MMS43/filtered" transmitter signal that has passed a low-pass splitter/filter, is defined in table 4 in terms of break frequencies. It has been constructed from the transmitter PSD template, filtered by the low-pass transfer function representing the splitter/filter.

The values are based on filter assumptions according to splitter specifications in TS 101 952-1-3 [i.14] and in TS 101 952-1-4 [i.15]. The associated values are constructed with straight lines between these break frequencies, when plotted against a *logarithmic* frequency scale and a *linear* dBm scale.

Table 4: PSD template for modelling "ISDN.MMS.43/filtered" signals

ISDN.MMS.43/filtered f [Hz]	(150 Ω) PSD [dBm/Hz]
1 k	-34,5
10 k	-34,6
20 k	-35,0
30 k	-35,7
40 k	-36,7
50 k	-38,2
60 k	-40,2
70 k	-42,8
80 k	-46,2
90 k	-50,8
100 k	-56,8
110 k	-66,8
115 k	-80,3
120 k	-93,6
125 k	-106,9
130 k	-112,4
135 k	-122,5
140 k	-131,4
150 k	-130,4
170 k	-129,8
190 k	-132,7
200 k	-134,8
210 k	-137,6
216 k	-140,0
30 M	-140,0

4.7 Line-shared signal model for "ISDN.MMS43"

The PSD template for modelling the line-shared signal from an ISDN.MMS43 transmitter (also known as vv ISDN.4B3T), that has passed the low-pass and the high-pass part of a splitter/filter for sharing the line with ADSL signals, is defined in table 5 in terms of break frequencies. It has been constructed from the transmitter PSD template, filtered by the low-pass and the high-pass transfer function representing the splitter/filter.

The values are based on filter assumptions according to splitter specifications in TS 101 952-1-3 [i.14] and in TS 101 952-1-4 [i.15]. The associated values are constructed with straight lines between these break frequencies, when plotted against a *logarithmic* frequency scale and a *linear* dBm scale.

Table 5: PSD template for modelling line shared "ISDN.MMS.43" signals

Line-shared ISDN.MMS.43	(150 Ω)
f [Hz]	PSD [dBm/Hz]
1 k	-42,5
10 k	-42,6
20 k	-42,9
30 k	-43,4
40 k	-44,2
50 k	-45,3
60 k	-46,8
70 k	-48,9
80 k	-51,7
90 k	-55,3
100 k	-60,6
110 k	-70,1
115 k	-83,0
120 k	-96,0
125 k	-109,1
130 k	-114,3
135 k	-124,0
140 k	-132,7
150 k	-131,5
170 k	-130,8
190 k	-133,7
200 k	-135,8
210 k	-138,6
216 k	-140,0
30 M	-140,0

4.8 Transmitter signal model for "HDSL.2B1Q"

The PSD templates for modelling the spectra of various "HDSL.2B1Q" transmitters are defined by the theoretical sinc-shape of PAM encoded signals, with additional filtering and a noise floor. The PSD template is the maximum of both power density curves, as summarized in expression 3 and associated table 6.

The coefficient q_N scales the total signal power of $P_1(f)$ to a value that equals P_0 . This value is dedicated to the filter characteristics used, but equals $q_N=1$ when no filtering is applied ($f_L \rightarrow 0, f_H \rightarrow \infty$). The source impedance equals 135 Ω.

$$P_1(f) = P_{HDSL} \times \frac{2 \times q_N}{f_X} \times \text{sinc}^2\left(\frac{f}{f_X}\right) \times \frac{1}{1 + \left(\frac{f_L}{f}\right)^2} \times \frac{1}{1 + \left(\frac{f}{f_{H1}}\right)^{2 \cdot N_{H1}}} \times \frac{1}{1 + \left(\frac{f}{f_{H2}}\right)^{2 \cdot N_{H2}}} \quad [W / Hz]$$

$$P_2(f) = \frac{10^{(P_{\text{floor_dBm}}/10)}}{1000} \quad [W / Hz]$$

$$P(f) = \max(P_1(f), P_2(f)) \quad [W / Hz]$$

Where:

$$P_{HDSL} = \left(10^{P_{HDSL_dBm}/10}\right) / 1000 \quad [W]$$

$$R_S = 135 \quad [\Omega]$$

$$\text{sinc}(x) = \sin(\pi \cdot x) / (\pi \cdot x)$$

Default values for remaining parameters are summarized in table 6.

Expression 3: PSD template for modelling "HDSL.2B1Q" signals

Different HDSL implementations, may use different filter characteristics, and noise floor values. Table 6 summarizes *default* values for modelling HDSL transmitters (name starting with a "D"), as well as *alternative* values (name starting with an "A"). The power level P_{HDSL} equals the maximum power allowed by the HDSL standard (TS 101 135 [i.4]), since a nominal value does not exist in that standard. The noise floor P_{floor} equals a value observed for various implementations of HDSL.2B1Q/2, and assumed to be valid for other HDSL.2B1Q variants too.

Table 6: Parameter values for the HDSL.2B1Q templates, as defined in expression 3

Model	Type	f_x kHz	f_L kHz	f_{H1}	N_{H1}	f_{H2}	N_{H2}	q_N	$P_{\text{HDSL_dBm}}$ dBm	$P_{\text{floor_dBm}}$ dBm/Hz
D1	HDSL.2B1Q/1	1 160	3	$0,42 \times f_x$	3	N/A	N/A	1,4662	14	-133
D2	HDSL.2B1Q/2	584	3	$0,68 \times f_x$	4	N/A	N/A	1,1915	14	-133
A2.1	HDSL.2B1Q/2	584	3	$0,50 \times f_x$	3	N/A	N/A	1,3501	14	-133
A2.2	HDSL.2B1Q/2	584	3	$0,68 \times f_x$	4	$1,50 \times f_x$	2	1,1965	14	-133
D3	HDSL.2B1Q/3	392	3	$0,50 \times f_x$	3	N/A	N/A	1,3642	14	-133
NOTE:	The alternative values are based on higher order Butterworth filtering. Choose $f_{H2}=\infty$ and $N_{H2}=1$ when not applicable (N/A).									

NOTE: Model A2.1 assumes a minimum amount of filtering that is required to meet the transmit specifications in TS 101 135 [i.4]. Model D2 outperforms these transmit requirements by assuming the application of higher order filtering. Nevertheless, model D2 is identified as a "default" model, instead of A2.1, because it has been demonstrated that several commonly used chipsets have implemented this additional filtering. When spectral compatibility studies show that model D2 is significantly friendlier to other systems in the cable than model A2.1, it is recommended to verify that model D2 is adequate for the HDSL modem under study.

4.9 Transmitter signal model for "HDSL.CAP"

The PSD templates for modelling signals generated by HDSL.CAP transmitters are different for single-pair and two-pair HDSL systems. The PSD templates for modelling the "HDSL.CAP/1" transmit spectra for one-pair systems and "HDSL.CAP/2" transmit spectra for two-pair systems are defined in terms of break frequencies, as summarized in table 7. These templates are taken from the nominal shape of the transmit signal spectra, as specified in the ETSI HDSL standard (TS 101 135 [i.4]).

The associated values are constructed with straight lines between these break frequencies, when plotted against a *logarithmic* frequency scale and a *linear* dBm scale. The source impedance equals $R_s = 135 \Omega$.

Table 7: PSD template values at break frequencies for modelling "HDSL.CAP"

HDSL.CAP/1		HDSL.CAP/2	
1-pair 135 Ω		2-pair 135 Ω	
[Hz]	[dBm/Hz]	[Hz]	[dBm/Hz]
1	-57	1	-57
4,0 k	-57	3,98 k	-57
33 k	-43	21,5 k	-43
62 k	-40	39,02 k	-40
390,67 k	-40	237,58 k	-40
419,67 k	-43	255,10 k	-43
448,67 k	-60	272,62 k	-60
489,02 k	-70	297,00 k	-70
1 956,08 k	-120	1,188 M	-120
30 M	-120	30 M	-120
NOTE:	The out-of-band values may be lower than specified in these models.		

4.10 Transmitter signal model for "SDSL"

The PSD templates for modelling the spectra of "SDSL" transmitters are defined by the theoretical sinc-shape of PAM encoded signals, plus additional filtering and a noise floor. The transmit spectrum is defined as summarized in expression 4 and the associated table 8.

NOTE: These models are applicable to SDSL 16-UC-PAM at rates up to 2,312 Mb/s.

This PSD template is taken from the nominal shape of the transmit signal spectrum, as specified in the ETSI SDSL standard (TS 101 524 [i.5]). The source impedance equals $R_s=135 \Omega$.

$P_{sinc}(f) = \frac{K_{sdsl}}{R_s \times f_x} \times \text{sinc}^2\left(\frac{f}{f_x}\right) \times \frac{1}{1 + \left(\frac{f}{f_H}\right)^{2 \cdot N_H}} \times \frac{1}{1 + \left(\frac{f_L}{f}\right)^2} \quad [W / Hz]$
$P_{floor}(f) = \frac{10^{(P_{floor_dBm}/10)}}{1000} \quad [W / Hz]$
$P_{SDSL}(f) = P_{sinc} + P_{floor} \quad [W / Hz]$
$R_s = 135 \Omega$ $P_{floor} = -120 \text{ dBm/Hz}$ $\text{sinc}(x) = \sin(\pi \cdot x) / (\pi \cdot x)$ <i>Parameter values are defined in table 8</i>

Expression 4: PSD template values for modelling both the symmetric and asymmetric modes of SDSL

Table 8: Parameter values for the SDSL templates, as defined in expression 4

Mode	Data Rate R [kb/s]	TRA	Symbol Rate f_{sym} [kbaud]	f_x	f_H	f_L [kHz]	N_H	K_{SDSL} [V ²]
Sym	< 2 048	both	$(R+ 8 \text{ kbit/s})/3$	f_{sym}	$f_x/2$	5	6	7,86
Sym	$\geq 2 048$	both	$(R+ 8 \text{ kbit/s})/3$	f_{sym}	$f_x/2$	5	6	9,90
Asym	2 048	LTU	$(R+ 8 \text{ kbit/s})/3$	$2 \times f_{sym}$	$f_x \times 2/5$	5	7	16,86
Asym	2 048	NTU	$(R+ 8 \text{ kbit/s})/3$	f_{sym}	$f_x \times 1/2$	5	7	15,66
Asym	2 304	LTU	$(R+ 8 \text{ kbit/s})/3$	$2 \times f_{sym}$	$f_x \times 3/8$	5	7	12,48
Asym	2 304	NTU	$(R+ 8 \text{ kbit/s})/3$	f_{sym}	$f_x \times 1/2$	5	7	11,74

Power back-off (both directions)

The SDSL transmitter signal model includes a mechanism to cutback the power for short loops, and will be activated when the "Estimated Power Loss" (EPL) of the loop is below a threshold loss PL_{thres} . This EPL is defined as the ratio between the total transmitted power (in W), and the total received power (in W). This loss is usually expressed in dB as EPL_{dB} .

This power back-off (PBO) is equal for all in-band transmit frequencies, and is specified in expression 5. It should be noted that this model is based on a smooth cutback mechanism, although practical SDSL modems may cut back their power in discrete steps ("staircase"). This expression is simplified for simulation purposes. The SDSL power back-off is described in TS 101 524 [i.5], clause 9.2.6.

$$PBO_{dB} = \begin{cases} 0dB & (if \ \Delta_{PL} < 0) \\ \Delta_{PL} & (if \ 0 \leq \Delta_{PL} \leq 6dB) \\ 6dB & (if \ \Delta_{PL} > 6dB) \end{cases} \quad \text{where } \Delta_{PL} = (PL_{thres,dB} - EPL_{dB})$$

Expression 5: Power back-off of the transmitted signal (in both directions), as a function of the Estimated Power Loss (EPL) and a threshold loss of $PL_{thres,dB} = 6,5 \text{ dB}$, and represents some average of the "staircase"

4.11 Transmitter signal model for "ADSL/POTS (FO)"

The PSD template for modelling the "ADSL/POTS (FO)" (TS 101 388 [i.7]) transmit spectrum (a variant with frequency overlapping, previously referred to as Echo Cancelled) is defined in terms of break frequencies, as summarized in table 9. The associated values are constructed with straight lines between these break frequencies, when plotted against a *logarithmic* frequency scale and a *linear* dBm scale. The frequency Δf in this table refers to the spacing of the DMT sub carriers of ADSL. The source impedance equals $R_s = 100 \Omega$.

NOTE: These models do not apply to the associated ADSL2 (annex A) variant (ITU-T Recommendation G.992.3 [i.9]).

Table 9: PSD template values at break frequencies for modelling "ADSL/POTS (FO)"

ADSL/POTS (FO) DMT carriers	Up [7:31]	ADSL/POTS (FO) DMT carriers	Down [7:255]
f [Hz]	PSD [dBm/Hz]	f [Hz]	PSD [dBm/Hz]
0	-101	0	-101
3,99k	-101	3,99 k	-101
4 k	-96	4 k	-96
$6,5 \times \Delta f (\approx 28,03 \text{ k})$	-38	$6,5 \times \Delta f (\approx 28,03 \text{ k})$	-40
$31,5 \times \Delta f (\approx 135,84 \text{ k})$	-38	$256 \times \Delta f (= 1\,104 \text{ k})$	-40
$53,0 \times \Delta f (\approx 228,56 \text{ k})$	-90	1,250 M	-45
686 k	-100	1,500 M	-70
1,411 M	-100	2,100 M	-90
1,630 M	-110	3,093 M	-90
5,275 M	-112	4,545 M	-112
30 M	-112	30 M	-112
$\Delta f = 4,3125 \text{ kHz}$		$\Delta f = 4,3125 \text{ kHz}$	

Power cut back (downstream only)

The transmitter signal model includes a mechanism to cut-back the power for short loops, and will be activated when the band-limited power P_{rec} , received within a specified frequency band at the other side of the loop, exceeds a threshold value P_{thres} . This frequency band is from $6,5 \times \Delta f$ to $18,5 \times \Delta f$, where $\Delta f = 4,3125 \text{ kHz}$, and covers 12 consecutive sub carriers (7 through 18).

The cut back mechanism reduces the PSD template to a level PSD_{max} , as specified in expression 6, for those frequencies where the downstream PSD template exceeds this level. For all other frequencies, the PSD template remains unchanged. Note that this model is based on a smooth cutback mechanism, although practical ADSL modems may cut back their power in discrete steps ("staircase").

$$PSD_{max,dBm} = \begin{cases} -40dBm/Hz & (if \Delta_p < 0dB) \\ -40dBm/Hz - 2 \times \Delta_p & (if 0 \leq \Delta_p \leq 6dB) \\ -52dBm/Hz & (if \Delta_p > 6dB) \end{cases} \quad \text{where } \Delta_p = (P_{rec,dBm} - P_{thres,dBm})$$

Expression 6: Maximum PSD values of the transmitted downstream signal, as a function of the band-limited received power P_{rec} and a threshold level of $P_{thres,dBm} = 2,5 \text{ dBm}$, and represents some average of the "staircase"

4.12 Transmitter signal model for "ADSL/POTS (FDD)"

The PSD template for modelling "ADSL/POTS (FDD)" (TS 101 388 [i.7] and ITU-T Recommendation G.992.1 [i.8]) transmit spectra (variants with frequency division duplexing) is defined in terms of break frequencies, as summarized in tables 11 and 10.

- Table 10 is to be used for modelling "adjacent FDD modems", usually enhanced by echo cancellation for improving the separation between upstream and downstream signals. Because a guard band is not needed here, only 1 sub-carrier is left unused.

- Table 11 is to be used for modelling "guard band FDD modems", usually equipped with steep filtering for improving the separation between upstream and downstream signals. 7 sub-carriers are left unused to enable this guard band to be implemented.

The associated values are constructed with straight lines between these break frequencies, when plotted against a *logarithmic* frequency scale and a *linear* dBm scale. The frequency Δf in this table refers to the spacing of the DMT sub-carriers of ADSL. The source impedance equals $R_s = 100 \Omega$.

NOTE: These models do not apply to the associated ADSL2 (annex A) variant (ITU-T Recommendation G.992.3 [i.9]).

Table 10: PSD template values at break frequencies for modelling "ADSL/POTS (FDD)", implemented as "adjacent FDD" (with echo cancelling)

Adjacent FDD (using echo cancellation)			
ADSL/POTS (FDD) DMT carriers	Up [7:31]	ADSL/POTS (FDD) DMT carriers	Down [33:255]
f [Hz]	PSD [dBm/Hz]	f [Hz]	PSD [dBm/Hz]
0	-101	0	-101
3,99k	-101	3,99 k	-101
4 k	-96	4 k	-96
6,5 $\times\Delta f$ ($\approx 28,03$ k)	-38	22,5 $\times\Delta f$ ($\approx 97,03$ k)	-96
31,5 $\times\Delta f$ ($\approx 135,84$ k)	-38	32,0 $\times\Delta f$ ($\approx 138,00$ k)	-47,7
41,5 $\times\Delta f$ ($\approx 178,97$ k)	-90	32,5 $\times\Delta f$ ($\approx 140,16$ k)	-40
686 k	-100	256 $\times\Delta f$ (= 1 104 k)	-40
1,411 M	-100	1,250 M	-45
1,630 M	-110	1,500 M	-70
5,275 M	-112	2,100 M	-90
30 M	-112	3,093 M	-90
		4,545 M	-112
		30 M	-112
$\Delta f = 4,3125$ kHz		$\Delta f = 4,3125$ kHz	

NOTE: This PSD allocates 1 unused sub carrier, since a guard band is not required here.

Table 11: PSD template values at break frequencies for modelling "ADSL/POTS (FDD)", implemented as "guard band FDD" (with filtering)

Guard band FDD (using filters)			
ADSL/POTS (FDD) DMT carriers	Up [7:30]	ADSL/POTS (FDD) DMT carriers	Down [38:255]
f [Hz]	PSD [dBm/Hz]	f [Hz]	PSD [dBm/Hz]
0	-101	0	-101
3,99k	-101	3,99 k	-101
4 k	-96	4 k	-96
6,5 $\times\Delta f$ ($\approx 28,03$ k)	-38	27,5 $\times\Delta f$ ($\approx 118,59$ k)	-96
30,5 $\times\Delta f$ ($\approx 131,53$ k)	-38	37,0 $\times\Delta f$ ($\approx 159,56$ k)	-47,7
40,5 $\times\Delta f$ ($\approx 174,66$ k)	-90	37,5 $\times\Delta f$ ($\approx 161,72$ k)	-40
686 k	-100	256 $\times\Delta f$ (= 1 104 k)	-40
1,411 M	-100	1,250 M	-45
1,630 M	-110	1,500 M	-70
5,275 M	-112	2,100 M	-90
30 M	-112	3,093 M	-90
		4,545 M	-112
		30 M	-112
$\Delta f = 4,3125$ kHz		$\Delta f = 4,3125$ kHz	

NOTE: This PSD allocates 7 unused sub-carriers.

Power cut back (downstream only)

The transmitter signal model includes a mechanism to cut back the power for short loops, using the same mechanism as specified in expression 6, for modelling "ADSL/POTS (FO)" transmitters.

4.13 Transmitter signal model for "ADSL/ISDN (FO)"

The PSD template for modelling the "ADSL/ISDN (FO)" (TS 101 388 [i.7] and ITU-T Recommendation G.992.1 [i.8]) transmit spectrum (a variant with frequency overlapping, previously referred to as Echo Cancelled) is defined in terms of break frequencies, as summarized in table 12. The associated values are constructed with straight lines between these break frequencies, when plotted against a *logarithmic* frequency scale and a *linear* dBm scale. The frequency Δf in this table refers to the spacing of the DMT sub-carriers of ADSL. The source impedance equals $R_s = 100 \Omega$.

NOTE: These models do not apply to the associated ADSL2 (annex B) variant (ITU-T Recommendation G.992.3 [i.9]).

Table 12: PSD template values at break frequencies for modelling "ADSL/ISDN (FO)"

ADSL/ISDN (FO) DMT carriers	Up [33:63]	ADSL/ISDN (FO) DMT carriers	Down [33:255]
f [Hz]	PSD [dBm/Hz]	f [Hz]	PSD [dBm/Hz]
0	-90	0	-90
50	-90	50 k	-90
22,5 $\times\Delta f$ ($\approx 97,03$ k)	-85,3	22,5 $\times\Delta f$ ($\approx 97,03$ k)	-85,3
32,5 $\times\Delta f$ ($\approx 140,16$ k)	-38	32,5 $\times\Delta f$ ($\approx 140,16$ k)	-40
63,5 $\times\Delta f$ ($\approx 273,84$ k)	-38	256 $\times\Delta f$ ($\approx 1\,104$ k)	-40
67,5 $\times\Delta f$ ($\approx 291,09$ k)	-55	1,250 M	-45
74,5 $\times\Delta f$ ($\approx 321,28$ k)	-60	1,500 M	-70
80,5 $\times\Delta f$ ($\approx 347,16$ k)	-97,8	2,100 M	-90
686 k	-100	3,093 M	-90
1,411 M	-100	4,545 M	-112
1,630 M	-110	30 M	-112
5,275 M	-112		
30 M	-112		
$\Delta f = 4,3125$ kHz		$\Delta f = 4,3125$ kHz	

Power cut back (downstream only)

The transmitter signal model includes a mechanism to cut-back the power for short loops, and will be activated when the band-limited power P_{rec} , received within a specified frequency band at the other side of the loop, exceeds a threshold value P_{thres} . This frequency band is from $35,5\times\Delta f$ to $47,5\times\Delta f$, where $\Delta f = 4,3125$ kHz, and covers 12 consecutive sub carriers (36 through 47).

The cut back mechanism reduces the PSD template to a level PSD_{max} , as specified in expression 7, for those frequencies where the downstream PSD template exceeds this level. For all other frequencies, the PSD template remains unchanged. Note that this model is based on a smooth cutback mechanism, although practical ADSL modems may cut back their power in discrete steps ("staircase").

$$PSD_{max,dBm} = \begin{cases} -40dBm/Hz & (\text{if } \Delta_p < 0dB) \\ -40dBm/Hz - \frac{4}{3} \times \Delta_p & (\text{if } 0 \leq \Delta_p \leq 9dB) \\ -52dBm/Hz & (\text{if } \Delta_p > 9dB) \end{cases} \quad \text{where } \Delta_p = (P_{rec,dBm} - P_{thres,dBm})$$

Expression 7: Maximum PSD values of the transmitted downstream signal, as a function of the band-limited received power P_{rec} and a threshold level of $P_{thres,dBm} = -0,75$ dBm, and represents some average of the "staircase"

4.14 Transmitter signal model for "ADSL/ISDN (FDD)"

The PSD template for modelling "ADSL /ISDN (FDD)" (TS 101 388 [i.7] and ITU-T Recommendation G.992.1 [i.8]) transmit spectra (variants with frequency division duplexing) is defined in terms of break frequencies, as summarized in tables 14 and 13.

- Table 13 is to be used for modelling "adjacent FDD modems", usually enhanced by echo cancellation for improving the separation between upstream and downstream signals. Because a guard band is not needed here, no sub-carrier is left unused.
- Table 14 is to be used for modelling "guard band FDD modems", usually enhanced by steep filtering for improving the separation between upstream and downstream signals. 7 sub-carriers are left unused to enable this guard band to be implemented.

The associated values are constructed with straight lines between these break frequencies, when plotted against a *logarithmic* frequency scale and a *linear* dBm scale. The frequency Δf in this table refers to the spacing of the DMT sub-carriers of ADSL. The source impedance equals $R_s = 100 \Omega$.

NOTE: These models do not apply to the associated ADSL2 (annex B) variant (ITU-T Recommendation G.992.3 [i.9]).

Table 13: PSD template values at break frequencies for modelling "ADSL/ISDN (FDD)", implemented as "adjacent FDD" (with echo cancelling)

Adjacent FDD (using echo cancellation)			
ADSL/ISDN (FDD) DMT carriers		ADSL/ISDN (FDD) DMT carriers	
<i>f</i> [Hz]	<i>Up</i> [33:63] PSD [dBm/Hz]	<i>f</i> [Hz]	<i>Down</i> [64:255] PSD [dBm/Hz]
0	-90	0	-90
50	-90	53,5× Δf (\approx 230,72 k)	-90
22,5× Δf (\approx 97,03 k)	-85,3	63,0× Δf (\approx 271,79 k)	-52
32,5× Δf (\approx 140,16 k)	-38	63,5× Δf (\approx 273,84 k)	-40
63,5× Δf (\approx 273,84 k)	-38	256× Δf (\approx 1 104 k)	-40
67,5× Δf (\approx 291,09 k)	-55	1,250 M	-45
74,5× Δf (\approx 321,28 k)	-60	1,500 M	-70
80,5× Δf (\approx 347,16 k)	-97,8	2,100 M	-90
686 k	-100	3,093 M	-90
1,411 M	-100	4,545 M	-112
1,630 M	-110	30 M	-112
5,275 M	-112		
30 M	-112		
$\Delta f = 4,3125$ kHz		$\Delta f = 4,3125$ kHz	

NOTE: This PSD has no guard band.

Table 14: PSD template values at break frequencies for modelling "ADSL/ISDN (FDD)", implemented as "guard band FDD" (with filtering)

Guard band FDD (using filters)					
ADSL/ISDN (FDD) DMT carriers		Up [33:56]	ADSL/ISDN (FDD) DMT carriers		Down [64:255]
f [Hz]		PSD [dBm/Hz]	f [Hz]		PSD [dBm/Hz]
0		-90	0		-90
50		-90	53,5×Δf (≈ 230,72 k)		-90
22,5×Δf (≈ 97,03 k)		-85,3	63,0×Δf (≈ 271,79 k)		-52
32,5×Δf (≈ 140,16 k)		-38	63,5×Δf (≈ 273,84 k)		-40
56,5×Δf (≈ 243,66 k)		-38	256×Δf (= 1 104 k)		-40
60,5×Δf (≈ 260,91 k)		-55	1,250 M		-45
67,5×Δf (≈ 291,09 k)		-60	1,500 M		-70
73,5×Δf (≈ 316,97 k)		-97,8	2,100 M		-90
686 k		-100	3,093 M		-90
1,411 M		-100	4,545 M		-112
1,630 M		-110	30 M		-112
5,275 M		-112			
30 M		-112			
Δf = 4,3125 kHz			Δf = 4,3125 kHz		

NOTE: This PSD allocates 7 unused sub-carriers.

Power cut back (downstream only)

The transmitter signal model includes a mechanism to cut back the power for short loops, using the same mechanism as specified in expression 7, for modelling "ADSL/ISDN (FO)" transmitters.

4.15 Transmitter signal model for "ADSL2/J (FDD)"

The PSD template for modelling the "ADSL2/J (FDD)" transmit spectrum is defined in terms of break frequencies, as summarized in table 15. The associated values are constructed with straight lines between these break frequencies, when plotted against a *logarithmic* frequency scale and a *linear* dBm scale. The frequency Δf in this table refers to the sub-carrier spacing of the DMT tones of ADSL. The source impedance equals 100 Ω.

Table 15: PSD template values at break frequencies for modelling "ADSL2/J (FDD)" - The values for $f_1...f_4$ and $PSD_1...PSD_3$ are specified in table 16

ADSL2/J (FDD) DMT carriers		Up [1:k]	ADSL2/J (FDD) DMT carriers		Down [64:255]
f [Hz]		PSD [dBm/Hz]	f [Hz]		PSD [dBm/Hz]
0		-50	0		-90
1,5 k		-50	53,5×Δf (≈ 230,72 k)		-90
3 k		PSD_1	63,0×Δf (≈ 271,79 k)		-52
$f_1 = k \times \Delta f$		PSD_1	63,5×Δf (≈ 273,84 k)		-40
f_2		PSD_2	256,0×Δf (= 1104,00 k)		-40
f_3		PSD_3	1,250 M		-45
f_4		-97,8	1,500 M		-70
686 k		-100	2,100 M		-90
1,411 M		-100	3,093 M		-90
1,630 M		-110	4,545 M		-112
5,275 M		-112	30 M		-112
30 M		-112			
Δf = 4,3125 kHz			Δf = 4,3125 kHz		

Table 16: Parameter values for parameters used in table 15

US mask number (M)	Tone range [1...k]	f_1 [kHz]	f_2 [kHz]	f_3 [kHz]	f_4 [kHz]	PSD_1 [dBm/Hz]	PSD_2 [dBm/Hz]	PSD_3 [dBm/Hz]
1	1...32	$32 \times \Delta f (\approx 140,16)$	153,38	157,50	192,45	-38,0	-55,0	-60,0
2	1...36	$36 \times \Delta f (\approx 157,41)$	171,39	176,46	208,13	-38,5	-55,5	-60,5
3	1...40	$40 \times \Delta f (\approx 174,66)$	189,31	195,55	224,87	-39,0	-56,0	-61,0
4	1...44	$44 \times \Delta f (\approx 191,91)$	207,16	214,87	242,51	-39,4	-56,4	-61,4
5	1...48	$48 \times \Delta f (\approx 209,16)$	224,96	234,56	260,90	-39,8	-56,8	-61,8
6	1...52	$52 \times \Delta f (\approx 226,41)$	242,70	254,84	280,25	-40,1	-57,1	-62,1
7	1...56	$56 \times \Delta f (\approx 243,66)$	260,40	276,14	300,85	-40,4	-57,4	-62,4
8	1...60	$60 \times \Delta f (\approx 260,91)$	278,05	299,30	323,55	-40,7	-57,7	-62,7
9	1...63	$63 \times \Delta f (\approx 273,84)$	291,09	321,28	345,04	-41,0	-58,0	-63,0

Power back-off

NOTE: The specification of power back-off is left for further study.

4.16 Transmitter signal model for "ADSL2/M (FDD)"

The PSD template for modelling the "ADSL2/M (FDD)" transmit spectrum is defined in terms of break frequencies, as summarized in tables 17 and 18. The associated values are constructed with straight lines between these break frequencies, when plotted against a *logarithmic* frequency scale and a *linear* dBm scale. The frequency Δf in this table refers to the sub-carrier spacing of the DMT tones of ADSL. The source impedance equals 100 Ω .

Table 17: PSD template values at break frequencies for modelling "ADSL2/M (FDD)" - The values for $f_1...f_4$ and $PSD_1...PSD_3$ are specified in table 18

ADSL2/M (FDD) DMT carriers	Up [7:k]	ADSL2/M (FDD) DMT carriers	Down [64:255]
f [Hz]	PSD [dBm/Hz]	f [Hz]	PSD [dBm/Hz]
0	-101	0	-90
3,99k	-101	$53,5 \times \Delta f (\approx 230,72 \text{ k})$	-90
4 k	-96	$63,0 \times \Delta f (\approx 271,79 \text{ k})$	-52
$6,5 \times \Delta f (\approx 28,03 \text{ k})$	PSD_1	$63,5 \times \Delta f (\approx 273,84 \text{ k})$	-40
$f_1 = k \times \Delta f$	PSD_1	$256,0 \times \Delta f (\approx 1104,00 \text{ k})$	-40
f_2	PSD_2	1,250 M	-45
f_3	PSD_3	1,500 M	-70
f_4	-97,8	2,100 M	-90
686 k	-100	3,093 M	-90
1,411 M	-100	4,545 M	-112
1,630 M	-110	30 M	-112
5,275 M	-112		
30 M	-112		
$\Delta f = 4,3125 \text{ kHz}$		$\Delta f = 4,3125 \text{ kHz}$	

Table 18: Parameter values for parameters used in table 17

US mask number (M)	Tone range [7...k]	f_1 [kHz]	f_2 [kHz]	f_3 [kHz]	f_4 [kHz]	PSD_1 [dBm/Hz]	PSD_2 [dBm/Hz]	PSD_3 [dBm/Hz]
1	7...32	$32 \times \Delta f$ ($\approx 140,16$)	153,38	157,50	192,45	-38,0	-55,0	-60,0
2	7...36	$36 \times \Delta f$ ($\approx 157,41$)	171,39	176,46	208,13	-38,5	-55,5	-60,5
3	7...40	$40 \times \Delta f$ ($\approx 174,66$)	189,31	195,55	224,87	-39,0	-56,0	-61,0
4	7...44	$44 \times \Delta f$ ($\approx 191,91$)	207,16	214,87	242,51	-39,4	-56,4	-61,4
5	7...48	$48 \times \Delta f$ ($\approx 209,16$)	224,96	234,56	260,90	-39,8	-56,8	-61,8
6	7...52	$52 \times \Delta f$ ($\approx 226,41$)	242,70	254,84	280,25	-40,1	-57,1	-62,1
7	7...56	$56 \times \Delta f$ ($\approx 243,66$)	260,40	276,14	300,85	-40,4	-57,4	-62,4
8	7...60	$60 \times \Delta f$ ($\approx 260,91$)	278,05	299,30	323,55	-40,7	-57,7	-62,7
9	7...63	$63 \times \Delta f$ ($\approx 273,84$)	291,09	321,28	345,04	-41,0	-58,0	-63,0

Power back-off

NOTE: The specification of power back-off is left for further study.

4.17 Transmitter signal model for "VDSL1"

VDSL1 is defined for a range of scenarios, each with its own template PSD. The ETSI VDSL1 standard (TS 101 270-1 [i.11]) has foreseen the various pairs of PSD templates for upstream and downstream transceivers, as summarized in tables 19 to 22.

The PSD template for modelling each of these "VDSL1" transmit spectra, is defined in terms of break frequencies, as specified in tables 23 to 26 and in tables 27 to 30. The associated values are constructed with straight lines between these break frequencies, when plotted against a *logarithmic* frequency scale and a *linear* dBm scale. The source impedance is equal to the selected design impedance, and can be $R_V = 135 \Omega$ or $R_V = 100 \Omega$.

NOTE: The templates below do not take into account that additional PSD reduction mechanisms like pre-defined downstream PSD limitation or automatic upstream power back-off can be applied in a practical situation. For the downstream signals of FTTEx-VDSL1, and for the downstream signals of FTTCab-VDSL1 M2 (variant A and B), the transmitter is not allowed to fill the complete PSD mask, because it violates the maximum transmit power allowed. The transmitter has then to reduce the PSD, until the power constraint is fulfilled. This reduction mechanism is not specified in the VDSL1 standard. The templates below are based on a specific modem power reduction method using the ceiling power cutback. The actual transmit PSD could therefore differ from one modem to the other.

Table 19: VDSL1/Cab - ETSI main bandplan (also known as 997)

	up	down	comment
1	E1::P.M1.withoutUS0	E1::Pcab.M1.A	Main plan, non-boosted, DS above 1 104 kHz
2	E1::P.M1.withoutUS0	E1::Pcab.M1.B	Main plan, non-boosted, DS above 958 kHz
3	E1::P.M1.withUS0	E1::Pcab.M1.A	Main plan, non-boosted, DS above 1 104 kHz
4	E1::P.M1.withUS0	E1::Pcab.M1.B	Main plan, non-boosted, DS above 958 kHz
5	E1::P.M2.withoutUS0	E1::Pcab.M2.A	Main plan, boosted, DS above 1 104 kHz
6	E1::P.M2.withoutUS0	E1::Pcab.M2.B	Main plan, boosted, DS above 958 kHz
7	E1::P.M2.withUS0	E1::Pcab.M2.A	Main plan, boosted, DS above 1 104 kHz
8	E1::P.M2.withUS0	E1::Pcab.M2.B	Main plan, boosted, DS above 958 kHz

Table 20: VDSL1/Ex - ETSI main bandplan (also known as 997)

	up	DS	comment
1	E1::P.M1.withoutUS0	E1::Pex.P1.M1	Main plan, non-boosted, DS above 251 kHz
2	E1::P.M1.withoutUS0	E1::Pex.P2.M1	Main plan, non-boosted, DS above 138 kHz
3	E1::P.M1.withUS0	E1::Pex.P1.M1	Main plan, non-boosted, DS above 251 kHz
4	E1::P.M1.withUS0	E1::Pex.P2.M1	Main plan, non-boosted, DS above 138 kHz
5	E1::P.M2.withoutUS0	E1::Pex.P1.M2	Main plan, boosted, DS above 251 kHz
6	E1::P.M2.withoutUS0	E1::Pex.P2.M2	Main plan, boosted, DS above 138 kHz
7	E1::P.M2.withUS0	E1::Pex.P1.M2	Main plan, boosted, DS above 251 kHz
8	E1::P.M2.withUS0	E1::Pex.P2.M2	Main plan, boosted, DS above 138 kHz

Table 21: VDSL1/Cab - ETSI optional bandplan (also known as 998)

	up	DS	comment
1	E2::P.M1.withoutUS0	E2::Pcab.M1.A	Optional plan, non-boosted, DS above 1 104 kHz
2	E2::P.M1.withoutUS0	E2::Pcab.M1.B	Optional plan, non-boosted, DS above 958 kHz
3	E2::P.M1.withUS0	E2::Pcab.M1.A	Optional plan, non-boosted, DS above 1 104 kHz
4	E2::P.M1.withUS0	E2::Pcab.M1.B	Optional plan, non-boosted, DS above 958 kHz
5	E2::P.M2.withoutUS0	E2::Pcab.M2.A	Optional plan, boosted, DS above 1 104 kHz
6	E2::P.M2.withoutUS0	E2::Pcab.M2.B	Optional plan, boosted, DS above 958 kHz
7	E2::P.M2.withUS0	E2::Pcab.M2.A	Optional plan, boosted, DS above 1 104 kHz
8	E2::P.M2.withUS0	E2::Pcab.M2.B	Optional plan, boosted, DS above 958 kHz

Table 22: VDSL1/Ex - ETSI optional bandplan (also known as 998)

	up	DS	comment
1	E2::P.M1.withoutUS0	E2::Pex.P1.M1	Optional plan, non-boosted, DS above 251 kHz
2	E2::P.M1.withoutUS0	E2::Pex.P2.M1	Optional plan, non-boosted, DS above 138 kHz
3	E2::P.M1.withUS0	E2::Pex.P1.M1	Optional plan, non-boosted, DS above 251 kHz
4	E2::P.M1.withUS0	E2::Pex.P2.M1	Optional plan, non-boosted, DS above 138 kHz
5	E2::P.M2.withoutUS0	E2::Pex.P1.M2	Optional plan, boosted, DS above 251 kHz
6	E2::P.M2.withoutUS0	E2::Pex.P2.M2	Optional plan, boosted, DS above 138 kHz
7	E2::P.M2.withUS0	E2::Pex.P1.M2	Optional plan, boosted, DS above 251 kHz
8	E2::P.M2.withUS0	E2::Pex.P2.M2	Optional plan, boosted, DS above 138 kHz

Power back-off

<FOR FURTHER STUDY>

4.17.1 Templates compliant with the ETSI main band plan

Table 23: Default US PSD templates

E1::P.M1		E1::P.M2	
Frequency [kHz]	Template [dBm/Hz]	Frequency [kHz]	Template [dBm/Hz]
With optional band			
0	-110	0	-110
4	-110	4	-110
25	-40	25	-40
138	-40	138	-40
307	-90	307	-90
482	-100	482	-100
Without optional band			
0	-110	0	-110
225	-110	225	-110
226	-100	226	-100
Common PSD			
2 825	-100	2 825	-100
3 000	-80	3 000	-80
3 001	-61	3 001	-54,8
5 099	-61	5 099	-57,1
5 100	-82	5 100	-82
5 274	-102	5 274	-102
5 275	-112	5 275	-112
6 875	-112	6 875	-112
6 876	-102	6 876	-102
7 050	-82	7 050	-82
7 051	-61	7 051	-58,5
11 999	-61	10 000	-60
12 000	-82	11 999	-60
12 175	-102	12 000	-82
12 176	-112	12 175	-102
30 000	-112	12 176	-112
		30 000	-112

Table 24: Default DS FTTCab PSD templates

E1::Pcab.M1		E1::Pcab.M2	
Frequency [kHz]	Template [dBm/Hz]	Frequency [kHz]	Template [dBm/Hz]
Variant A			
0	-110	0	-110
225	-110	225	-110
226	-100	226	-100
929	-100	929	-100
1 104	-80	1 104	-80
Variant B			
0	-110	0	-110
225	-110	225	-110
226	-100	226	-100
770	-100	770	-100
945	-80	945	-80
946	-78,3	946	-77,3
947,2	-74,8	947,2	-73,8
949	-72	949	-71
958	-67,1	958	-66,1
1 104	-61	1 104	-60
Common			
1 105	-61	1 105	-60
2 999	-61	1 394	-51,4
3 000	-82	2 999	-54,8
3 174	-102	3 000	-82
3 175	-110	3 174	-102
4 925	-110	3 175	-110
4 926	-102	4 925	-110
5 100	-82	4 926	-102
5 101	-61	5 100	-82
7 049	-61	5 101	-57,1
7 050	-82	7 049	-58,5
7 224	-102	7 050	-82
7 225	-112	7 224	-102
30 000	-112	7 225	-112
		30 000	-112

Table 25: Default DS FTTEEx P1 PSD templates

E1::Pex.P1.M1		E1::Pex.P1.M2	
Frequency [kHz]	Template [dBm/Hz]	Frequency [kHz]	Template [dBm/Hz]
0	-97,5	0	-97,5
3,99	-97,5	3,99	-97,5
4	-90	4	-90
138	-90	138	-90
139	-61	139	-61
217	-61	217	-61
256	-46,4	251	-48,2
1 254	-46,4	1 303	-48,2
1 677	-61	1 394	-51,4
2 999	-61	2 999	-54,8
3 000	-82	3 000	-82
3 174	-102	3 174	-102
3 175	-110	3 175	-110
4 925	-110	4 925	-110
4 926	-102	4 926	-102
5 100	-82	5 100	-82
5 101	-61	5 101	-57,1
7 049	-61	7 049	-58,5
7 050	-82	7 050	-82
7 224	-102	7 224	-102
7 225	-112	7 225	-112
30 000	-112	30 000	-112

Table 26: Default DS FTTEEx P2 PSD templates

E1::Pex.P2.M1		E1::Pex.P2.M2	
Frequency [kHz]	Template [dBm/Hz]	Frequency [kHz]	Template [dBm/Hz]
0	-97,5	0	-97,5
3,99	-97,5	3,99	-97,5
4	-90	4	-90
138	-90	138	-90
139	-46,9	139	-48,5
1 265	-46,9	1 314	-48,5
1 677	-61	1 394	-51,4
2 999	-61	2 999	-54,8
3 000	-82	3 000	-82
3 174	-102	3 174	-102
3 175	-110	3 175	-110
4 925	-110	4 925	-110
4 926	-102	4 926	-102
5 100	-82	5 100	-82
5 101	-61	5 101	-57,1
7 049	-61	7 049	-58,5
7 050	-82	7 050	-82
7 224	-102	7 224	-102
7 225	-112	7 225	-112
30 000	-112	30 000	-112

4.17.2 Templates compliant with the ETSI optional band plan

Table 27: Optional US PSD templates

E2::P.M1		E2::P.M2	
Frequency [kHz]	Template [dBm/Hz]	Frequency [kHz]	Template [dBm/Hz]
With optional band			
0	-110	0	-110
4	-110	4	-110
25	-40	25	-40
138	-40	138	-40
307	-90	307	-90
Without optional band			
0	-110	0	-110
225	-110	225	-110
226	-100	226	-100
Common PSD			
482	-100	482	-100
3 575	-100	3 575	-100
3 750	-80	3 750	-80
3 751	-61	3 751	-55,7
5 199	-61	5 199	-57,2
5 200	-82	5 200	-82
5 374	-102	5 374	-102
5 375	-112	5 375	-112
8 325	-112	8 325	-112
8 326	-102	8 326	-102
8 500	-82	8 500	-82
8 501	-61	8 501	-59,3
11 999	-61	10 000	-60
12 000	-82	11 999	-60
12 175	-102	12 000	-82
12 176	-112	12 175	-102
30 000	-112	12 176	-112
		30 000	-112

Table 28: Optional DS FTTCab PSD templates

E2::Pcab.M1		E2::Pcab.M2	
Frequency [kHz]	Template [dBm/Hz]	Frequency [kHz]	Template [dBm/Hz]
Variant A			
0	-110	0	-110
225	-110	225	-110
226	-100	226	-100
929	-100	929	-100
1 104	-80	1 104	-80
Variant B			
0	-110	0	-110
225	-110	225	-110
226	-100	226	-100
770	-100	770	-100
945	-80	945	-80
946	-78,3	946	-77,3
947,2	-74,8	947,2	-73,8
949	-72	949	-71
958	-67,1	958	-66,1
1 104	-61	1 104	-60
Common			
1 105	-61	1 105	-60
3 749	-61	1 295	-54,1
3 750	-82	2 603	-54,1
3 924	-102	3 749	-55,7
3 925	-110	3 750	-82
5 025	-110	3 924	-102
5 026	-102	3 925	-110
5 200	-82	5 025	-110
5 201	-61	5 026	-102
8 499	-61	5 200	-82
8 500	-82	5 201	-57,2
8 674	-102	8 499	-59,3
8 675	-112	8 500	-82
30 000	-112	8 674	-102
		8 675	-112
		30 000	-112

Table 29: Optional DS FTTE_x P1 PSD templates

E2::Pex.P1.M1		E2::Pex.P1.M2	
Frequency [kHz]	Template [dBm/Hz]	Frequency [kHz]	Template [dBm/Hz]
0	-97,5	0	-97,5
3,99	-97,5	3,99	-97,5
4	-90	4	-90
138	-90	138	-90
139	-61	139	-61
217	-61	217	-61
255	-46,8	248	-49,4
1 262	-46,8	1 336	-49,4
1 677	-61	1 394	-51,4
3 749	-61	3 749	-55,7
3 750	-82	3 750	-82
3 924	-102	3 924	-102
3 925	-110	3 925	-110
5 025	-110	5 025	-110
5 026	-102	5 026	-102
5 200	-82	5 200	-82
5 201	-61	5 201	-57,2
8 499	-61	8 499	-59,3
8 500	-82	8 500	-82
8 674	-102	8 674	-102
8 675	-112	8 675	-112
30 000	-112	30 000	-112

Table 30: Optional DS FTTE_x P2 PSD templates

E2::Pex.P2.M1		E2::Pex.P2.M2	
Frequency [kHz]	Template [dBm/Hz]	Frequency [kHz]	Template [dBm/Hz]
0	-97,5	0	-97,5
3,99	-97,5	3,99	-97,5
4	-90	4	-90
138	-90	138	-90
139	-47,2	139	-49,7
1 273	-47,2	1 346	-49,7
1 677	-61	1 394	-51,4
3 749	-61	3 749	-55,7
3 750	-82	3 750	-82
3 924	-102	3 924	-102
3 925	-110	3 925	-110
5 025	-110	5 025	-110
5 026	-102	5 026	-102
5 200	-82	5 200	-82
5 201	-61	5 201	-57,2
8 499	-61	8 499	-59,3
8 500	-82	8 500	-82
8 674	-102	8 674	-102
8 675	-112	8 675	-112
30 000	-112	30 000	-112

4.18 Transmitter signal models for "VDSL2"

The PSD templates for VDSL2 are to model the VDSL variants being defined in ITU T recommendation G993.2 [i.13].

The complexity of VDSL2 (many flavours, many kinds of PSD shaping/PBO in downstream and upstream, power restrictions) requires a break-down of the specification of a PSD template for a particular scenario. Figure 1 illustrates how the VDSL2 transmitter model can be broken down into four individual building blocks. Each block has its own set of controlling parameters, to control one or more aspects of the output spectrum of VDSL2.

- A baseline "noise floor" being defined for all frequencies of interest, as input for the first building block.
- A "PSD band constructor" that enables the bands requested by the user above this noise floor.
- A "PSD shaper" that modifies the shape of an intermediate template PSD by a parametric formula, guided by the spectrum to be protected in the downstream and by the desired received signal in the upstream.
- A "PSD Notcher" that can "punch" notches in a shaped PSD, to prevent egress levels being too high in radio bands of interest.
- A "PSD power restrictor" that can modify a PSD (template) in such a way that the aggregate power of the PSD does not exceed some pre-defined upper limit.

In addition, pre-defined tables are provided for the "PSD band constructor" to generate spectra that are compliant with those being defined in the ITU T recommendation G993.2 [i.13].

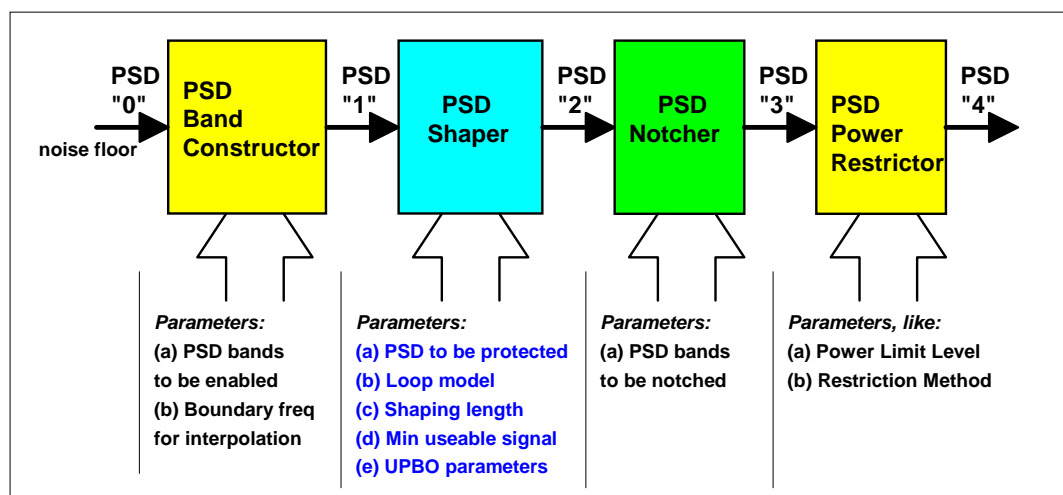

Figure 1: Building blocks of a VDSL2 transmitter model, for defining a wide range of PSD templates with only a few PSD tables and formulas

4.18.1 Noise floor

The noise floor defines a base line PSD, as input for the first building block. Suitable noise floors are pre-defined in table 31, but the model is not restricted to any of these pre-defined PSDs.

Table 31: Pre-defined noise floors, derived from clause B4.1 in G993.2 [i.13], as starting PSD for building block #1

<i>f</i> [MHz]	NF_998	NF_997	NF_HPE
	PSD [dBm/Hz]	PSD [dBm/Hz]	PSD [dBm/Hz]
0	-100	-100	-100
4 M	-100	-100	-100
4 M	-110	-110	-110
5,1 M	interp	-110	interp
5,1 M	interp	-112	interp
5,2 M	-110	interp	interp
5,2 M	-112	interp	interp
7,05 M	interp	interp	-110
7,05 M	interp	interp	-112
30 M	-112	-112	-112

4.18.2 Building block #1 for "PSD Band Constructor"

Building block #1 for the "PSD band constructor" generates a static PSD template, selected from a set of PSD bands. Pre-defined spectra are provided by means of break point tables, up to 30 MHz, but the use of the algorithmic model is not restricted to these tables.

The model in figure 2 starts from a PSD, representing a *noise floor*, and combines it subsequently with as many PSD bands as required. A pre-defined noise floor is provided as well.

Combining means within this context: taking the *maximum* of two PSD levels, where one PSD is the selected PSD band, and the other is a PSD being built-up in previous steps (starting with the noise floor). This maximum is to be evaluated for all frequencies within the selected PSD band. Outside that band, the PSD will remain unchanged.

Figure 3 visualizes such a step in reconstructing a resulting PSD from these two "input" PSDs.

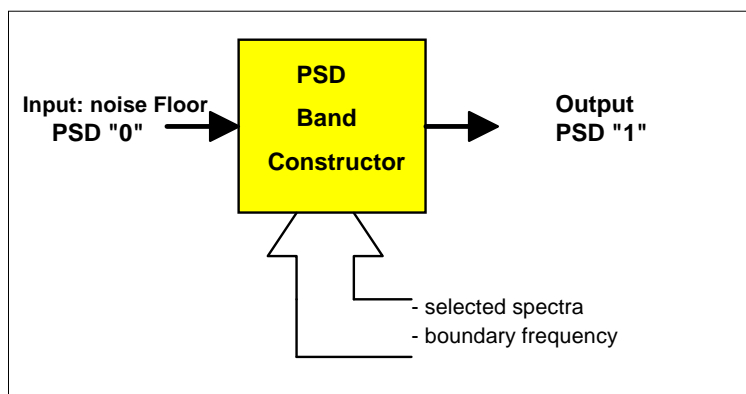

Figure 2: Conceptual description of the "PSD Band Constructor" block

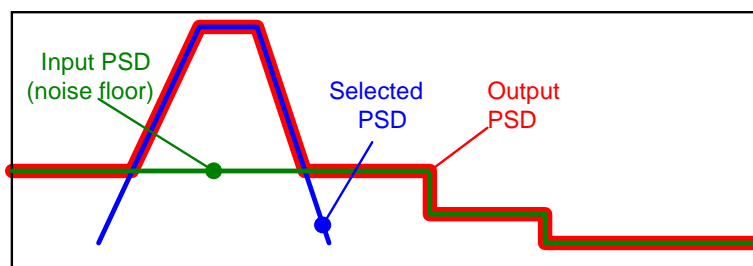

Figure 3: Illustration on how building block #1 combines two PSDs into a third

The PSD bands can have arbitrary spectra and can be defined in many ways. A commonly used approach is a PSD definition by means of break-point tables. Such a PSD is derived via interpolation, by interconnecting the breakpoints via a straight line when plotted on a linear dB scale. This is called "linear" interpolation, when plotted on a linear frequency axis, "logarithmic" interpolation, when plotted on a logarithmic axis, and "mixed" interpolation when both methods are applied in different frequency bands. When mixed interpolation applies, the boundary frequencies are to be specified as well.

For the purpose of VDSL2 modelling pre-defined PSD bands are provided by means of breakpoint tables, as specified in tables 35 to 43 (for downstream) and tables 45 to 53 (for upstream). A naming convention is summarized in table 34 (for downstream) and table 44 (for upstream). The values have been derived from ITU-T recommendation G993.2 [i.13]. Each PSD band is essentially the combination of an in-band PSD and transition PSD(s).

For all cases only one boundary frequency applies (f_{ipb}), based on the following convention:

- if $f \leq f_{ipb}$ do logarithmic interpolation
- if $f > f_{ipb}$ do linear interpolation

Table 32 summarizes a set of pre-defined combinations of boundary frequencies, derived from ITU-T recommendation G993.2 ([i.13], amendment 1).

Table 32: Pre-defined combinations of boundary frequencies, separating logarithmic from linear interpolation of break point tables

bandplan	f_{ipb} upstream	f_{ipb} downstream	Recommended when the following downstream band is included:
998	3 575 kHz 3 575 kHz	138 kHz 276 kHz	DS1.L.A_998 DS1.L.B_998
998ADE	3 575 kHz 3 575 kHz	138 kHz 276 kHz	DS1.L.A_998 DS1.L.B_998
997	2 825 kHz 2 825 kHz 2 825 kHz 2 825 kHz	138 kHz 138 kHz 276 kHz 276 kHz	DS1.A.M1_997 DS1.A.M2_997 DS1.M.M1_997 DS1.M.M2_997
HPE	<TBD> <TBD>	<TBD> <TBD>	<TBD> <TBD>

4.18.3 Building block #2 for "PSD Shaper"

Building block #2 is typically algorithmic in nature, roughly following the way it is formulated in ITU-T recommendation G997.1 [i.16]. A difference is that shaping is to be applied in this building block to PSD templates and not to PSD masks. The model in figure 4 provides the generic idea, but details are currently left for further study.

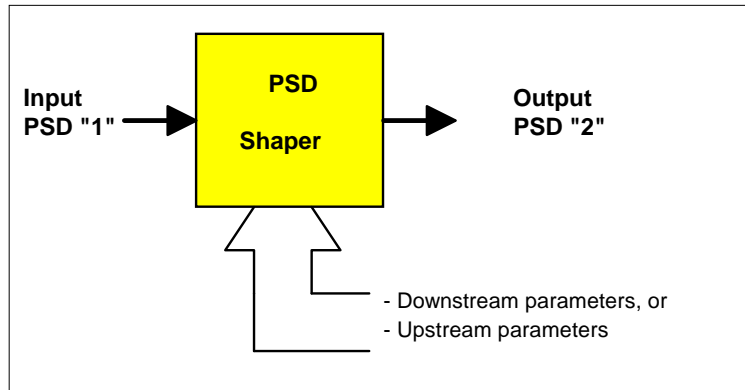

Figure 4: Conceptual description of the "PSD Shaper" block

4.18.4 Building block #3 for "PSD notcher"

Building block #3 enables to punch notches in the spectrum, to reduce the effect of unwanted radiated emissions from VDSL2 causing undue interference to existing licensed users of that part of the spectrum. The description of this building block is roughly the same as for building block #2 ("PSD band constructor"), but its influence on the overall PSD will be different when shaping (in block #3) has been applied. The model in figure 5 starts from an input PSD and combines it subsequently with as many notching PSDs as required.

Combining means within this context: taking the *minimum* of two PSD levels, where one PSD is the selected notching PSD, and the other is a PSD being built-up in previous steps. This minimum is to be evaluated for all frequencies within the band of the selected notching PSD. Outside that band, the PSD will remain unchanged.

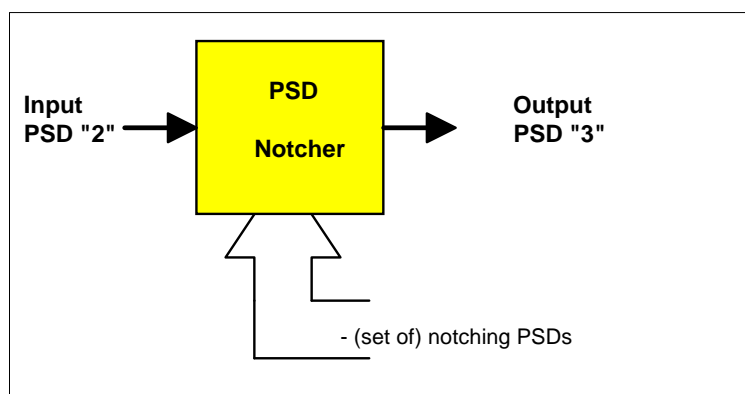

Figure 5: Conceptual description of the "PSD Notcher" block

Table 33 summarizes a set of pre-defined notching PSDs, suitable for reducing egress into internationally standardized amateur radio bands. The model is not restricted to these pre-defined notching PSDs. The numbers are derived from the ETSI VDSL standards [i.11] [i.12]. If required, this notching can be repeated for multiple frequency intervals when more bands are to be notched. In that case the controlling parameter of this model is a set of notching PSDs.

Table 33: Break point tables of several pre-defined notching PSDs

Band to be notched	f [MHz]	P [dBm/Hz]
NB1	1,81	-80
	2,00	-80
NB2	3,50	-80
	3,80	-80
NB3	7,00	-80
	7,20	-80
NB4	10,10	-80
	10,15	-80
NB5	14,00	-80
	14,35	-80
NB6	18,068	-80
	18,168	-80
NB7	21,000	-80
	21,450	-80
NB8	24,890	-80
	24,990	-80
NB9	28,000	-80
	29,100	-80

4.18.5 Building block #4 for "PSD Power Restrictor"

Building block #4, shown in figure 6, enables to cut-back the overall PSD when its aggregate power appears to be above a certain power limit. Such a cut-back is to be applied when for instance a modem implementation is unable to generate powers beyond that limit, or when the output PSD has to be compliant with maximum values specified by the profiles from ITU-T recommendation G993.2 [i.13].

Different modem implementations may follow different strategies to cope with power limitations, and therefore different restriction methods can be applied to this model. A few restriction methods that can ensure that the aggregate power of a modified PSD does not exceed a certain maximum value are pre-defined below, but other methods are not excluded:

- **Attenuator method.** This power restriction requires an algorithm that causes a (frequency independent) attenuation of the full PSD. When the aggregate power of the PSD exceeds a specified limit, the algorithm is to increase this attenuation until a value that makes the aggregate power of the PSD equal to the specified limit. This method is very simple, and is often inadequate to approximate the power restriction in a real modem implementation.
- **Level clipping method.** This power restriction requires an algorithm that clips all PSD values above a certain (frequency independent) "ceiling PSD value". When the aggregate power of the PSD exceeds a specified limit, the algorithm is to lower this "ceiling" down to a value that makes the aggregate power of the PSD equal to the specified limit. This method is typically iterative in nature but rather straightforward.
- **Lower curtain method.** This power restriction requires an algorithm that replaces all PSD values up to a certain "curtain" frequency by a pre-defined PSD floor. When the aggregate power of the PSD exceeds a specified limit, the algorithm is to raise this "curtain" frequency up to a value that makes the aggregate power of the PSD equal to the specified limit. This method is also typically iterative in nature and rather straightforward as well.
- **Upper curtain method.** This power restriction method is similar to the lower curtain method, with the difference that in this method all PSD values above a certain "curtain" frequency are to be replaced by a pre-defined PSD floor.

Other methods may be applied too, but have not been described here.

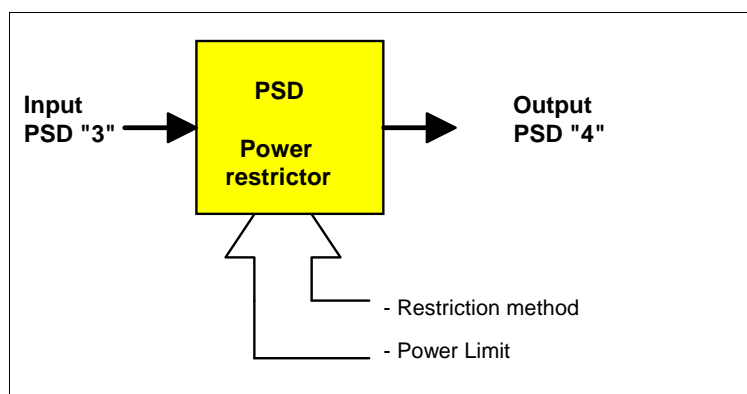

Figure 6: Input/Output Baseline PSD Power Restrictor

4.18.6 Pre-defined downstream tables for "PSD Band Constructor"

The PSD band constructor in building block #1 can be controlled via an arbitrary number of PSD bands. Pre-defined PSD bands for downstream transmission are summarized in tables 35 to 43 and specified by means of breakpoints. Each PSD band has its own (unique) identifier (summarized in table 34), for convenient referencing. A full VDSL2 transmit signal can be built-up from a proper selection of these PSD bands. Examples of meaningful combinations can be found in table 54.

The values are constructed from the breakpoints of ITU-T recommendation G993.2 masks [i.13], roughly by correcting 3,5 dB difference between mask and template for in-band frequencies, and roughly by correcting the PSD according to the constraints in 1 MHz resolution bands for out-of-band frequencies. In addition, some of the pre-defined values are adjusted via a pragmatic compromise between simplicity and ITU details.

The values associated with in-band frequencies are highlighted, to facilitate a convenient interpretation of these tables.

Table 34: Summary of pre-defined PSD bands, for downstream

downstream identifiers for PSD bands	Table Nr.	Remarks on the naming convention
Bandplan 998		
DS1L.A_998 DS1L.B_998	35	L = (Lower part, <2.2M), A = (over POTS, like in annex A of [i.10]) L = (Lower part, <2.2M), B = (over ISDN, like in annex B of [i.10])
DS1U.M1_998 DS1U.M2_998	36	U = (Upper part, >2.2M), M1=(name for regular mask) U = (Upper part, >2.2M), M2=(name for boosted mask)
DS2.M1_998 DS2.M2_998	38	M1 = (name for regular Mask) M2 = (name for boosted Mask)
DS3_998.E17 DS3_998.ADE17 DS3_998.E30 DS3_998.ADE30	40	E17 = (Extended up to 17 MHz) E17 = (Extended up to 17 MHz), ADE = Asymmetric Downstream Extension E30 = (Extended up to 30 MHz) E30 = (Extended up to 30 MHz), ADE = Asymmetric Downstream Extension
DS4_998.E30	42	E30 = (Extended up to 30 MHz)
Bandplan 997		
DS1.A.M1_997 DS1.A.M2_997 DS1.M.M1_997 DS1.M.M2_997	37	A = (over POTS, like in annex A of [i.10]) M1 = (name for regular Mask) A = (over POTS, like in annex A of [i.10]) M2 = (name for boosted Mask) M = (extended upstream, like in annex M of [i.10]) M1 = (name for regular Mask) M = (extended upstream, like in annex M of [i.10]) M2 = (name for boosted Mask)
DS2.M1_997 DS2.M2_997 DS2_997.HPE	39	M1 = (name for regular Mask) M2 = (name for boosted Mask) HPE = (High Pass Extension)
DS3_997.E DS3_997.HPE17 DS3_997.HPE30	41	E = (Extended, applicable to both 17 MHz and 30 MHz variants) HPE17 = (High Pass Extended, up to 17 MHz) HPE30 = (High Pass Extended, up to 30 MHz)
DS4_997.E30 DS4_997.HPE30	43	E30 = (Extended up to 30 MHz) HPE30 = (High Pass Extended, up to 30 MHz)

Table 35: Pre-defined PSD bands for DS1L (lower part of DS1), bandplan 998

	DS1L.A_998	DS1L.B_998
f [Hz]	PSD [dBm/Hz]	PSD [dBm/Hz]
0	-100	-100
3 999	-100	-100
4 000	-96	-96
80 000	-76	Interp
101 200	Interp	-96
137 999	-47,7	Interp
138 000	-40	Interp
227 110	Interp	-65,5
275 999	Interp	-52
276 000	Interp	-40
1 104 000	-40	-40
1 622 000	-50	-50
2 208 000	-51,5	-51,5

Table 36: Pre-defined PSD bands for DS1U (upper part of DS1), bandplan 998

	DS1U.M1_998	DS1U.M2_998
f [Hz]	PSD [dBm/Hz]	PSD [dBm/Hz]
2 208 001	-51,5	-51,5
2 249 000	-53	Interp
2 500 000	-60	Interp
3 749 999	-60	-54,7
3 750 000	-83,5	-83,5
3 894 760	-100	-100
3 999 999	-100	-100
4 000 000	-110	-110

Table 37: Pre-defined PSD bands for DS1, bandplan 997

<i>f</i> [Hz]	DS1.A.M1_997 <i>PSD</i> [dBm/Hz]	DS1.A.M2_997 <i>PSD</i> [dBm/Hz]	DS1.M.M1_997 <i>PSD</i> [dBm/Hz]	DS1.M.M2_997 <i>PSD</i> [dBm/Hz]
0	-100	-100	-100	-100
3 999	-100	-100	-100	-100
4 000	-96	-96	-96	-96
80 000	-76	-76	Interp	Interp
101 200	Interp	Interp	-96	-96
137 999	Interp	-47,7	Interp	Interp
138 000	-53	-40	Interp	Interp
227 110	Interp	Interp	-65,5	-65,5
275 999	Interp	Interp	-52	-52
276 000	Interp	Interp	-40	-40
1 104 000	Interp	-40	-40	-40
1 622 000	-53	-50	-50	-50
2 208 000	Interp	Interp	-51,5	Interp
2 236 000	Interp	Interp	Interp	Interp
2 249 000	-53	Interp	-53	Interp
2 423 000	-60	Interp	Interp	Interp
2 500 000	Interp	Interp	-60	Interp
2 999 999	-60	-53,1	-60	-53,1
3 000 000	-83,5	-83	-83,5	-83
3 175 000	-100	-100	-100	-100

Table 38: Pre-defined PSD bands for DS2, bandplan 998

<i>f</i> [Hz]	DS2.M1_998 <i>PSD</i> [dBm/Hz]	DS2.M2_998 <i>PSD</i> [dBm/Hz]
5 055 624	-110	-110
5 055 625	-100	-100
5 199 999	-83,5	-83,5
5 200 000	-60	-56,2
8 499 999	-60	-58,3
8 500 000	-83,5	-83,5
8 644 566	-100	-100
8 644 567	-112	-112

Table 39: Pre-defined PSD bands for DS2, bandplan 997

<i>f</i> [Hz]	DS2.A_997 <i>PSD</i> [dBm/Hz]	DS2.M_997 <i>PSD</i> [dBm/Hz]	DS2_997.HPE <i>PSD</i> [dBm/Hz]
4 925 000	-110	-110	
5 099 999	-83,5	-83,5	
5 100 000	-60	-56,1	
6 875 000	Interp	Interp	-110
7 049 999	-60	-57,5	-83,5
7 050 000	-83,5	-83,5	-60
7 225 000	-112	-112	Interp
10 125 000			-60
10 125 001			-83,5
10 300 000			-112

Table 40: Pre-defined PSD bands for DS3, bandplan 998

	DS3_998.E17	DS3_998.ADE17	DS3_998.E30	DS3_998.ADE30
<i>f</i> [Hz]	<i>PSD</i> [dBm/Hz]	<i>PSD</i> [dBm/Hz]	<i>PSD</i> [dBm/Hz]	<i>PSD</i> [dBm/Hz]
11 855 638		-112		-112
11 855 639		-100		-100
11 999 999		-83,5		-83,5
12 000 000		-60		-60
13 855 658	-112	Interp	-112	Interp
13 855 659	-100	Interp	-100	Interp
13 999 999	-83,5	Interp	-83,5	Interp
14 000 000	-60	Interp	-60	Interp
17 664 000	-60	-60	Interp	Interp
21 000 000	-83,5	-83,5	Interp	Interp
21 372 373	-100	-100	Interp	Interp
21 372 374	-112	-112	Interp	Interp
21 449 999			-60	Interp
21 450 000			-83,5	Interp
21 594 776			-100	Interp
21 594 777			-112	Interp
24 889 999				-60
24 890 000				-83,5
25 034 810				-100
25 034 811				-112

Table 41: Pre-defined PSD bands for DS3, bandplan 997

	DS3_997.E	DS3_997.HPE17	DS3_997.HPE30
<i>f</i> [Hz]	<i>PSD</i> [dBm/Hz]	<i>PSD</i> [dBm/Hz]	<i>PSD</i> [dBm/Hz]
11 825 000	-112		
11 999 999	-83,5		
12 000 000	-60		
13 825 000	Interp	-112	-112
13 999 999	-60	-83,5	-83,5
14 000 000	-83,5	-60	-60
14 175 000	-112	Interp	Interp
17 664 000		-60	Interp
21 000 000		-83,5	Interp
21 450 000		-112	-60
21 450 001			-83,5
21 625 000			-112

Table 42: Pre-defined PSD bands for DS4, bandplan 998

	DS4_998.E30
<i>f</i> [Hz]	<i>PSD</i> [dBm/Hz]
24 745 527	-112
24 745 528	-100
24 889 999	-83,5
24 890 000	-60
29 999 999	-60
30 000 000	-83,5
30 096 499	-100
30 096 500	-112

Table 43: Pre-defined PSD bands for DS4, bandplan 997

f [Hz]	DS4_997.E30 PSD [dBm/Hz]	DS4_997.HPE30 PSD [dBm/Hz]
19 325 000	-112	
19 499 999	-83,5	
19 500 000	-60	
24 715 000	Interp	-112
24 889 999	Interp	-83,5
24 890 000	Interp	-60
26 999 999	-60	Interp
27 000 000	-83,5	Interp
27 175 000	-112	Interp
29 999 999		-60
30 000 000		-83,5
30 175 000		-112

4.18.7 Pre-defined upstream tables for "PSD Band Constructor"

The PSD band constructor in building block #1 can be controlled via an arbitrary number of PSD bands. Pre-defined PSD bands for upstream transmission are summarized in tables 45 to 53 and specified by means of breakpoints. Each PSD bands has its own (unique) identifier (summarized in table 44), for convenient referencing. A full VDSL2 transmit signal can be built-up from a proper selection of these PSD bands. Examples of meaningful combinations can be found in table 54.

The values are constructed from the breakpoints of ITU-T recommendation G993.2 masks [i.13], roughly by correcting 3,5dB difference between mask and template for in-band frequencies, and roughly by corrected the PSD according to the constraints in 1 MHz resolution bands for out-of-band frequencies. In addition, some of the pre-defined values are adjusted via a pragmatic compromise between simplicity and ITU details.

The values associated with in-band frequencies are highlighted, to facilitate a convenient interpretation of these tables.

Table 44: Overview of pre-defined PSD bands for upstream

upstream identifiers for PSD bands	Table	Remarks on the naming convention
Bandplan 998		
US0.A_998 US0.B_998 US0.M_998	45	A = (like in annex A of [i.10], for over POTS) B = (like in annex B of [i.10], for over ISDN) M = (like in annex M of [i.10])
US1.M1_998 US1.M2_998	47	M1=(name for regular mask) M2=(name for boosted mask)
US2.M1_998 US2.M2_998	49	M1=(name for regular mask) M2=(name for boosted mask)
US3_998 US3_998.ADE	51	ADE = (A)symmetric D(ownstream) E(xtension)
US4_998	51	
Bandplan 997		
US0.A_997 US0.M_997	46	A = (like in annex A of [i.10], for over POTS) M = (like in annex M of [i.10])
US1.M1_997 US1.M2_997	48	M1 = (Name for regular mask) M2 = (Name for boosted mask)
US2.M1_997 US2.M2_997 US2_997.HPE	50	M1 = (Name for regular mask) M2 = (Name for boosted mask) HPE = (High Pass Extension)
US3_997.HPE US3_997.E17 US3_997.E30	52	HPE = (High Pass Extension) E17 = (Extended to 17,664 MHz) E30 = (Extended to 30 MHz)
US4_997.HPE30 US4_997.E30	53	HPE30 = (High Pass Extended to 30 MHz) E30 = (Extended to 30 MHz)

Table 45: Pre-defined PSD bands for US0, bandplan 998

	US0.A_998	US0.B_998	US0.M_998
<i>f</i> [Hz]	<i>PSD</i> [dBm/Hz]	<i>PSD</i> [dBm/Hz]	<i>PSD</i> [dBm/Hz]
0	-100	-100	-100
3 999	-100	-100	-100
4 000	-96	-96	-96
25 875	-38	-96	-41
50 000	Interp	-93,5	Interp
80 000	Interp	-85,3	Interp
120 000	Interp	-38	Interp
138 000	-38	Interp	Interp
243 000	-96,7	Interp	Interp
276 000	Interp	-38	-41
405 125	-100	Interp	Interp
486 810	Interp	Interp	-100
501 500	Interp	-100	Interp
686 000	-100	-100	-100

Table 46: Pre-defined PSD bands for US0, bandplan 997

	US0.A_997	US0.M_997
<i>f</i> [Hz]	<i>PSD</i> [dBm/Hz]	<i>PSD</i> [dBm/Hz]
0	-100	-100
3 999	-100	-100
4 000	-96	-96
25 875	-38	-41
138 000	-38	Interp
243 000	-96,7	Interp
276 000	Interp	-41
493 410	Interp	-100
686 000	-100	-100

Table 47: Pre-defined PSD bands for US1, bandplan 998

	US1.M1_998	US1.M2_998
<i>f</i> [Hz]	<i>PSD</i> [dBm/Hz]	<i>PSD</i> [dBm/Hz]
3 575 001	-100	-100
3 605 175	-100	-100
3 749 999	-83,5	-83,5
3 750 000	-60	-54,7
5 199 999	-60	-56,2
5 200 000	-83,5	-83,5
5 344 693	-100	-100
5 344 694	-112	-112

Table 48: Pre-defined PSD bands for US1, bandplan 997

	US1.M1_997	US1.M2_997
<i>f</i> [Hz]	<i>PSD</i> [dBm/Hz]	<i>PSD</i> [dBm/Hz]
2 825 000	-100	-100
2 999 999	-83,5	-83,5
3 000 000	-60	-53,8
5 099 999	-60	-56,1
5 100 000	-83,5	-83,5
5 275 000	-112	-112

Table 49: Pre-defined PSD bands up to 12 MHz (US2), bandplan 998

	US2.M1_998	US2.M2_998
<i>f</i> [Hz]	PSD [dBm/Hz]	PSD [dBm/Hz]
8 355 624	-112	-112
8 355 625	-100	-100
8 499 999	-83,5	-83,5
8 500 000	-60	-58,3
10 000 000	Interp	-59
12 000 000	-60	-59
12 000 001	-83,5	-83,5
12 144 761	-100	-100
12 144 762	-112	-112

Table 50: Pre-defined PSD bands up to 12 MHz (US2), bandplan 997

	US2.M1_997	US2.M2_997	US2_997.HPE
<i>f</i> [Hz]	PSD [dBm/Hz]	PSD [dBm/Hz]	PSD [dBm/Hz]
6 875 000	-112	-112	
7 049 999	-83,5	-83,5	
7 050 000	-60	-57,5	
9 950 000	Interp	Interp	-112
10 124 999	Interp	-59	-83,5
10 125 000	Interp	Interp	-60
11 999 999	-60	-59	-60
12 000 000	-83,5	-83,5	-83,5
12 175 000	-112	-112	-112

Table 51: Pre-defined PSD bands above 12 MHz (US3+US4), bandplan 998

	US3_998	US4_998	US3_998.ADE
<i>f</i> [Hz]	PSD [dBm/Hz]	PSD [dBm/Hz]	PSD [dBm/Hz]
10 350 000	-112		
10 350 001	-100		
11 999 999	-83,5		
12 000 000	-60		
14 000 000	-60		
14 000 001	-83,5		
14 144 781	-100		
14 144 782	-112		
21 305 249		-112	
21 305 250		-110	
21 449 999		-83,5	
21 450 000		-60	
24 745 847		Interp	-112
24 745 848		Interp	-100
24 889 999		-60	-83,5
24 890 000		-83,5	-60
25 034 810		-100	Interp
25 034 811		-112	Interp
29 999 999			-60
30 000 000			-83,5
30 096 499			-100
30 096 500			-112

Table 52: Pre-defined PSD bands above 12 MHz, US3, bandplan 997

	US3_997.HPE	US3_997.E17	US3_997.E30
<i>f</i> [Hz]	<i>PSD</i> [dBm/Hz]	<i>PSD</i> [dBm/Hz]	<i>PSD</i> [dBm/Hz]
11 825 000	-112		
11 999 999	-83,5		
12 000 000	-60		
13 825 000	Interp	-112	-112
13 999 999	-60	-83,5	-83,5
14 000 000	-83,5	-60	-60
14 175 000	-112	Interp	Interp
17 664 000		-60	Interp
19 499 999		-83,5	-60
19 500 000		Interp	-83,5
19 675 000		-112	-112

Table 53: Pre-defined PSD bands above 12 MHz, US4, bandplan 997

	US4_997.HPE30	US4_997.E30
<i>f</i> [Hz]	<i>PSD</i> [dBm/Hz]	<i>PSD</i> [dBm/Hz]
21 275 000	-112	
21 449 999	-83,5	
21 450 000	-60	
24 889 999	-60	
24 890 000	-83,5	
25 065 000	-112	
26 825 000		-112
26 999 999		-83,5
27 000 000		-60
29 999 999		-60
30 000 000		-83,5
30 175 000		-112

4.18.8 Example definitions of VDSL2 transmitters

The above pre-defined break point tables enable the construction of all PSD combinations (profiles and band plans) being identified in ITU-T recommendation G993.2 [i.13]. For example, table 54 shows a full elaboration for several ITU profiles within limiting mask "B8-4" (also known as "998-M2x-A") and "B8-6" (also known as "998-M2x-B"). In these examples, shaping and notching is disabled. The profiles differ in their combination of allocated bands (within the limiting mask) and maximum power. When a VDSL2 transmitter is specified in this way, its output signal is fully defined.

Table 55 shows for what break-point tables can be considered when constructing PSDs within various masks being defined in ITU-T recommendation G993.2 [i.13]. A full elaboration for all possible combinations has been omitted here for sake of brevity.

Table 54: Full elaboration of the VDSL2 transmit PSD for a few profiles

ITU profile + limiting mask	PSD Band constructor		PSD Shaper	PSD Notcher	PSD Power restrictor
	NF_998 f_{ipb}	DS1L.A_998 DS1U.M2_998 DS2.M2_998			
8b, B8-4 (8b, 998-M2x-A)	NF_998 $f_{ipb} = 138$ kHz	DS1L.A_998 DS1U.M2_998 DS2.M2_998	<none>	<none>	20,5 dBm Level-clipping
	NF_998 $f_{ipb} = 3\,575$ kHz	US0.A_998 US1.M2_998	<none>	<none>	14,5 dBm Level-clipping
8d, B8-4 (8d, 998-M2x-A)	NF_998 $f_{ipb} = 138$ kHz	DS1L.A_998 DS1U.M2_998 DS2.M2_998	<none>	<none>	14,5 dBm Level-clipping
	NF_998 $f_{ipb} = 3\,575$ kHz	US0.A_998 US1.M2_998	<none>	<none>	14,5 dBm Level-clipping
12a, B8-6 (12a, 998-M2x-B)	NF_998 $f_{ipb} = 276$ kHz	DS1L.B_998 DS1U.M2_998 DS2.M2_998	<none>	<none>	14,5 dBm Level-clipping
	NF_998 $f_{ipb} = 3\,575$ kHz	US0.B_998 US1.M2_998 US2.M2_998	<none>	<none>	14,5 dBm Level-clipping

Table 55: Summary of the set of break-point tables that may play a role within various limiting mask being defined in ITU-T recommendation G993.2 [i.13]

Mask name	DS1	DS1	DS1	DS1	DS2	DS2	DS3	DS3	DS3	DS3	DS4		US0	US0	US0	US1	US1	US2	US2	US3	US4	US3
B8-1	x		x		x								x			x		x				
B8-2		x	x		x									x		x		x				
B8-3	x		x		x											x		x				
B8-4	x			x		x							x				x		x			
B8-5		x		x		x									x		x		x			
B8-6		x		x		x								x			x		x			
B8-7	x			x		x											x		x			
B8-8	x			x		x	x										x		x	x		
B8-9		x		x		x	x										x		x	x		
B8-10		x		x		x		x									x		x			
B8-11	x			x		x		x					x				x		x			
B8-12		x		x		x		x						x			x		x			
B8-13	x			x		x			x		x						x		x	x	x	
B8-14		x		x		x			x		x						x		x	x	x	
B8-15		x		x		x				x							x		x			x
B8-16	x			x		x				x							x		x			x

5 Generic receiver performance models for xDSL

A receiver performance model is capable of estimating up to what performance a data stream can be recovered from a noisy signal. In all cases it assumes that this recovery meets predefined quality criteria such as a maximum error better than $BER < 10^{-7}$ (Bit Error Ratio).

The word *performance* refers within this context to a variety of quantities, including noise margin, signal margin and maximum data rate. When the receiver is ideal (zero internal receiver noise, infinite echo cancellation, etc), the noise margin and signal margin become equal.

Performance models are implementation and line code specific. Performance modelling becomes more convenient when broken down into a combination of smaller sub models (see figure 7).

- A line code independent *input* (sub)model that evaluates the effective SNR from received signal, received noise, and various receiver imperfections. Details are described in clause 5.1.

- A line code dependent *detection* (sub)model that evaluates the performance (e.g. the noise margin at a specified bitrate) from the effective SNR. Details are described in clause 5.2.
- An (optional) *echo-coupling* (sub)model that evaluates what portion of the transmitted signal flows into the receiver. Details are described in clause 5.3.

The flow diagram in figure 7 represents an xDSL transceiver that is connected via a common wire pair to another transceiver (not shown). This wire pair transports the transmitted signal, received signal and received noise simultaneously.

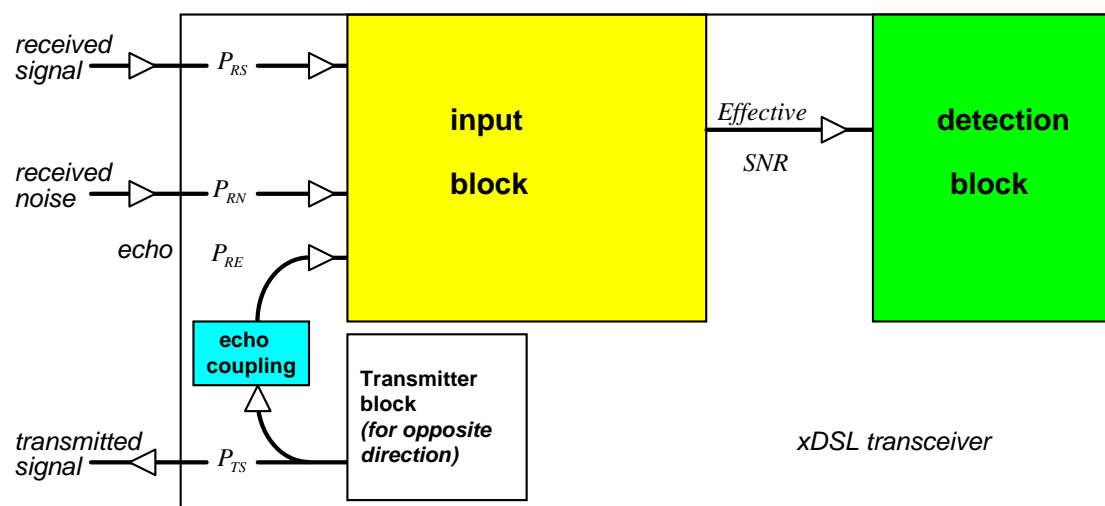

Figure 7: Flow diagram of a transceiver model, build up from individual sub models

The **input block** of the flow diagram in figure 7 requires values for *signal*, *noise* and *echo*. The flow diagram illustrates this for an xDSL transceiver that is connected via a common wire pair to another transceiver (not shown), which transports the following three flows simultaneously:

- The received *signal* power P_{RS} carries the data that is to be recovered. This signal originates from the transmitter at the other side of the wire pair, and its level is attenuated by cable loss.
- The received *noise* power P_{RN} is all that is received when the transmitters at both sides of the link under study are silent. The origin of this noise is mainly crosstalk from internal disturbers connected to the same cable (crosstalk noise), and partly from external disturbers (ingress noise).
- The received *echo* power P_{RE} is all that is received when the transmitter at the other end of the wire pair is silent, as well as all internal and external disturbers. It is a residue that will be received when a transmitter and a receiver are combined into a transceiver, and co-connected via a hybrid to the same wire pairs. No hybrid is perfect, so a portion (P_{RE}) of the transmitted signal (P_{TS}) will leak into the receiver and is identified as echo. Usually most of this is due to mismatch between the termination impedance, presented by the transceiver and the near end of the wire pair. Gauge changes along the wire pair also contribute echo.
- When the hybrid of that transceiver is unbalanced due to mismatched termination impedances (of the cable), then a portion (P_{RE}) of the transmitted signal (P_{TS}) will leak into the receiver and is identified as echo.

The input block in figure 7 evaluate a quantity called *effective SNR* (Signal to noise Ratio) that indicates to what degree the received signal is deteriorated by noise, residual echo and all kinds of implementation imperfections. Due to signal processing in the receiver, the *input SNR* (the ratio between signal power, and the power-sum of noise and echo) will change into the *effective SNR* at some virtual internal point at the receiver. The effective SNR can be better or worse than the input SNR. Receivers with build-in echo cancellation can take advantage of a-priori knowledge on the echo, and can suppress most of this echo to improve the effective SNR. On the other hand, all analogue receiver electronics produce shot noise and thermal noise, the A/D-converter produces quantization noise, and the equalization has its limitations as well. The combination of all these individual imperfections deteriorates the effective SNR.

In principle all parameters of the effective SNR can be assumed as frequency dependent, but this dependency has been omitted here for reasons of simplicity. In addition, external change of signal and noise levels will modify the value of this effective SNR.

The **detection block** of the flow diagram in figure 7 requires this effective SNR to evaluate from that the performance as *margin* (such as noise margin, or signal margin). For many detection models, this margin is not provided by a closed expression, but by an equation from which this margin is to be solved. A simulation program may follow an iterative approach to solve this: controlling this margin in the input block so that the effective SNR changes and the equation in the detection block can be met.

In principle, the detection block is dedicated to line-code specific imperfections only, but may also include receiver imperfections that are not covered by the input block.

The **echo-coupling block** is optional, in case the input block does not deal with the related imperfections. Simple (first order) models for the input block cannot distinguish between receiver imperfection originated from echo and from other causes. When these simplified models are used, the echo-coupling block will not be required in the receiver performance model.

Clause 5 details (sub)models for the afore mentioned blocks in a receiver performance model, but is restricted to *generic* performance models only. Clause 6 is dedicated to implementation *specific* models by additionally assigning values to all parameters of a generic model.

5.1 Generic input models for effective SNR

An input (sub) model describes how to evaluate the effective SNR, as intermediate result (see figure 7), from various input quantities and imperfections. To simplify further analysis of performance quantities like *noise margin* and *signal margin*, the effective SNR is often expressed in its *offset format*, characterized by an additional parameter m . The associated expression is defined for each model individually.

By using this parameter m the external noise level can be increased (for noise margin calculations) or the external signal level can be decreased (for signal margin calculations). The convention is that when $m=1$ (equals zero dB) the effective *offset SNR* equals the effective SNR itself. When the value of parameter m increases, the effective offset SNR decreases.

5.1.1 First order input model

This input model is a simplified model that assumes that the SNR of the input signal is internally modified by internal receiver noise (P_{RNO}). Most imperfections of the receiver (such as front-end noise, imperfect echo suppression, imperfect equalization and quantization noise) are assumed to be concentrated in a single virtual internal noise source (P_{RNO}). Figure 8 shows the flow diagram of an xDSL transceiver model showing the elements of a first order input model for effective SNR evaluation, and how to incorporate it in the receiver performance model.

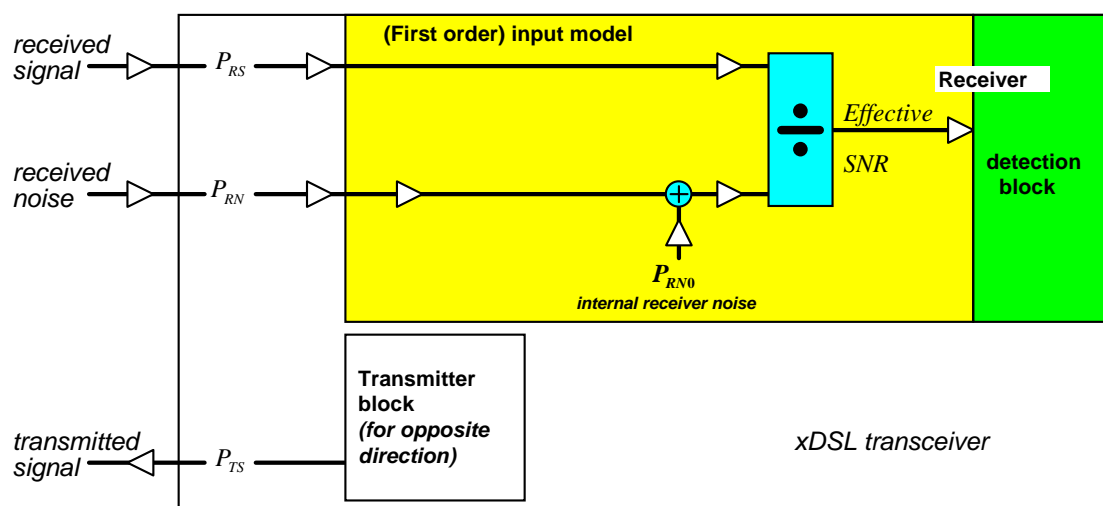

Figure 8: Flow diagram of a transceiver model that incorporates a linear first order input model for the determination of the effective SNR

Expression 8 summarizes how to evaluate the effective SNR for this model, in plain and in offset format. Table 56 summarizes the associated parameters.

Plain format:	$SNR(f)$
Noise offset format:	$SNR_{ofs,N}(m, f)$
Signal offset format:	$SNR_{ofs,S}(m, f)$

Expression 8: Effective SNR, in various formats, when using the first order input model

Table 56: Associated parameters and quantities for a first order input model - All PSD levels may be frequency dependent. Constant $P_0=1\text{mW}$

Input quantities	linear	in dBm or dB	remarks
Received signal power	P_{RS}	$10 \times \log_{10}(P_{RS}/P_0)$	External signal
Received noise power (crosstalk)	P_{RN}	$10 \times \log_{10}(P_{RN}/P_0)$	External noise
Model Parameters			
Internal receiver noise power	P_{RN0}	$10 \times \log_{10}(P_{RN0}/P_0)$	Internal noise
Output quantities			
Signal to noise ratio (effective)	SNR	$10 \times \log_{10}(SNR)$	Frequency dependent

5.2 Generic detection models

This clause identifies several generic (sub) models for the detection block: one line code independent model derived from the Shannon capacity limit, and various line code dependent models dedicated to PAM, CAP/QAM or DMT line coding. Table 57 summarizes the naming convention for input and output quantities.

Table 57: Symbols used for input and output quantities of detection models

Input quantities	linear	in dB or dBm	remarks
Signal to Noise Ratio	SNR	$10 \times \log_{10}(SNR)$	Ratio of powers (frequency dependent)
Output quantities			
Noise margin	m_n	$10 \times \log_{10}(m_n)$	Ratio of noise powers
Signal margin	m_s	$10 \times \log_{10}(m_s)$	Ratio of signal powers

On input, the detection block requires an effective SNR, as provided by the input block. This SNR is a function of the frequency f . When the offset format is used for describing the SNR, it will also be a function of the offset parameter m . This offset format is specified individually for each model in clause 5.1.

On output, the detection block evaluates a signal margin m_n (or a noise margin m_s when more appropriate). This margin parameter is an important measure for the transport quality that is achieved under noisy conditions.

- The *Noise Margin* m_n indicates how much the received noise power can increase before the transmission becomes unreliable.
- The *Signal Margin* m_s indicates how much the received signal power can decrease before the transmission becomes unreliable.

Unless explicitly specified otherwise, the word *margin* refers in the present document to *noise margin*.

NOTE: From an xDSL deployment point of view, the analysis of noise margin is preferred over signal margin, since the (crosstalk) noise is the quantity that may increase when more systems are connected to the same cable. Many xDSL implementations, however, do report margin numbers that are not exactly equal to this noise margin, since the detection circuitry cannot make a distinction between external noise (due to crosstalk) and internal noise (due to imperfect electronics). These margins are often an estimate closer in value to the signal margin than to the noise margin.

5.2.1 Generic Shifted Shannon detection model

The calculation of the margin m using the generic Shifted Shannon detection model, is equivalent to solving the equation in expression 9. It has been derived from Shannon's capacity theorem, by reducing the effective SNR ("shifting" on a dB scale) by the SNR-gap Γ , to account for the imperfections of practical detectors. The associated parameters are summarized in table 58.

The effective SNR is to be evaluated by using one of the input models described in clause 5.1. Depending on what offset format is used for the SNR expression (see clause 5.1), the calculated margin m will represent the noise margin m_n or the signal margin m_s .

$$f_b = \int_{f_c - B/2}^{f_c + B/2} \log_2 \left(1 + \frac{SNR_{ofs}(m, f)}{\Gamma} \right) \times df$$

Expression 9: Equation of the Shifted Shannon detection model, for solving the margin m

Table 58: Parameters used for Shifted Shannon detection models

Model Parameters	linear	in dB	Remarks
SNR gap	Γ	$10 \times \log_{10}(\Gamma)$	
Line rate	f_b		= data rate (all payload bits that are transported in 1 sec) + overhead bitrate
Centre frequency	f_c		Centre value of the most relevant spectrum
Bandwidth	B		Width of most relevant spectrum
Margin	m	$10 \times \log_{10}(m)$	

The various parameters used within this generic detection model are summarized in table 58. The model can be made specific by assigning values to all these model parameters.

- The SNR-gap (Γ) is a performance parameter that indicates how close the detection approaches the Shannon capacity limit.
- The line rate (f_b) is usually higher than the data rate (0 % to 30 %) to transport overhead bits for error correction, signalling and framing.
- The bandwidth is a parameter that indicates what frequency range of the received spectrum is relevant for data transport. The model assumes that only frequencies within this range can pass the receive filters.

5.2.2 Generic PAM detection model

The calculation of the margin m using the generic PAM detection model is equivalent to solving the equation in expression 10. This model assumes ideal decision feedback equalizer (DFE) margin calculations. The associated parameters are summarized in table 59.

The effective SNR is to be evaluated by using one of the input models described in clause 5.1. Depending on what offset format is used for the SNR expression (see clause 5.1), the calculated margin m will represent the noise margin m_n or the signal margin m_s .

$$SNR_{req} = \Gamma \times (2^{2 \times b} - 1) = \exp \left(\frac{1}{f_s} \times \int_0^{f_s} \ln \left(1 + \sum_{n=N_L}^{N_H} SNR_{ofs}(m, f + n f_s) \right) \times df \right)$$

Expression 10: Equation of the PAM-detection model, for solving the margin m

The SNR gap Γ , being used in the above expression 10, is a combination of various effects. This Γ parameter is often split-up into the following three parts:

- A theoretical modulation gap Γ_{PAM} (in the order of 9,75 dB, at BER=10⁻⁷).
- A theoretical coding gain Γ_{coding} (usually in the order of 3 dB to 5 dB), to indicate how much additional improvement is achieved by the chosen coding mechanism.
- An empirical implementation loss Γ_{impl} (usually a few dB as well), indicating how much overall performance degradation is caused by implementation dependent imperfections (e.g. echo cancellation, analogue front end realization, equalization, etc), without identifying its true cause.

When Γ is split-up into the above three parts, its value can

be evaluated as follows:

$$\text{SNR gap (linear):} \quad \Gamma = \Gamma_{PAM} / \Gamma_{coding} \times \Gamma_{impl}$$

$$\text{SNR gap (in dB):} \quad \Gamma_{dB} = \Gamma_{PAM_dB} - \Gamma_{coding_dB} + \Gamma_{impl_dB}$$

The margin value, which can be either noise margin or signal margin, is not included in the SNR gap as it is contained in the offset SNR expression as described in clause 5.1.

Table 59: Parameters used for PAM detection models

Model Parameters	linear	in dB	remarks
SNR gap (effective)	Γ	$10 \times \log_{10}(\Gamma)$	$= SNR_{req} / (2^{2 \cdot b} - 1)$
SNR gap in parts:	Γ_{PAM}	$10 \times \log_{10}(\Gamma_{PAM})$	Modulation gap for PAM
	Γ_{coding}	$10 \times \log_{10}(\Gamma_{coding})$	Coding gain
	Γ_{impl}	$10 \times \log_{10}(\Gamma_{impl})$	Implementation loss
Required SNR	SNR_{req}	$10 \times \log_{10}(SNR_{req})$	$= \Gamma \times (2^{2 \cdot b} - 1)$
Line rate	f_b		= data rate (all payload bits that are transported in 1 sec) + overhead bitrate
Symbol rate	f_s		$= f_b / b$
Bits per symbol	b		$= f_b / f_s$ (can be non-integer)
Summation range	N_L, N_H		On default: $N_L = -2$ and $N_H = +1$
Margin	m	$10 \times \log_{10}(m)$	

The various parameters in table 59 used within this generic detection model have the following meaning:

- The SNR-gap (Γ) and required SNR (SNR_{req}) are equivalent parameters and can be converted from one to the other. The advantage of using Γ over SNR_{req} is that Γ can be defined with similar meaning for all theoretical models in the frequency domain (Shifted Shannon, CAP, PAM, and DMT). The advantage of using SNR_{req} over Γ is that this quantity is closer related to the SNR observed at the decision point of the detection circuitry.
- The line rate (f_b) is usually higher than the data rate (0 % to 30 %) to transport overhead bits for error correction, signalling and framing. The symbol rate is the line rate divided by the number of bits packed together in a single symbol.
- The summation range for n is from N_L to N_H , and this range has to be defined to make this generic model specific. Commonly used values for PAM, using over sampling, are $N_L = -2$ and $N_H = +1$. This corresponds to T/3-spaced equalization. Wider ranges are not excluded.

5.2.3 Generic CAP/QAM detection model

The calculation of the margin m using the generic CAP/QAM detection model is equivalent to solving the equation in expression 11. This model assumes ideal Decision Feedback Equalizer (DFE) margin calculations. The associated parameters are summarized in table 60.

The effective SNR is to be evaluated by using one of the input models described in clause 5.1. Depending on what offset format is used for the SNR expression (see clause 5.1), the calculated margin m will represent the noise margin m_n or the signal margin m_s .

$$SNR_{req} \equiv \Gamma \times (2^b - 1) = \exp \left(\frac{1}{f_s} \times \int_0^{f_s} \ln \left(1 + \sum_{n=N_L}^{N_H} SNR_{ofs}(m, f + n f_s) \right) \times df \right)$$

Expression 11: Equation of the CAP/QAM-detection model, for solving the margin m

The (effective) SNR gap Γ , being used in the above expression 11, is a combination of various effects. This has been explained in more detail for the PAM detection model. The theoretical modulation gap, identified as Γ_{CAP} for the CAP/QAM detection model, is in the order of 9,8 dB for BER=10⁻⁷.

The margin value, which can be either noise margin or signal margin, is not included in the SNR gap as it is contained in the offset SNR expression as described in clause 5.1.

Table 60: Parameters used for CAP/QAM detection models

Model Parameters	linear	in dB	remarks
SNR gap (effective)	Γ	$10 \times \log_{10}(\Gamma)$	$= SNR_{req} / (2^b - 1)$
SNR gap in parts:	Γ_{CAP}	$10 \times \log_{10}(\Gamma_{PAM})$	Modulation gap for CAP/QAM
	Γ_{coding}	$10 \times \log_{10}(\Gamma_{coding})$	Coding gain
	Γ_{impl}	$10 \times \log_{10}(\Gamma_{impl})$	Implementation loss
Required SNR	SNR_{req}	$10 \times \log_{10}(SNR_{req})$	$= \Gamma \times (2^b - 1)$
Line rate	f_b		= data rate (all payload bits that are transported in 1 sec) + overhead bitrate
Symbol rate	f_s		$= f_b / b$
Bits per symbol	b		$= f_b / f_s$ (can be non-integer)
Summation range	N_L, N_H		On default: $N_L=0$ and $N_H=+3$
Margin	m	$10 \times \log_{10}(m)$	

The various parameters in table 60 used within this generic detection model have the following meaning:

- The SNR-gap (Γ) and required SNR (SNR_{req}) are equivalent parameters and can be converted from one to the other. The advantage of using Γ over SNR_{req} is that Γ can be defined with similar meaning for all theoretical models in the frequency domain (Shannon, CAP, PAM, and DMT). The advantage of using SNR_{req} over Γ is that this quantity is closer related to the SNR observed at the decision point of the detection circuitry.
- The line rate is usually higher than the data rate (0 % to 30 %), to transport overhead bits for error correction, signalling and framing. The symbol rate is the line rate divided by the number of bits packed together in a single symbol.
- The summation range for n is from N_L to N_H . Commonly used values for CAP/QAM systems using over sampling are $N_L=0$ and $N_H=+3$. This holds when the carrier frequency positions the spectrum low in the frequency band (e.g. CAP-based HDSL). Other values may be more appropriated when the carrier frequency moves the spectrum to higher frequencies (e.g. CAP based VDSL).

5.2.4 Generic DMT detection model

The calculation of the margin m using the generic DMT detection model is equivalent to solving the equations in expression 12, for a given line rate f_b (or given *data* line rate f_{bd}). The associated parameters are summarized in table 61, and function *load* is specified by the chosen bit-loading algorithm. The effective SNR is to be evaluated by using one of the input models described in clause 5.1. Depending on what offset format $SNR_{ofs}(m, f)$ is used to express this effective SNR for margins other than $m=1$ (equals zero dB), the solved margin m will result in the noise margin m_n or the signal margin m_s .

$$\begin{array}{l}
 b_k = \log_2 \left(1 + \frac{SNR_{ofs}(m, f_k)}{\Gamma} \right) \quad [bit / tone / symbol] \\
 f_{bd} = f_{sd} \times b = f_{sd} \times \sum_{k \in tones} load(b_k) \quad [bit / s] \\
 f_b = f_{bd} + f_{bs} \quad [bit / s]
 \end{array}$$

NOTE: The words "tone" refers to "sub-carrier" but is preferred here to express dimensions like [bits/tone].

Expression 12: Equations of the DMT-detection model, for solving the margin m for a given *data* line rate f_{bd} , and a given *data* symbol rate f_{sd} - The rate f_{sd} excludes all DMT symbols dedicated to synchronization

Bit-loading algorithm

The DMT sub-carriers are all positioned (centred) at a multiple of the sub-carrier frequency spacing Δf , and each sub-carrier theoretically may carry any fragment of a symbol, while a symbol can carry many bits (typically a few hundred or more). The way this bit space (bits per tone per symbol) is used to load each sub-carrier with bits is implementation dependent.

Bit-loading algorithms commonly use masking. Masking means skipping carriers for loading when their bit space b_k is below some predefined minimum value b_{\min} , and limiting the bit-loading to some pre-defined maximum when the bit space b_k exceeds some predefined maximum b_{\max} . This masking process is summarized in expression 13.

$b_k < b_{\min}$	\Rightarrow	$load(b_k) \equiv 0$
$b_{\min} \leq b_k \leq b_{\max}$	\Rightarrow	$load(b_k) \equiv b_k$
$b_k > b_{\max}$	\Rightarrow	$load(b_k) \equiv b_{\max}$

Expression 13: The bit loading used in (fractional) bit-loading algorithms

When the data transport is operating on its limits (margin $m=1$, or zero dB), the following bit-loading algorithms may apply, in addition to masking:

- *Fractional bit-loading* (FBL): sometimes referred to as *water-filling* - is a pure theoretical approach enabling loading of any real number of bits per symbol in any sub-carrier k (including non-integer fractions). This maximizes the use of the available capacity, but is impractical to implement.
- *Truncated bit-loading* (TBL): is a more feasible algorithm in practice, and loads on each sub-carrier k a number of bits equal to the largest non-negative integer *below* the bit space b_k .
- *Rounded bit-loading* (RBL): is also feasible in practice, and loads each sub-carrier k with a number of bits equal to the nearest non-negative integer of bit space b_k .
- *Gain adjusted bit-loading* (GABL): is a sophisticated combination of rounded bit-loading and adjustment of powers to each of the sub-carriers, so that each individual bit space b_k approaches a rounded value (minimizes the loss of capacity), while the total transmit power is kept unchanged on average.

In various applications, it may be assumed that the capacity of well-designed *gain adjusted* bit-loading algorithms closely match those achieved by *fractional* bit-loading algorithm. For the sake of simplicity, and for making capacity calculations in the present document less implementation dependent, the fractional bit-loading algorithm with constraint number of bits per sub-carrier and symbol, as in expression 13, is used as default for DMT calculations in the present document, unless specified explicitly otherwise.

SNR-Gap

The (effective) SNR gap I , being used in expression 12, is a combination of various effects. This has been explained in more detail for the PAM detection model. The theoretical modulation gap, identified as I_{DMT} for the DMT detection model, is in the order of 9,75 dB for BER=10⁻⁷.

The margin value, which can be either noise margin or signal margin, is not included in the SNR gap as it is contained in the offset SNR expression as described in clause 5.1.

Associated parameters

Table 61: Parameters used for DMT detection models

Input quantities	linear	in dB	remarks
Signal to Noise Ratio (effective value)	SNR	$10 \times \log_{10}(SNR)$	Frequency dependent ratio of powers
Model Parameters	linear	in dB	remarks
SNR gap (effective)	Γ	$10 \times \log_{10}(\Gamma)$	$= SNR_{req} / (2^{2 \cdot b} - 1)$
SNR gap in parts:	Γ_{DMT} Γ_{coding} Γ_{impl}	$10 \times \log_{10}(\Gamma_{DMT})$ $10 \times \log_{10}(\Gamma_{coding})$ $10 \times \log_{10}(\Gamma_{impl})$	Modulation gap for DMT Coding gain Implementation loss
Symbol rate		f_s	Symbol rate, being the total number of <i>all</i> DMT symbols, transmitted in 1 s (Thus <i>data</i> symbols and <i>synch</i> symbols)
		f_{sd}	Symbol rate fragment, being the rate of <i>data</i> symbols only (without the overhead of <i>synch</i> symbols) that carry payloads bits
Line rate		f_b	Line rate, being the total number of <i>all</i> bits (for <i>data</i> , <i>synch</i> and other overhead) that is to be transported in 1 s
		f_{bd}	Line rate fragment, caused by the bits in <i>data</i> symbols only
		f_{bs}	Line rate fragment, caused by the bits in <i>synch</i> symbols only
Available set of sub-carriers		$\{k\}$	Can be a subset of all possible sub-carriers. (e.g. $k \in [7:255]$)
Centre frequency location of tone k ; $k \in \text{tones}$		f_k	$f_k = k \times \Delta f$ $\Delta f = 4,3125 \text{ kHz}$ in all current DMT systems
Bits per data symbol		$b = \sum b_k$	$b = f_{bd} / f_{sd}$ The bits of each data symbol are spread out over all used sub-carriers, in fragments of b_k
Bit-loading algorithm		FBL TBL RBL GABL	Can be one of: <ul style="list-style-type: none"> Fractional bit-loading (a.k.a. water filling) Truncated bit-loading Rounded bit-loading Gain adjusted bit-loading
Minimum bit loading		b_{min}	Minimum number of bits per sub-carrier and per data symbol
Maximum bit loading		b_{max}	Maximum number of bits per sub-carrier and per data symbol
Output quantities	linear	in dB	remarks
Noise margin	m_n	$10 \times \log_{10}(m_n)$	
Signal margin	m_s	$10 \times \log_{10}(m_s)$	

The various parameters in table 61, used within this generic detection model, have the following meaning:

- The SNR-gap (Γ) is a parameter that shows how far from the Shannon capacity limit a modem is performing at a certain bit error rate.
- The symbol rate f_s , in [baud] or [symbols/s], refers to *all* symbols being transmitted in one second. Most of these are so called *data* symbols, because they carry bits for data transport, but after sending many data symbols, an additional *synch* symbol may be transmitted to keep the DMT transmission synchronized. The bits in each symbol are spread out over all involved DMT sub-carriers. The symbol rate is the sum of two fragments:
 - The *data* symbol rate f_{sd} , referring only to the rate of *data* symbols.
 - The *synch* symbol rate f_{ss} , referring only to the rate of remaining *synch* symbols.

In ADSL, for example, one additional *synch* symbol is transmitted after sending 68 *data* symbols, and 4 000 *data* symbols are transmitted in one second.

In VDSL, for example, the *data* symbol rate and (total) symbol rate are equal as there is no extra synchronization symbol as in ADSL.

- The line rate f_b [bits/s] refers to *all* bits being transmitted over the line in one second, including *all* overhead bits. Examples of overhead bits are bits for synchronization, all types of coding, the embedded operation channel, etc.

Similar to the symbol rate, the line rate is the sum of two fragments:

- The *data* line rate f_{bd} , refers to all bits in *data* symbols only, and covers payload bits as well as all overhead bits in a *data* symbol.
- The *synch* line rate f_{bs} , refers to all bits in the remaining *synch* symbols, and can be considered as 100 % overhead for transporting payload bits.

The bits in each symbol are spread out over the involved sub-carriers.

- The data rate f_d , in [bits/s], refers to the rate of *payload* bits only (also known as net data bits) that are to be transported by the DMT system. This rate does not include any transmission overhead, and is therefore lower than the line rate. Performance requirements are usually specified for these rates only, as for example the ETSI standard for ADSL (TS 101 388 [i.7]).
- The available sub-carriers are specified by a list of integers, indicating what centre frequencies are allocated to individual sub-carriers. For instance in ADSL it can contain any of the sub-carriers from tone 7 to tone 255.
- The centre frequency of a sub-carrier k is $k \times \Delta f$, where Δf is the sub-carrier spacing.
- b_{\min} and b_{\max} are the minimum and maximum number of bits, respectively, used in the masking process of the bit loading.

5.3 Generic models for echo coupling

5.3.1 Linear echo coupling model

This model describes a property of linear hybrids in transceivers, and models what portion of the transmitted signal couples directly into the receiver. The hybrid is characterized by two parameters:

- R_V , representing the output impedance of the transceiver. Commonly used values are the design impedances of the modems under test, including 100 Ω for ADSL and 135 Ω for SDSL.
- Z_B , representing the termination impedance that causes the hybrid to be perfectly balanced. This means that when the hybrid is terminated with this "balance impedance", no echo will flow into the receiver. For well-designed hybrids, this balance impedance is a "best guess" approximation of the "average" impedance of cables being used.

Figure 9 shows an equivalent circuit diagram of the above hybrid, represented as a Wheatstone bridge. The associated transfer function $H_E(j\omega)$ expresses what portion of the transmit signal will appear as echo.

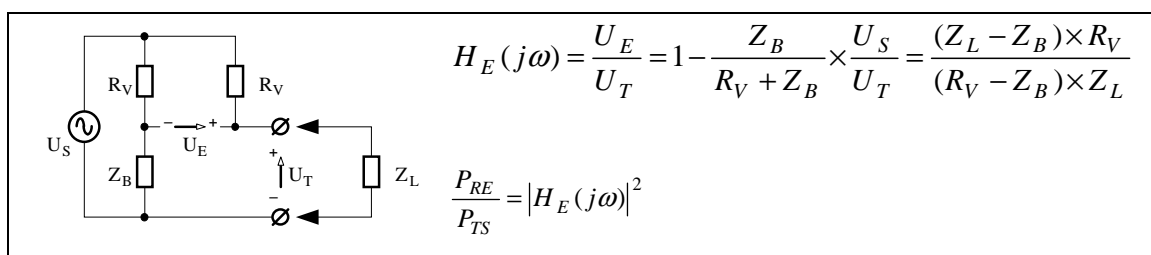

NOTE: The identifiers P_{RE} and P_{TS} refer to power flow values used in figure 7.

Figure 9: Flow diagram of the basic model for echo coupling

When using this basic model for echo coupling in a full simulation, value R_V can be made equal to the design impedance of the modem under test, and value Z_B can be made equal to the complex and frequency dependent input impedance of the cable, terminated at the other cable end with a load impedance equal to R_V . Values for R_V and Z_B are implementation specific.

6 Specific receiver performance models for xDSL

This clause defines parameter values for the generic performance models of clause 5, to provide implementation specific models for various xDSL modems.

6.1 Receiver performance model for "HDSL.2B1Q"

The reach predicted by this calculation model, under the stress conditions (loss, noise) of the associated ETSI HDSL specification (TS 101 135 [i.4]), is close to the reach required by ETSI specification (TS 101 135 [i.4]).

The receiver performance model for ETSI compliant HDSL.2B1Q is built-up from the following building blocks:

- A first order (linear) input model for the input block, specified in clause 5.1.1, that combines all imperfections (front-end noise, residual echo, equalization errors), in one virtual noise source.
- The generic PAM detection model, specified in clause 5.2.2.
- The parameter values specified in table 63.

The parameter values, used in the receiver performance model for ETSI compliant two-pair HDSL.2B1Q/2, are summarized in table 62. Parts of them are directly based on HDSL specifications. The remaining values are based on theory and assumptions.

Table 62: Values for the parameters used in the performance model, obtained from ETSI requirements for HDSL.2B1Q/2 [i.4]

Model Parameter		HDSL.2B1Q/2
SNR-Gap (effective)	Γ_{dB}	12,25 dB
SNR-Gap in parts	$\Gamma_{PAM,dB}$	9,75 dB
	$\Gamma_{coding,dB}$	0 dB
	$\Gamma_{impl,dB}$	2,5 dB
Receiver noise	$P_{RNO,dB}$	-140 dBm/Hz
Data rate	f_d	2 x 1 024 kb/s
Line rate	f_b	1 168 kb/s
bits per symbol	b	2
Summation bounds in the PAM model	N_H	+1
	N_L	-2
Derived Parameter		
Required SNR	SNR_{req}	$\Gamma \times (2^{2b} - 1)$
	$SNR_{req,dB}$	$\approx 24,0$ dB
Symbol rate	f_s	$f_b / b = 584$ kbaud
NOTE:	The receiver noise in this model has an unrealistic low level, but this is irrelevant for SpM studies in a mixed noise environment. As a result, this model will give too optimistic estimates of reachable distance in scenarios without any self crosstalk or any equivalent noise with similar bandwidth.	

6.2 Receiver performance model for "HDSL.CAP"

This calculation model is capable for predicting a performance that is benchmarked against the performance requirements of an ETSI compliant HDSL-CAP modem (TS 101 135 [i.4]). The reach predicted by this model, under the stress conditions (loss, noise) of the associated the TS 101 135 [i.4], is close to the reach required by TS 101 135 [i.4].

The receiver performance model for ETSI compliant HDSL-CAP is build-up from the following building blocks:

- A first order (linear) input model for the input block, specified in clause 5.1.1, that combines all imperfections (front-end noise, residual echo, equalization errors), in one virtual noise source.
- The generic CAP/QAM detection model, specified in clause 5.2.3.
- The parameter values specified in table 63.

The parameter values, used in the receiver performance model for ETSI compliant HDSL-CAP, are summarized in table 63. Parts of them are directly based on HDSL specifications. The remaining values are based on theory, followed by an iterative fit of the model to meet the ETSI reach requirements for HDSL-CAP under the associated stress conditions.

Various parameters are derived directly from the above-mentioned parameters. Their purpose is to simplify the required expression of the CAP/QAM-detection model used.

Table 63: Values for the parameters of the performance model, obtained from ETSI requirements for HDSL-CAP [i.4]

Model Parameter		HDSL.CAP/2	HDSL.CAP/1
SNR-Gap (effective)	Γ_{dB}	6,8 dB	6,8 dB
SNR-Gap in parts	Γ_{CAP_dB}	9,8 dB	9,8 dB
	Γ_{coding_dB}	5,0 dB	5,0 dB
	Γ_{impl_dB}	2,0 dB	2,0 dB
Receiver noise	P_{RNO_dB}	-105 dBm/Hz	-105 dBm/Hz
Data rate	f_d	2x1 024 kb/s	1 x 2 048 kb/s
Line rate	f_b	1 168 kb/s	2 330 kb/s
Carrier frequency	f_c	138,30 kHz	226,33 kHz
bits per symbol	b	5	6
Summation bounds in the CAP/QAM model	N_H	+3	+3
	N_L	0	0
Derived Parameter			
Required SNR	SNR_{req}	$\Gamma \times (2^b - 1)$	$\Gamma \times (2^b - 1)$
	SNR_{req_dB}	$\approx 21,7$ dB	$\approx 24,8$ dB
Symbol rate	f_s	$f_b / b = 233,6$ kbaud	$f_b / b = 388,3$ kbaud

6.3 Receiver performance model for "SDSL"

This calculation model is capable of predicting a performance that is benchmarked against the performance requirements of an ETSI compliant SDSL modem (TS 101 524 [i.5]). The reach predicted by this model, under the stress conditions (loss, noise) of the associated the ETSI SDSL specification (TS 101 524 [i.5]) is close to the reach required by that ETSI specification. Deviations of predictions and requirements are less than 4,5 % in reach, and less than 125 m. The validity of the predicted performance holds for a wider range of stress conditions.

NOTE: These models are applicable to SDSL 16-UC-PAM at rates up to 2,312 Mb/s.

The receiver performance model for ETSI compliant SDSL is build-up from the following building blocks:

- A first order (linear) input model for the input block, specified in clause 5.1.1, that combines all imperfections (front-end noise, residual echo, equalization errors), in one virtual noise source (P_{RNO}).

- The generic PAM detection model, specified in clause 5.2.2.
- The parameter values specified in table 64.

The parameter values, used in the receiver performance model for ETSI compliant SDSL, are summarized in table 64. Some of these are directly based on SDSL specifications. The remaining values are based on theory.

Various parameters are derived from the above-mentioned parameters. Their purpose is to simplify the required expression of the PAM-detection model used.

Table 64: Values for the parameters of the performance model, obtained from ETSI requirements for SDSL [i.5]

Model parameter		SDSL model	
		≤ 256 kb/s	> 256 kb/s
SNR-Gap (effective)	Γ_{dB}	6,95 dB	6,25 dB
SNR-Gap in parts	$\Gamma_{\text{PAM_dB}}$	9,75 dB	9,75 dB
	$\Gamma_{\text{coding_dB}}$	4,4 dB	5,1 dB
	$\Gamma_{\text{impl_dB}}$	1,6 dB	1,6 dB
Receiver noise	$P_{\text{RNO_dB}}$	-140 dBm/Hz	
Data rate	f_{d}	192 ... 2 304 kb/s	
Line rate	f_{b}	$f_{\text{d}} + 8$ kb/s	
bits per symbol	b	3	
Summation bounds in PAM model	N_{H}	+1	
	N_{L}	-2	
Derived Parameter			
Required SNR	SNR_{req}	$\Gamma \times (2^{2b} - 1)$	
	$SNR_{\text{req_dB}}$	≈ 24,95 dB	≈ 24,25 dB
Symbol rate	f_{s}	$f_{\text{b}} / 3$	

6.4 Receiver performance model for "ADSL/POTS (FO)"

This calculation model is capable of predicting a performance that is benchmarked against the performance requirements of an ETSI compliant "ADSL/POTS (FO)" modem. The reach predicted by this model, under the stress conditions of the associated ETSI ADSL specification (TS 101 388 [i.7]), is close to the minimum reach required by that ETSI specification (TS 101 388 [i.7]). Deviations between the predicted reach and this "benchmarked" reach are less than 100 m. The validity of the predicted performance holds for a wider range of stress conditions.

The receiver performance model for ETSI compliant "ADSL/POTS (FO)" is build-up from the following building blocks:

- A first order (linear) input model for the input block specified in clause 5.1.1, that combines all kinds of imperfections (front-end noise, residual echo and equalization errors), in one virtual noise source (P_{RNO}).
- The generic DMT detection model, specified in clause 5.2.4.
- The parameter values specified in table 65.

The parameter values, used in the receiver performance model for ETSI compliant "ADSL/POTS (FO)" modems, are summarized in table 65. Some of these are directly based on ADSL specifications. The remaining values are based on theory.

Table 65: Values for the performance parameters of the ADSL/POTS (FO) receiver model

Model parameter		DMT model		Remarks
		Upstream	Downstream	
SNR-Gap (effective)	Γ_{dB}	7,5 dB	7,5 dB	
SNR-Gap in parts	Γ_{DMT_dB}	9,75 dB	9,75 dB	
	Γ_{coding_dB}	4,25 dB	4,25 dB	
	Γ_{impl_dB}	2,0 dB	2,0 dB	
Receiver noise	P_{RNO_dB}	-120 dBm/Hz	-135 dBm/Hz	
Symbol rate	f_s	69/68 × 4 000 baud	69/68 × 4 000 baud	See clause 5.2.4
	f_{sd}	4 000 baud	4 000 baud	
Data rate	f_d	32 ... 640 kb/s	32 ... 6 144 kb/s	These are minimum ranges only; wider ranges are usually supported
Line rate	f_{bd}	$f_{bl} = f_d + 16 \times f_{sd}$ $f_{bh} = (f_d + 8 \times f_{sd}) \times 1,13$ $f_{bd} = \max(f_{bl}, f_{bh})$	$f_{bl} = f_d + 16 \times f_{sd}$ $f_{bh} = (f_d + 8 \times f_{sd}) \times 1,13$ $f_{bd} = \max(f_{bl}, f_{bh})$	See clause 5.2.4
	f_b	$f_b = 69/68 \times f_{bd}$	$f_b = 69/68 \times f_{bd}$	
Bits per symbol	b	f_{bd} / f_{sd}	f_{bd} / f_{sd}	
set of sub-carriers	$\{k\}$	$k \in [7:31]$	$k \in [7:63, 65:255]$	DMT tone $k = 64$ does not convey any bits because it is reserved as pilot tone.
Centre frequency location of tone k ; $k \in$ tones	f_k	$f_k = k \times \Delta f$ $\Delta f = 4,3125$ kHz	$f_k = k \times \Delta f$ $\Delta f = 4,3125$ kHz	
Bit-loading algorithm		FBL	FBL	See clause 5.2.4
Minimum bit-loading	b_{min}	2	2	Bits per tone per symbol
Maximum bit-loading	b_{max}	15	15	Bits per tone per symbol
NOTE 1: The relationship between line rate and data rate is a function of various modem settings, such as the use of trellis coding, interleaved mode, and framing parameters. The formulae in this table are a simplified model of this complex relationship.				
NOTE 2: The parameter values are for a modem in the interleaved mode.				

6.5 Receiver performance model for "ADSL/POTS (FDD)"

The receiver performance models for ETSI compliant "ADSL/POTS (FDD)" are build-up from the following building blocks:

- A first order (linear) input model for the input block specified in clause 5.1.1, that combines all kinds of imperfections (front-end noise, residual echo and equalization errors), in one virtual noise source (P_{RNO}).
- The generic DMT detection model, specified in clause 5.2.4.

This model is capable of evaluating the data rate (f_d), and uses the evaluation of the line rate (f_b) as intermediate step. In addition, the data rates (f_d) predicted by the model is to be limited to the maximum data rates (f_{d_max}) specified in table 66.

The parameter values, used in the receiver performance model for ETSI compliant "ADSL/POTS (FDD)" modems, are summarized in table 66. Some of these are directly based on ADSL specifications. The remaining values are extracted from ADSL/POTS (FDD) performance requirements or based on theory.

Table 66: Values for the performance parameters of the ADSL/POTS (FDD) receiver model

Model parameter		DMT model		Remarks
		Upstream	Downstream	
SNR-Gap (effective)	Γ_{dB}	9,0 dB	8,0 dB	
SNR-Gap in parts	Γ_{DMT_dB} Γ_{coding_dB} Γ_{impl_dB}	9,75 dB 4,25 dB 3,5 dB	9,75 dB 4,25 dB 2,5 dB	
Receiver noise	P_{RNO_dB}	-120 dBm/Hz	-140 dBm/Hz	
Symbol rate	f_s f_{sd}	69/68 × 4 000 baud 4 000 baud	69/68 × 4 000 baud 4 000 baud	See clause 5.2.4
Data rate	f_d f_{d_max}	32 kb/s ... f_{d_max} 800 kb/s (640 kb/s, see note 2)	32 kb/s ... f_{d_max} 8 192 kb/s (6 144 kb/s, see note 2)	Limit data rate to these maxima, if model predicts higher rates
Line rate	f_{bd} f_b	$f_{bl} = f_d + 16 \times f_{sd}$ $f_{bh} = (f_d + 8 \times f_{sd}) \times 1,13$ $f_{bd} = \max(f_{bl}, f_{bh})$ $f_b = 69/68 \times f_{bd}$	$f_{bl} = f_d + 16 \times f_{sd}$ $f_{bh} = (f_d + 8 \times f_{sd}) \times 1,13$ $f_{bd} = \max(f_{bl}, f_{bh})$ $f_b = 69/68 \times f_{bd}$	See clause 5.2.4, and note 3
Bits per symbol	b	f_{bd} / f_{sd}	f_{bd} / f_{sd}	
Default set of sub-carriers, for use with "adjacent transmitter model"	{ k }	$k \in [7:31]$	$k \in [33:63, 65:255]$	DMT tone $k = 64$ does not convey any bits because it is reserved as pilot tone
Alternative set of sub-carriers, for use with "guard-band transmitter model"	{ k }	$k \in [7:31]$	$k \in [38:63, 65:255]$	DMT tone $k = 64$ does not convey any bits because it is reserved as pilot tone
Centre frequency location of sub-carrier k ; ($k \in$ sub-carriers)	f_k	$f_k = k \times \Delta f$ $\Delta f = 4,3125$ kHz	$f_k = k \times \Delta f$ $\Delta f = 4,3125$ kHz	
Bit-loading algorithm		FBL	FBL	See clause 5.3.4
Minimum bit-loading	b_{min}	1 (see note 1)	1 (see note 1)	Bits per tone per symbol
Maximum bit-loading	b_{max}	15 (see note 1, note 2, and max data rate f_{d_max})	15 (see note 1, note 2 and max data rate f_{d_max})	Data rate should be limited to f_{d_max} if model predicts higher rates
<p>NOTE 1: The ADSL standard [i.8] specifies the bit-loading as integer values between 2 and 15, however the use of a model with "Fractional" bit-loading enables the use of non-integer values to account for other receiver properties as well. This enables the modelling of other receiver characteristics, as if the bit-loading caused them. Using a minimum bit-loading value of 1 instead of 2 is partially to account for absence of rounding in the FBL bit-loading and partially to account for increased bit-loading flexibility when modems operate with excess margin.</p> <p>In some cases it may be appropriate to use maximum upstream bit-loading lower than 15 in the models to account for imperfections commonly observed in real ADSL implementations.</p> <p>NOTE 2: The maximum data rate assumed for the first generation ADSL are 800 kb/s upstream and 8 192 kb/s downstream. In some cases these maximum values are limited to 640 kb/s upstream and 6 144 kb/s downstream. These limitations need to be considered when evaluating ADSL performance.</p> <p>NOTE 3: The correction factor 1.13 represents the Reed Solomon coding overhead, and is connected with the coding gain of 4,25 dB.</p> <p>NOTE 4: The relationship between line rate and data rate is a function of various modem settings, such as the use of trellis coding, interleaved mode, and framing parameters. The formulae in this table are a simplified model of this complex relationship.</p> <p>NOTE 5: The parameter values are for a modem in the interleaved mode.</p>				

6.6 Receiver performance model for "ADSL/ISDN (FO)"

This calculation model is capable of predicting a performance that is benchmarked against the performance requirements of an ETSI compliant "ADSL/ISDN (FO)" modem. The reach predicted by this model, under the stress conditions of the associated ETSI ADSL specification (TS 101 388 [i.7]), is close to the minimum reach required by that ETSI specification (TS 101 388 [i.7]). Deviations between the predicted reach and this "benchmark" reach are in most cases less than 80 m. The validity of the predicted performance holds for a wider range of stress conditions.

The receiver performance model for ETSI compliant "ADSL/ISDN (FO)" is build-up from the following building blocks:

- A first order (linear) input model for the input block specified in clause 5.1.1, that combines all kinds of imperfections (front-end noise, residual echo and equalization errors), in one virtual noise source (P_{RNO}).
- The generic DMT detection model, specified in clause 5.2.4.
- The parameter values specified in table 67.

The parameter values, used in the receiver performance model for ETSI compliant "ADSL/ISDN (FO)" modems, are summarized in table 67. Some of these are directly based on ADSL specifications. The remaining values are based on theory.

Table 67: Values for the performance parameters of the ADSL/ISDN (FO) receiver model

Model parameter		DMT model		Remarks
		Upstream	Downstream	
SNR-Gap (effective)	Γ_{dB}	7,8 dB	7,5 dB	
SNR-Gap in parts	Γ_{DMT_dB}	9,75 dB	9,75 dB	
	Γ_{coding_dB}	4,25 dB	4,25 dB	
	Γ_{impl_dB}	2,3 dB	2,0 dB	
Receiver noise	P_{RNO_dB}	-120 dBm/Hz	-135 dBm/Hz	
Symbol rate	f_s	69/68 × 4 000 baud	69/68 × 4 000 baud	See clause 5.2.4
	f_{sd}	4 000 baud	4 000 baud	
Data rate	f_d	32 ... 640 kb/s	32 ... 6 144 kb/s	These are minimum ranges only; wider ranges are usually supported
Line rate	f_{bd}	$f_{bl} = f_d + 16 \times f_{sd}$ $f_{bh} = (f_d + 8 \times f_{sd}) \times 1,13$ $f_{bd} = \max(f_{bl}, f_{bh})$	$f_{bl} = f_d + 16 \times f_{sd}$ $f_{bh} = (f_d + 8 \times f_{sd}) \times 1,13$ $f_{bd} = \max(f_{bl}, f_{bh})$	See clause 5.2.4
	f_b	$f_b = 69/68 \times f_{bd}$	$f_b = 69/68 \times f_{bd}$	
Bits per symbol	b	f_{bd} / f_{sd}	f_{bd} / f_{sd}	
set of sub-carriers	$\{k\}$	$k \in [33:63]$	$k \in [33:95, 97:255]$ <i>Tone 96 = pilot tone</i>	<i>DMT tone k = 96 does not convey any bits because it is reserved as pilot tone.</i>
Centre frequency location of tone k; $k \in \text{tones}$	f_k	$f_k = k \times \Delta f$ $\Delta f = 4,3125 \text{ kHz}$	$f_k = k \times \Delta f$ $\Delta f = 4,3125 \text{ kHz}$	
Bit-loading algorithm		FBL	FBL	See clause 5.2.4
Minimum bit-loading	b_{min}	2	2	Bits per tone per symbol
Maximum bit-loading	b_{max}	15	15	Bits per tone per symbol
NOTE 1: The relationship between line rate and data rate is a function of various modem settings, such as the use of trellis coding, interleaved mode, and framing parameters. The formulae in this table are a simplified model of this complex relationship.				
NOTE 2: The parameter values are for a modem in the interleaved mode.				

6.7 Receiver performance model for "ADSL/ISDN (FDD)"

The downstream receiver performance model for ETSI compliant "ADSL/ISDN (FDD)" is build-up from the following building blocks:

- A first order (linear) input model for the input block specified in clause 5.1.1, that combines all kinds of imperfections (front-end noise, residual echo and equalization errors), in one virtual noise source (P_{RN0}).
- The generic DMT detection model, specified in clause 5.2.4.

This model is capable of evaluating the data rate (f_d), and uses the evaluation of the line rate (f_b) as intermediate step. In addition, the data rates (f_d) predicted by the model is to be limited to the maximum data rates (f_{d_max}) specified in table 68.

The parameter values, used in the receiver performance model for ETSI compliant "ADSL/ISDN (FDD)" modems, are summarized in table 68. Some of these are directly based on ADSL specifications. The remaining values are extracted from the ADSL/ISDN (FDD) performance requirements or based on theory.

Table 68: Values for the performance parameters of the ADSL/ISDN (FDD) receiver model

Model parameter		DMT model		Remarks
		Upstream	Downstream	
SNR-Gap (effective)	Γ_{dB}	8,0 dB	7,0 dB	
SNR-Gap in parts	Γ_{DMT_dB}	9,75 dB	9,75 dB	
	Γ_{coding_dB}	4,25 dB	4,25 dB	
	Γ_{impl_dB}	2,5 dB	1,5 dB	
Receiver noise	P_{RNO_dB}	-120 dBm/Hz	-140 dBm/Hz	
Symbol rate	f_s	69/68 × 4 000 baud	69/68 × 4 000 baud	See clause 5.2.4
	f_{sd}	4 000 baud	4 000 baud	
Data rate	f_d	32 kb/s ... f_{d_max}	32 kb/s ... f_{d_max}	
	f_{d_max}	800 kb/s (640 kb/s, see note 2)	8 192 kb/s (6 144 kb/s, see note 2)	Limit data rate to these maxima, if model predicts higher rates
Line rate	f_{bd}	$f_{bl} = f_d + 16 \times f_{sd}$ $f_{bh} = (f_d + 8 \times f_{sd}) \times 1,13$ $f_{bd} = \max(f_{bl}, f_{bh})$	$f_{bl} = f_d + 16 \times f_{sd}$ $f_{bh} = (f_d + 8 \times f_{sd}) \times 1,13$ $f_{bd} = \max(f_{bl}, f_{bh})$	See clause 5.2.4 and note 3
	f_b	$f_b = 69/68 \times f_{bd}$	$f_b = 69/68 \times f_{bd}$	
Bits per symbol	b	f_{bd} / f_{sd}	f_{bd} / f_{sd}	
Default set of sub carriers, for use with "adjacent transmitter model"	$\{k\}$	$k \in [33:63]$	$k \in [64:95, 97:255]$	DMT tone $k = 96$ does not convey any bits because it is reserved as pilot tone
		see note 4	see note 4	
Alternative set of sub carriers, for use with "guard band transmitter model"	$\{k\}$	$k \in [33:56]$	$k \in [64:95, 97:255]$	DMT tone $k = 96$ does not convey any bits because it is reserved as pilot tone
		see note 4	see note 4	
Centre frequency location of sub-carrier k ; ($k \in$ sub-carrier)	f_k	$f_k = k \times \Delta f$ $\Delta f = 4,3125$ kHz	$f_k = k \times \Delta f$ $\Delta f = 4,3125$ kHz	
Bit-loading algorithm		FBL	FBL	See clause 5.2.4
Minimum bit-loading	b_{min}	1 (see note 1)	1 (see note 1)	Bits per tone per symbol
Maximum bit-loading	b_{max}	15 (see note 1, note 2, and max data rate f_{d_max})	15 (see note 1, note 2 and max data rate f_{d_max})	Data rate should be limited to f_{d_max} if model predicts higher rates
<p>NOTE 1: The ADSL standard [i.8] specifies the bit-loading as integer values between 2 and 15, however the use of a model with "Fractional" bit-loading enables the use of non-integer values to account for other receiver properties as well. This enables the modelling of other receiver characteristics, as if the bit-loading caused them. Using a minimum bit-loading value of 1 instead of 2 is partially to account for absence of rounding in the FBL bit-loading and partially to account for increased bit-loading flexibility when modems operate with excess margin.</p> <p>In some cases it may be appropriate to use maximum upstream bit-loading lower than 15 in the models to account for imperfections commonly observed in real ADSL implementations.</p> <p>NOTE 2: The maximum data rate assumed for the first generation ADSL are 800 kb/s upstream and 8 192 kb/s downstream. In some cases these maximum values are limited to 640 kb/s upstream and 6 144 kb/s downstream. These limitations need to be considered when evaluating ADSL performance.</p> <p>NOTE 3: The correction factor 1.13 represents the Reed Solomon coding overhead, and is connected with the coding gain of 4,25 dB.</p> <p>NOTE 4: The available set of tones, according to the standard, is somewhat wider and ranges for upstream $k \in [33:64]$, and for downstream $k \in [60:95, 97:255]$. However this was not intended to be used in overlap.</p> <p>NOTE 5: The relationship between line rate and data rate is a function of various modem settings, such as the use of trellis coding, interleaved mode, and framing parameters. The formulae in this table are a simplified model of this complex relationship.</p> <p>NOTE 6: The parameter values are for a modem in the interleaved mode.</p>				

6.8 Receiver performance model for "VDSL"

NOTE: This model is left for further study.

7 Transmission and reflection models

7.1 Summary of test loop models

Over the years, a variety of two-port models have been extracted from cable measurements up to 30 MHz, and published in several documents. These models are so numerous due to the wide range of cables being used in different countries.

An example of a two-port models of a 100 Ω cable and of a 150 Ω cable can be found in the VDSL1 specification (TS 101 270-1 [i.11], annex A).

NOTE: Other examples of two-port cable models can be found in ETSI specifications for SDSL (TS 101 524 [i.5]) and ADSL (TS 101 388 [i.7]), however they are not defined up to the full 30 MHz band.

8 Crosstalk models

Crosstalk is commonly a dominant contributor to the overall disturbance that impairs a transmission. Crosstalk models are to evaluate how much crosstalk originates from various disturbers that are distributed over the local loop wiring. In practice this is not restricted to a one-dimensional cable topology, since wires may fan out into different directions to connect for instance different customers to a central office.

This clause summarizes basic models for evaluating crosstalk in various scenarios. The models are presented here as individual building blocks, but a full analysis requires the use of a combination of these blocks.

8.1 Basic models for crosstalk cumulation

Cumulation models relate the crosstalk powers generated by multiple disturbers with the *number* and *type* of these disturbers.

The meaning of *the* crosstalk power is not obvious. When a cable with N wire pairs is filled-up completely with similar disturbers, the resulting crosstalk power in each wire-pair (from $N-1$ disturbers connected to the other wire-pairs) is maximal and therefore unambiguous. This upper limit is the saturated crosstalk power for that type of disturber, for that particular wire-pair.

However if the number M of disturbers is lower ($M < N-1$), this crosstalk power will commonly change when another combination of M wire-pairs will be chosen. So an exact expression for the resulting crosstalk, as function of the *number* and *type* of disturbers, does not exist if it remains unknown to which wire-pairs they are connected.

What does exist are crosstalk powers that occur with a certain probability. To illustrate that, consider an experiment that connects 30 disturbers to a cable with 100 wire pairs in 100 000 different ways. If the resulting noise is observed in one particular wire-pair, it is most likely that 100 000 different crosstalk noise powers will be observed. The result of such a "probability experiment" is therefore not a single power, but a (wide) range of powers with a certain probability distribution.

Within this range, a certain crosstalk noise power can be found that is not exceeded in 99 % of the cases (or 80 % or 65 % or whatsoever). That power level is named a *probability limit* for a particular wire pair.

A cumulation model predicts how such a *limit* (at given probability) behaves as a function of number and type of disturbers. The use of 99 % worst case limits is commonly used. When a study evaluates the performance under a noise power that equals such a probability limit, then the actual performance will in "most cases" be better than predicted in this way. The use of 100 % worst case limits is commonly avoided, to prevent for over-pessimistic analyses.

8.1.1 Uniform cumulation model

The uniform cumulation model is restricted to the special case that all disturbers are from the same type. It assumes that the probability limit from M disturbers is proportional with M^{1/K_n} , where K_n is an empirical parameter (values like $K_n=1/0,6$ are commonly used for 99 % worst case analyses).

Expression 14 shows this uniform cumulation model. It uses a frequency dependent quantity P_{Xd} (the *normalized crosstalk power*) as intermediate result, that has been derived from the saturated crosstalk power (maximum cross talk power at 100 % cable fill), for that particular type of disturber.

This saturated crosstalk power will most likely be different for each individual wire-pair, but a worst case value of all wire-pairs could be selected if a cable is to be modelled as a whole. Hence expression 1 can be applied to predict probability limits in either a single wire-pair or in a cable as a whole. The difference is that in the latter case $P_X(N-1, f)$ is the saturated crosstalk power in the worst-case wire-pair (having the highest saturated value) and that $P_X(M, f)$ represents a statistical value (e.g. a 99 % worst case value) taken from much more values than in the single wire-pair case.

The reliability of the model improves when $M \gg 1$. By definition, the model provides an exact value for the crosstalk power experienced within a specific victim wire-pair when $M=(N-1)$.

$P_X(M, f) = M^{1/K_n} \times P_{Xd}(f) \quad \text{with } P_{Xd}(f) \stackrel{\text{def}}{=} \frac{P_X(N-1, f)}{(N-1)^{1/K_n}}$	
N M $P_X(M, f)$ $P_X(N-1, f)$ $P_{Xd}(f)$ K_n f	= number of wire pairs in the cable = number of similar disturbers ($1 \leq M \leq N-1$) = probability limit of crosstalk from M similar disturbers = saturated crosstalk power (at a complete cable fill) = normalized crosstalk power, for that particular disturber type = empirical constant ($K_n=1/0,6$ is commonly used) = frequency

Expression 14: Definition of the uniform cumulation model

NOTE: For some cables used in the Netherlands, it has been observed that a slightly different value for K_n provides a better fit with measurements on these cables. For instance, values between 1/0,6 and 1/0,8 have been observed. For those cables, these values for K_n may be more appropriate for use in expression 14 and associated expressions.

8.1.2 FSAN sum for crosstalk cumulation

The FSAN sum is a cumulation model that is also applicable when different disturbers are involved. It is a generalization of the uniform cumulation model, and is specified in expression 15. The (frequency dependent) probability limit of the crosstalk, caused by M individual disturbers, is expressed below.

$P_X(M, f) = \left(P_{Xd,1}(f)^{K_n} + P_{Xd,2}(f)^{K_n} + P_{Xd,3}(f)^{K_n} + \dots + P_{Xd,M}(f)^{K_n} \right)^{1/K_n}, \quad \text{with } K_n = \frac{1}{0,6}$	
M	= number of involved disturbers
$P_X(M, f)$	= probability limit of crosstalk from those M disturbers
$P_{Xd,k}(f)$	= normalized crosstalk power, for disturber k , as defined in expression 14
K_n	= empirical constant ($K_n=1/0,6$ is used for the FSAN sum)
f	= frequency

Expression 15: FSAN sum for cumulating the power levels of M individual disturbers into the power level of an equivalent disturber

Factor K_n is assumed to be frequency independent. In the special case that all M disturbers generates equal power levels (P_{Xd}) at all frequencies of interest, the FSAN sum simplifies into $P_X(M, f) = P_{Xd}(f) \times M^{1/K_n}$. This demonstrates consistency with the uniform cumulation model.

The FSAN sum operates directly on powers, and ignores the existence of source and termination impedances. If different impedances are involved (due to different disturber and victim types), their *available* power levels are to be combined according to the FSAN sum. Available power of a source is the power dissipated in a load resistance, equal to its source impedance.

8.2 Basic models for NEXT and FEXT coupling

These sub-models for crosstalk coupling are to evaluate the normalized crosstalk power, as defined before in expression 14, that a single disturbing modem pair couples into a specific (other) wire-pair in the cable. However, it should be noted that the models in this clause are restricted to *normalized* crosstalk coupling only, and are not intended for evaluating the *actual* crosstalk coupling between two individual wire-pairs. The actual coupling fluctuates rapidly with the frequency and changes significantly per wire-pair combination. Therefore the ratio between *normalized* crosstalk amplitude (measured at 100 % cable fill, and subsequently normalized to a single disturber) and the disturber amplitude is being modelled.

The models for topologies with multiple disturber pairs are derived from these basic models.

- NEXT-coupling refers to the transfer function between ends of different pairs at the same cable section side ("near-end").
- FEXT-coupling refers to the transfer function between ends of different pairs at the opposite cable section sides ("far-end").

When P_d represents the (frequency dependent) transmit power of the involved disturber, and P_{Xd} represents the (frequency dependent) normalized crosstalk power (scaled down from the saturated crosstalk power at 100 % cable fill), then this ratio becomes as shown below in expression 16:

$$H(f) = \text{normalized crosstalk coupling} = \sqrt{\frac{\text{normalized crosstalk power}}{\text{disturber power}}} = \sqrt{\frac{P_{Xd}(f)}{P_d(f)}}$$

Expression 16: Definition of normalized crosstalk coupling function

The normalized crosstalk coupling is dependent from the wire-pair being connected to the victim modem pair. A possible approach for modelling coupling in cables as a *whole*, is to find the normalized crosstalk power (for a chosen disturber type) in each of the N wire pairs of the cable, and then to find (for each frequency) the 99 % worst case value of those N powers.

8.2.1 Normalized NEXT and FEXT coupling at an elementary cable section

The normalized coupling models for co-located NEXT and FEXT are restricted to the special case of an elementary cable section topology, as illustrated in figure 10. The LT side of a disturbing modem pair is in such a topology co-located with the LT-side of a victim modem, and the same applies to the NT side. It means that the two involved wire-pairs are coupled over the full length of that (elementary) cable or cable section.



Figure 10: Example of a two-node cable section topology

Expression 17 specifies the transfer functions of this normalized NEXT and FEXT coupling model. The termination impedances of the wire-pairs are fully ignored in this model, and all wire-pairs are assumed to be terminated by the *characteristic* impedance Z_0 of the cable. By doing so, a cascade of two loops can easily be evaluated by multiplying their respective characteristic transmissions, without bothering impedances.

$H_{next}(f, L) = K_{xn} \times \left(\frac{f}{f_0} \right)^{0,75} \times \sqrt{1 - s_T(f, L) ^4}$ $H_{fext}(f, L) = K_{xf} \times \left(\frac{f}{f_0} \right) \times \sqrt{L/L_0} \times s_T(f, L) $
<p>NOTE 1: Parameter f refers to the frequency. Constant f_0 identifies a chosen reference frequency, commonly set to $f_0 = 1$ MHz.</p> <p>NOTE 2: Parameter L refers to the coupling length of the wirepairs. Constant L_0 identifies a chosen reference length, commonly set to $L_0 = 1$ km.</p> <p>NOTE 3: Values for K_{xn} and K_{xf} are cable specific, and are to be specified for each scenario being studied. Commonly used values (in dB) for generic European studies, not dedicated to any particular cable or region, are: $K_{xn_dB} = -50$ dB and $K_{xf_dB} = -45$ dB for $f_0 = 1$ MHz and $L_0 = 1$ km.</p> <p>NOTE 4: Function $s_T(f, L)$ represents the frequency and length dependent characteristic transmission of the wire pairs. This equals the insertion loss when the cable is terminated at both ends with its characteristic impedance.</p>

Expression 17: Transfer functions of co-located normalized NEXT and FEXT coupling

8.2.2 Normalized NEXT and FEXT coupling at distributed or branched cables

When crosstalk from a disturbing modem pair originates from locations that are not co-located with the victim modem pair, the two involved wire-pairs are not coupled over the full length. An example topology occurs when a victim modem-pair operates between cabinet and customer premises while a disturbing modem pair operates between central office and customer premises. Another example topology occurs when a cable is branched to different (customer) locations, from a certain point in the loop. Both examples are illustrated in figure 11.

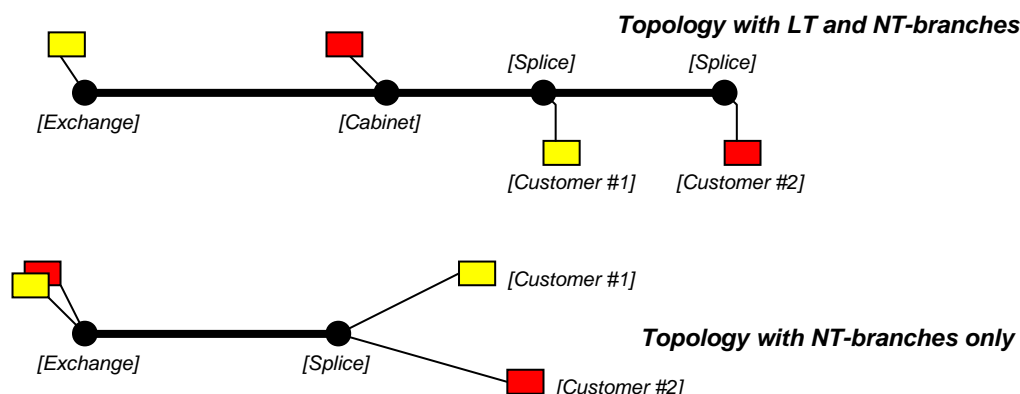

Figure 11: Two example topologies with branching

In all these distributed or branched examples, the interaction between disturbers and victims can be characterized by a common section that couples signals, and four independent sections (branches) that are attenuating signals only. This is illustrated in figure 12. Branches may have zero length in special topologies.

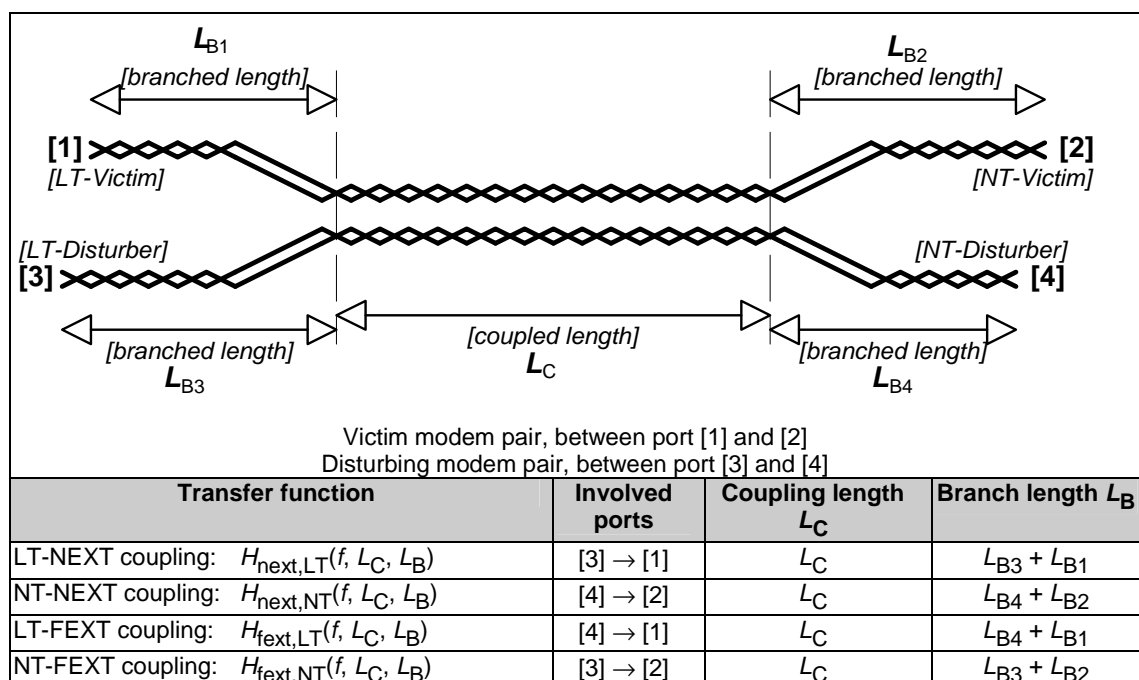

Figure 12: Example of the lengths that are to be used for evaluating branched normalized NEXT and FEXT

The expressions for branched normalized crosstalk coupling are not so different from the co-located case. They mainly differ by the fact that *two* length values are involved instead of one: the coupling length L_C and the total branch length L_B . The branched model is simply derived from the co-located model, by incorporating the additional attenuation of these branches.

The table in figure 12 summarizes what the total branch length is for each combination of ports. The associated transfer functions from a disturbing transmitter to a victim modem are shown in expression 18. If $L_B=0$, the expressions simplify in those for the co-located case, and this demonstrates consistency between the two models.

This model assumes a single cable type, so that branch length could be added to the coupling length to account for its insertion loss. If this is not the case, the insertion losses of the branches have to be evaluated individually.

$H_{next}(f, L_C, L_B) = K_{xn} \times \left(\frac{f}{f_0}\right)^{0,75} \times \sqrt{1 - s_T(f, L_C) ^4} \times s_T(f, L_B) $ $H_{fext}(f, L_C, L_B) = K_{xf} \times \left(\frac{f}{f_0}\right) \times \sqrt{L_C / L_0} \times s_T(f, L_C + L_B) $
<p>NOTE 1: Parameter f refers to the frequency. Constant f_0 identifies a chosen reference frequency, commonly set to $f_0 = 1$ MHz.</p> <p>NOTE 2: Parameter L_C refers to the coupling length between the wire pair connected to the disturbing transmitter and the wire pair connected to the victim receiver. It represents the length they share in the same cable. Constant L_0 identifies a chosen reference length, commonly set to $L_0 = 1$ km.</p> <p>NOTE 3: Parameter L_B refers to the respective branching length (for adding signal attenuation only) from a disturbing transmitter to a victim receiver.</p> <p>NOTE 4: Values for K_{xn} and K_{xf} are cable specific, and are to be specified for each scenario being studied. Commonly used values (in dB) for generic European studies, not dedicated to any particular cable or region, are: $K_{xn_dB} = -50$ dB and $K_{xf_dB} = -45$ dB for $f_0 = 1$ MHz and $L_0 = 1$ km.</p> <p>NOTE 5: Function $s_T(f, L)$ represents the frequency and length dependent characteristic transmission of the wire pairs. This would be the insertion loss when the cable is terminated at both ends with its characteristic impedance.</p>

Expression 18: Transfer functions of branched normalized NEXT and FEXT coupling

8.3 Basic models for crosstalk injection

These sub-models are applicable to studies where the noise level has to be adjusted for impedance mismatch. When the impedance of the victim modem changes, the noise (and signal) observed by the receiver will change as well. To account for this effect, a crosstalk injection block can be included in a topology models.

The transfer function of the crosstalk injection block identified as H_{xi} , and is frequency and impedance dependent. Expression 19 illustrates how to use this transfer function for evaluating the power level P_{RN} from power level P_{XN} .

$$P_{RN} = P_{XN} \times |H_{xi}|^2$$

Expression 19: Evaluation of the receive noise level from the crosstalk noise level under matched conditions, by a transfer function of the noise injector

A transfer function that models the impact of impedance mismatch can be very complex, and therefore several simplified transfer functions are commonly used to approximate this effect. This clause summarizes a few of these approximations.

8.3.1 Forced noise injection

When crosstalk injection is modelled by means of *forced* noise injection, then all impedance and frequency dependency of noise injection is ignored. The associated transfer function is shown in expression 20.

$$H_{xi}(f) = 1$$

Expression 20: Transfer function for forced noise injection

8.3.2 Current noise injection

When crosstalk injection is modelled by means of *current* noise injection, then it is assumed that the impedance dependency can be represented by the equivalent circuit diagram shown in figure 13. The associated transfer function is shown in expression 21.

- The *injection condition* holds when the performance is evaluated. Impedance Z_{LX} represents the cable with its terminating impedance at the other ends of the line. Z_{LX} is usually a frequency dependent and complex impedance.
- The *calibration condition* holds for the situation that noise has been evaluated. Z_{cal} should be a well-defined impedance. This can be a complex artificial impedance approximating Z_{LX} , or simply a fixed real impedance. In the special case that $Z_{cal} \equiv Z_{LX}$, the concept of "current injection" simplifies into "forced injection" as described in the previous clause.

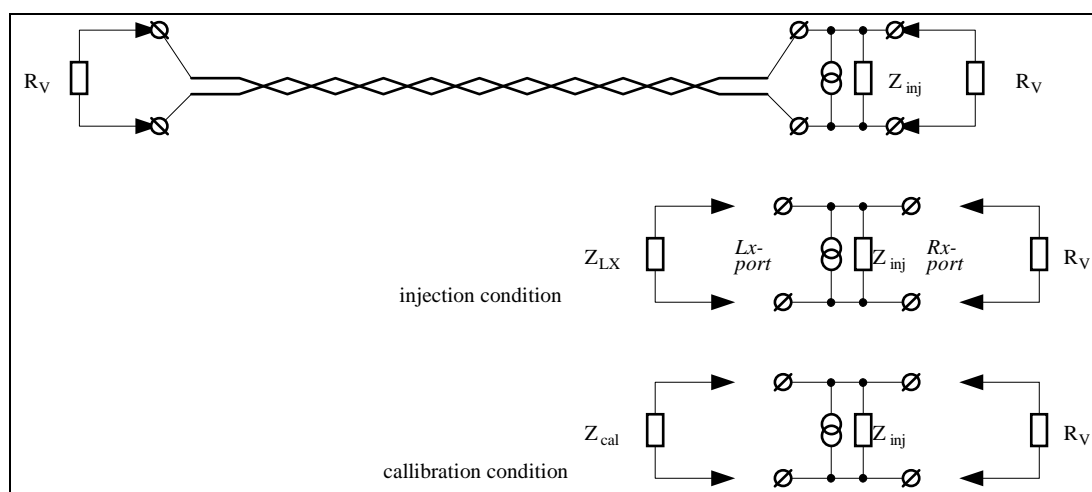

Figure 13: Current injection enables modelling of the impedance dependent behaviour of crosstalk noise levels

The transfer function $H_{xi}(f) = (U_i/U_c)$ between (a) the signal voltage U_i over impedance R_V during injection condition, and (b) U_c during calibration condition, equals:

$$H_{xi}(f, Z_{LX}) = \left(\frac{1/Z_{cal} + 1/Z_{inj} + 1/R_V}{1/Z_{LX} + 1/Z_{inj} + 1/R_V} \right)$$

Expression 21: Transfer function to model impedance dependency according to the current injection method

8.4 Overview of different network topologies

The results of spectral management studies are highly dependent on the chosen network topology, which is very country and location specific. The most simple topology models assume that all disturbers are co-located at only two locations; one at each end of a cable. This approximation is computational convenient but is generally inadequate to represent the real world. For example it will conceal effects due to fan out of the wires (relevant for short loops), and due to secondary NEXT.

More advanced topology models require a multi-node co-location approach. An example is the insertion of repeaters that introduces co-located disturbers in-between. Another example is deploying VDSL from the cabinet for the situation that all customers are distributed along the cable. It is recommended to use a multi-node approach, because this makes the simulation more realistic. A two-node approach implies that all NT disturbers are virtually co-located, and this is too pessimistic. This may cause pessimistic downstream results.

In practice topologies are not restricted to a linear cable topology, since wires may fan out into different directions to connect for instance different customers to a central office. This requires a branched multi-node approach. In the current version of the present document, only the most simple topology (with two nodes) has been elaborated, while the description of more advanced topology models is left for further study.

8.5 Crosstalk evaluation for multi-node topologies

If a victim modem pair is impaired by disturbers from all kinds of locations, the evaluation of the crosstalk probability limits may be rather complex. Figure 14 shows an example of the wiring in a multi-node topology.

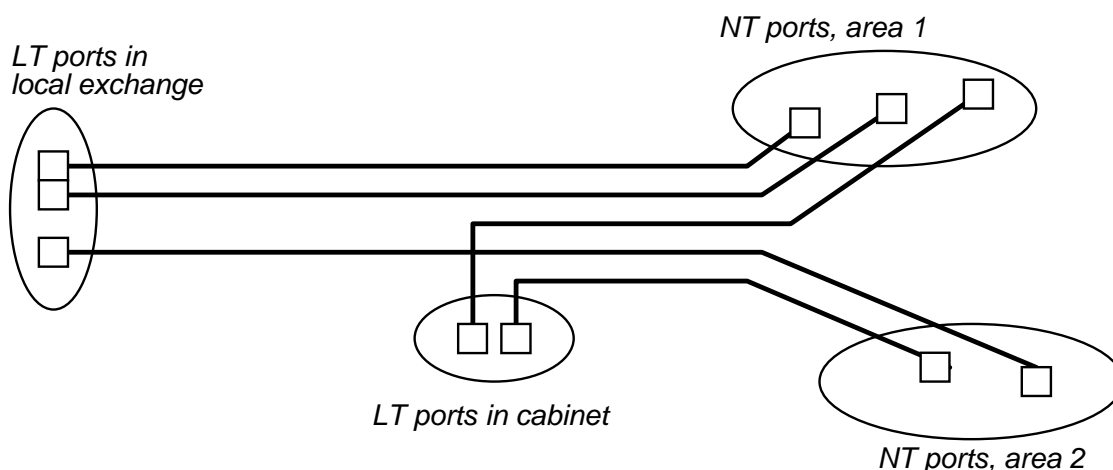

Figure 14: Example of the wiring in a multi-node topology

Essentially, this example with five wire pairs is a combination of four individual couplings between a disturbing modem pair and the victim modem pair. Each coupling function can be different (in coupling length, in branching length, etc). By evaluating these individual coupling functions one by one, the probability limits of the crosstalk from all involved disturbers can be derived.

The probability limit $P_{XN,NT}$ of the crosstalk power at the NT side of a victim modem pair, and the associated probability limit $P_{XN,LT}$ at the other side, can be evaluated as follows:

- First, evaluate for each individual disturber pair $\{k\}$, the four normalized crosstalk coupling functions between the two disturbers and the two victims. Appropriated models are provided in expression 18. When disturbers are not co-located with other disturbers, the coupling and branching lengths may be different for each disturber pair.
- Then, evaluate for each individual disturber pair $\{k\}$ the normalized crosstalk power $P_{Xd\{k\}}$ from the transmit power $P_{d\{k\}}$ of the involved disturber. This is formulated below at both victim modems:

$$\begin{aligned}
 \text{Normalized NEXT at NT-side:} & \quad P_{XN,d\{k\},NT} = P_{d\{k\},NT} \times |H_{\text{next}\{k\},NT}|^2 \\
 \text{Normalized NEXT at LT-side:} & \quad P_{XN,d\{k\},LT} = P_{d\{k\},LT} \times |H_{\text{next}\{k\},LT}|^2 \\
 \text{Normalized FEXT at NT-side:} & \quad P_{XF,d\{k\},NT} = P_{d\{k\},LT} \times |H_{\text{fext}\{k\},NT}|^2 \\
 \text{Normalized FEXT at LT-side:} & \quad P_{XF,d\{k\},LT} = P_{d\{k\},NT} \times |H_{\text{fext}\{k\},LT}|^2
 \end{aligned}$$

- Next, cumulate all these normalized individual NEXT powers with an appropriated cumulation model (for instance the FSAN sum in expression 15) into a probability limit of the NEXT.
- Do the same for normalized FEXT powers.
- Finally add both powers. If direct disturbers ($P_{bn,NT}$ and $P_{bn,LT}$) are also involved (like systems sharing the same wire pair in another frequency band), then they can be added here as well.

Expression 22 evaluates the probability limit of the crosstalk at each receiver as explained above, in the case that FSAN summing is applied for the cumulation, and direct disturbers are involved at both sides.

$$P_{XN,NT} = \left(\sum_{k=1}^M \left(P_{d\{k\},NT} \times |H_{next\{k\},NT}|^2 \right)^{Kn} \right)^{1/Kn} + \left(\sum_{k=1}^M \left(P_{d\{k\},LT} \times |H_{fext\{k\},LT}|^2 \right)^{Kn} \right)^{1/Kn} + P_{bn,NT}$$

$$P_{XN,LT} = \left(\sum_{k=1}^M \left(P_{d\{k\},LT} \times |H_{next\{k\},LT}|^2 \right)^{Kn} \right)^{1/Kn} + \left(\sum_{k=1}^M \left(P_{d\{k\},NT} \times |H_{fext\{k\},NT}|^2 \right)^{Kn} \right)^{1/Kn} + P_{bn,LT}$$

NOTE 1: Power $P_{d\{k\}}$ represents the transmit power of an involved disturber k , and M represents the total number of involved disturbers in the cable.

NOTE 2: All involved powers P and coupling functions H are assumed to be frequency dependent, but this has been omitted to simplify the above expressions.

Expression 22: Evaluation of the probability limit of the crosstalk at each receiver

8.6 Crosstalk evaluation for two-node topologies

In the special (simplified) case that all disturbers are co-located with one of the two victim modems, the generalized approach in expression 22 can be simplified significantly. Such an approach can be applicable to scenarios with long distribution cables in which all customers can be regarded as virtually co-located (compared to the length of the distribution cable). Since they are all served from the same central office, the topology requires only two nodes (one on the LT side, and another one on the "common" NT side).

Figure 15 shows an example of the wiring in such a two-node topology.

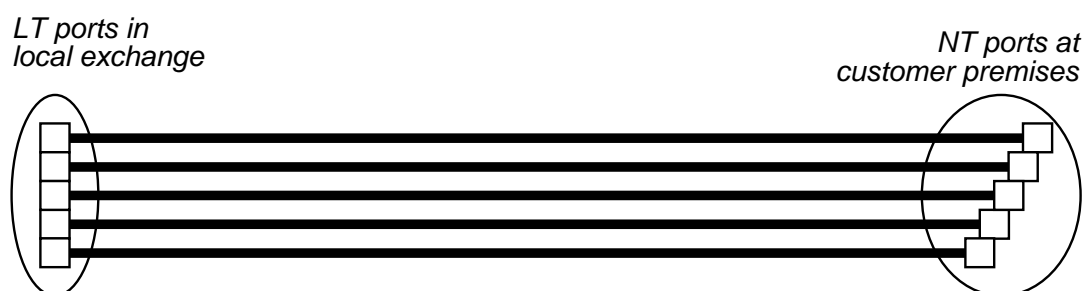

Figure 15: Example of the wiring in a two-node topology, where all wire-pairs are assumed to be of equal length

An additional characteristic of two-node topologies is that all the NEXT coupling functions in expression 22 are assumed equal, and that the same applies for the FEXT coupling functions. The result is that the previous expression 22 for crosstalk simplifies into expression 23. By combining the powers $P_{d\{k\}}$ from all co-located disturbers into a single equivalent disturber $P_{d,eq}$ at that location, the crosstalk expression simplifies even further as shown in expression 24.

$$P_{XN,NT} = \left(\sum_k \left(P_{d\{k\},NT} \right)^{Kn} \right)^{1/Kn} \times |H_{next}|^2 + \left(\sum_k \left(P_{d\{k\},LT} \right)^{Kn} \right)^{1/Kn} \times |H_{fext}|^2 + P_{bn,NT}$$

$$P_{XN,LT} = \left(\sum_k \left(P_{d\{k\},LT} \right)^{Kn} \right)^{1/Kn} \times |H_{next}|^2 + \left(\sum_k \left(P_{d\{k\},NT} \right)^{Kn} \right)^{1/Kn} \times |H_{fext}|^2 + P_{bn,LT}$$

Expression 23: Simplified version of expression 22, for the special case that all NEXT and all FEXT couplings are the same

$P_{d.eq} \stackrel{def}{=} \left(\sum_k (P_{d\{k\}})^{Kn} \right)^{1/Kn} \quad (\text{for each end of the cable})$ $P_{XN,NT} = P_{d.eq,NT} \times H_{next} ^2 + P_{d.eq,LT} \times H_{fext} ^2 + P_{bn,NT}$ $P_{XN,LT} = P_{d.eq,LT} \times H_{next} ^2 + P_{d.eq,NT} \times H_{fext} ^2 + P_{bn,LT}$
<p>NOTE: All involved powers P and coupling functions H are assumed to be frequency dependent, but this has been omitted for simplifying the above expressions.</p>

Expression 24: Evaluation of the crosstalk from two locations

A convenient way of presenting the evaluation of the various crosstalk powers is the use of a flow diagram. This is shown in figure 16 (for downstream) and 17 (for upstream) for the two-node topology. It illustrates how the various building blocks of expression 24 work together when deriving the probability limits of the crosstalk.

The flow diagram illustrates that the crosstalk can be evaluated in steps.

- The diagram combines for each end of the cable the disturber output powers (P_{d1}, P_{d2}, \dots) into a single equivalent disturber ($P_{d.eq}$), as if the cumulation operates directly on these disturber powers. This has been illustrated in figures 16 and 17 by a box drawn around the involved building blocks. Using the equivalent disturber concept as intermediate result yields an elegant concept to break down the complexity of a full noise scenario into smaller pieces, but works only for two-node topologies.
- Next, the diagram evaluates the probability limit of the crosstalk noise (P_{XN}), that is coupled into the wire pair of the victim modem being studied. Figures 16 and 17 illustrate what portion of the equivalent disturbance is coupled into that wire pair by using models for (co-located) normalized NEXT and FEXT.
- If direct disturbers are involved, their power (P_{bn}) can be added to the probability limit of the crosstalk noise. Such a direct disturber can be used to represent for instance:
 - (a) line shared noise (from POTS/ISDN to ADSL);
 - (b) all kinds of unidentified ("background") noise sources; or
 - (c) anything else not being incorporated in the NEXT and FEXT coupling models.
- Since it is a generic diagram, the power of this direct noise is left undefined here. Commonly used values are zero, or powers as low as $P_{bn} = -140$ dBm/Hz.

Mark that the impedance of each disturber is fully ignored in this evaluation of the crosstalk. In practice however, the impedance of a victim modem may be different for different types of victim modems. This is not as unrealistic as it may look at a first glance. When the received noise power is assumed to remain at constant level, and when the impedance of the victim modem drops, then the received noise voltage drops too. The same applies for the received signal, and this causes that the resulting changes in received signal-to-noise ratio are significantly lower. The noise injection model can be used to improve this even further, by introducing an additional impedance-dependency.

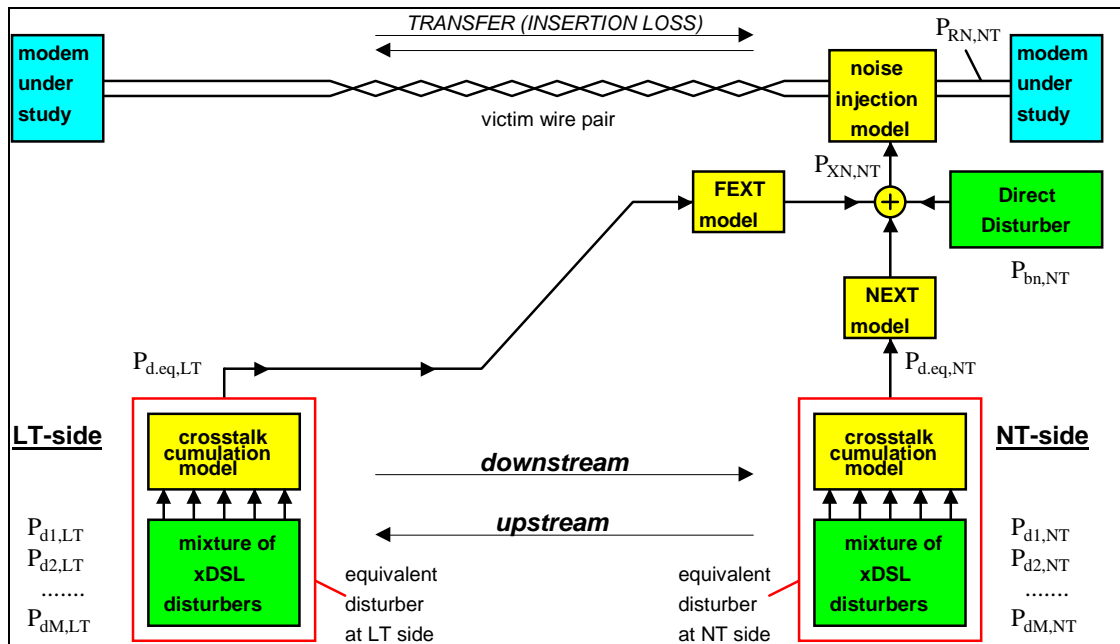

Figure 16: Flow diagram to evaluate crosstalk probability limits for two-node topologies, at the NT side (for evaluating downstream performance)

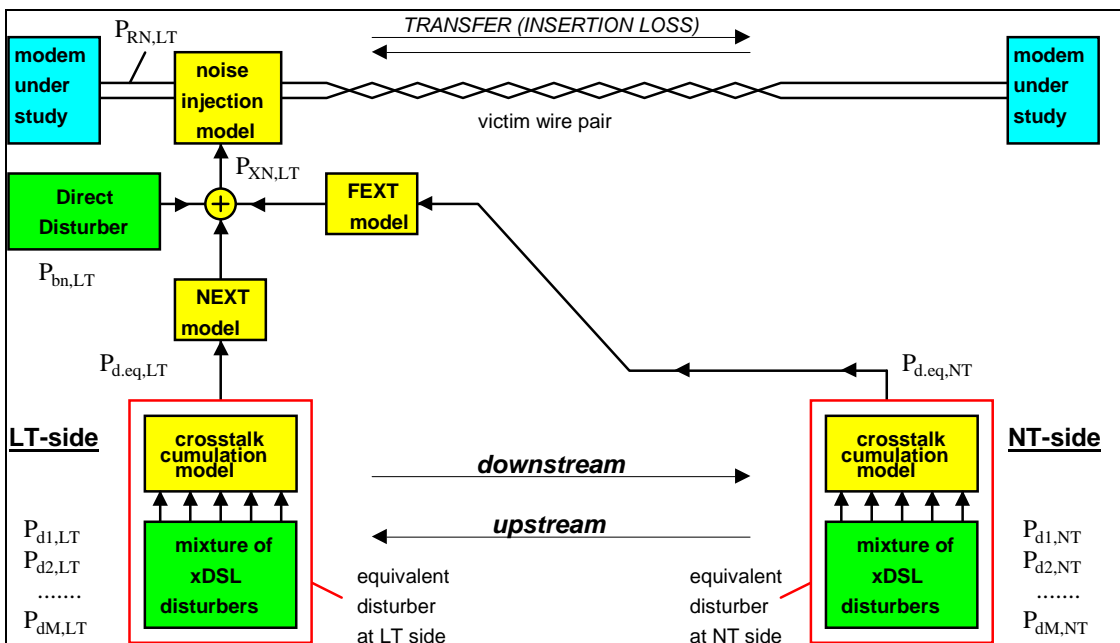

Figure 17: Flow diagram to evaluate the crosstalk probability limits for two-node topologies, at the LT side (for evaluating upstream performance)

9 Examples of evaluating various scenarios

This clause summarizes examples to show how the models in the present document can be used to perform spectral management studies.

9.1 European Spectral Platform 2004 (ESP/2004)

In 2004 several European operators created a simulation platform to support spectral management studies on e-SDSL and ADL-64. This platform comprises several (theoretical) scenarios to cover a wide range of situations being identified in European access networks. Each scenario is a compromise between computational convenience and computational complexity of real access networks. Nevertheless, the calculated performances of xDSL systems operating under these theoretical scenarios are assumed to be indicative for the minimum performance of these systems in various European situations.

The scenarios are a combination of a technology mix (to create a noise environment), system models, topology models and loop models.

9.1.1 Technology mixtures within ESP/2004

A distinct number of technology mixtures have been identified to enable a reasonable representation of scenarios that are being deployed in various European Networks. Their names are specified in table 69.

Table 69: Naming convention of used mixtures

Name	Description of the mix
	<i>High penetration mixtures</i>
HP/M	Mix includes both ADSL FDD flavours, SDSL, VDSL, HDSL.CAP/2 and HDSL.2B1Q/2
HP/R	Mix includes all four ADSL (FDD and FO) flavours, SDSL, VDSL and HDSL.CAP/2
	<i>Medium penetration mixtures</i>
MP/M	Mix includes both ADSL FDD flavours, SDSL, VDSL and HDSL.2B1Q/2
MP/P	Mix includes ADSL/POTS (FDD), SDSL, VDSL and HDSL.2B1Q/2
MP/I	Mix includes ADSL/ISDN (FDD), SDSL, VDSL and HDSL.2B1Q/2

The number of systems of each technology to be considered in each scenario is specified in table 70.

- For each reference scenario, the associated reference mix is specified in the columns labelled as "ref".
- For each modified scenario, the associated modified mix is specified in the columns labelled as "mod". The number of wire pairs occupied by the broadband systems remains the same as for the reference scenario.

By comparing the change in performance between both scenarios, the impact of replacing some "legacy" systems by systems of the new technology can be visualized. This concept is referred to as the "reference method".

NOTE 1: The victim system is not considered among the disturbers, i.e. it is subtracted from the total number of disturbing systems. For two-pairs HDSL systems, only one pair is considered as victim, whereas the other one is kept among the disturbers.

Table 70: Reference mixtures and modified mixtures with the new technology for the five scenarios

System	Mix	HP/M		HP/R		MP/M		MP/P		MP/I	
		Ref.	Mod.	Ref.	Mod.	Ref.	Mod.	Ref.	Mod.	Ref.	Mod.
SDSL 1 024 kb/s		5	5	16	16	4	4	4	4	4	4
SDSL 2 048 kb/s		10	10	16	16	5	5	5	5	5	5
HDSL 2B1Q/2		3x2	2x2	-	-	1x2	0x2	1x2	1x2	1x2	1x2
HDSL CAP/2		2x2	2x2	3x2	3x2	-	-	-	-	-	-
ADSL/POTS (FDD)		75	68	63	55	18	16	25	20	-	-
ADSL/ISDN (FDD)		25	22	96	84	7	6	-	-	25	20
ADSL/POTS (FO)		-	-	21	19	-	-	-	-	-	-
ADSL/ISDN (FO)		-	-	32	29	-	-	-	-	-	-
VDSL1 (FTTEx)		12 ¹⁾	12 ¹⁾	25 ²⁾	25 ²⁾	5 ¹⁾	5 ¹⁾	5 ¹⁾	5 ¹⁾	5 ³⁾	5 ³⁾
New system under study		0	12	0	25	0	5	0	5	0	5
ISDN.2B1Q (alone)		50	53	97	103	14	15	14	14	0	0
ISDN.2B1Q/filtered ⁶⁾		25 ⁴⁾	22	53 ⁴⁾	48 ⁴⁾	7 ⁴⁾	6 ⁴⁾	0	0	0	0
ISDN.MMS43 (alone)		0	0	0	0	0	0	0	0	14	19
ISDN.MMS43/filtered ⁶⁾		0	0	0	0	0	0	0	0	30 ⁵⁾	30 ⁵⁾
Pairs in total for BB		137	137	275	275	41	41	41	41	41	41
Pairs in total for BB and ISDN		187	190	372	378	55	56	55	55	55	60
NOTE 1: VDSL1 (FTTEx) P2 M2 with US0, ETSI main plan (997) or optional regional band plan (998).											
NOTE 2: VDSL1 (FTTEx) P2 M2 with US0, ETSI main plan (997) only.											
NOTE 3: VDSL1 (FTTEx) P1 M1 without US0, ETSI main plan (998) only.											
NOTE 4: These ISDN/2B1Q systems share the same pair with ADSL/ISDN systems.											
NOTE 5: These ISDN/MMS43 systems share the same pair with ADSL or VDSL over ISDN systems.											
NOTE 6: In case the victim modem shares the line with ISDN, reduce the number of filtered ISDN disturbers by one, and add a "Line shared ISDN" model to the line of that victim modem.											

NOTE 2: When VDSL1 is considered as disturbing system for the other systems it is not necessary to specify its band plan. When making simulations on VDSL1 performance instead, a homogeneous VDSL1 environment and the band plan indicated in the explanations of table 70 should be considered.

NOTE 3: The modified mixtures depend on the type of system under study. In this example the modified mixtures were determined for studies of ADL-64 and E-SDSL.

9.1.2 System models within ESP/2004

Table 71 specifies transmitter signal models for each system being part of the mix. Power back-off or power cut-back is taken into account for all the systems for which it is mandatory in the relevant specification. Concerning VDSL1 UPBO, use the reference PSD for Noise D (see TS 101 270-1 [i.11]) in high penetration scenarios (using HP/M and HP/R) and the one for Noise E in medium penetration scenarios (using MP/P, MP/I and MP/M).

Table 72 specifies receiver performance models for each system being part of the mix.

Table 71: Transmitter signal models

Name	Transmitter signal model
SDSL 1 024 kb/s	SDSL transmitter model, as specified in clause 4.10 for 1 024 kb/s
SDSL 2 048 kb/s	SDSL transmitter model, as specified in clause 4.10 for 2 048 kb/s
HDSL 2B1Q/2	HDSL transmitter model, as specified in clause 4.8 (use " default" model)
HDSL CAP/2	HDSL transmitter model, as specified in clause 4.9
ADSL/POTS (FDD)	ADSL transmitter model, as specified in clause 4.12 (<i>see note</i>)
ADSL/ISDN (FDD)	ADSL transmitter model, as specified in clause 4.14 (<i>see note</i>)
ADSL/POTS (FO)	ADSL transmitter model, as specified in clause 4.11
ADSL/ISDN (FO)	ADSL transmitter model, as specified in clause 4.13
VDSL1 (FTTEx)	VDSL1 transmitter model, as specified in clause 4.17
ISDN.2B1Q - alone	ISDN transmitter models, as specified in clause 4.2
ISDN.2B1Q/filtered	ISDN transmitter models, as specified in clause 4.3
ISDN.2B1Q - same pair	ISDN transmitter models, as specified in clause 4.4
ISDN.MMS43 - alone	ISDN transmitter models, as specified in clause 4.5
ISDN.MMS43/filtered	ISDN transmitter models, as specified in clause 4.6
ISDN.MMS43 - same pair	ISDN transmitter models, as specified in clause 4.4
NOTE:	Use the ADSL adjacent FDD template when ADSL is considered a disturber (in the noise), but use the ADSL guard band FDD template when ADSL is considered a victim.

Table 72: Receiver performance models

Name	Receiver performance model
SDSL	SDSL receiver model, as specified in clause 6.3
HDSL 2B1Q/2	HDSL receiver model, as specified in clause 6.1
HDSL CAP/2	HDSL receiver model, as specified in clause 6.2
ADSL/POTS (FDD)	ADSL receiver model, as specified in clause 6.5
ADSL/ISDN (FDD)	ADSL receiver model, as specified in clause 6.7
ADSL/POTS (FO)	ADSL receiver model, as specified in clause 6.4
ADSL/ISDN (FO)	ADSL receiver model, as specified in clause 6.6
VDSL1 (FTTEx)	<i>See note</i>
ISDN.2B1Q	<i>See note</i>
ISDN.MMS43	<i>See note</i>
NOTE:	The evaluation of the performance of this victim system is no part of ESP/2004; only broadband systems were investigated as victim system.

9.1.3 Topology models within ESP/2004

The scenario assumes that an uninterrupted homogeneous cable, without branches, interconnects the victim system under study. In addition, it assumes that the network topology can be represented by a simple (point-to-point) two-node topology model (see clause 8.6).

This is of course an over-simplification of real access networks, and therefore the way systems are disturbing each other is refined (a) according to the way NT systems are distributed along the cable, and (b) to what distance NT systems are separated from their LT counterpart.

Refinements of disturbance

For the first refinement, two different topologies are defined:

- **Distributed topology.** Here it is assumed that the NT ports of a cable (or bundle or binder group) are distributed along the loop, and that a single cable is capable of providing access to customers at both near and far distances from the exchange.
- **Virtually co-located topology.** Here it is assumed that the NT ports of a cable (or bundle or binder group) are virtually co-located, and that a single cable can only provide access to near locations or to far locations. Different cables are then needed to connect customers at both locations.

In either case, the LT disturbers are co-located with the LT victim. To compensate for the fact that some NT disturbers are not always at the same location as the NT victim system, the crosstalk of these disturbers is attenuated first.

Attenuated crosstalk means within this context the following: Assume that no disturber resides beyond the victim NT. If L is the distance between an investigated NT victim and a group of co-located NT disturbers, then calculate the crosstalk of these disturbers (NEXT & FEXT) at the location of these disturbers as if no other disturber does exist. In the following step, attenuate this noise level by the loss of a loop with length L . Repeat this for each group of co-located NT disturbers, and subsequently add the powers of all these crosstalk components to evaluate the crosstalk level at the location of the victims.

For the second refinement, the reach limits of the involved systems are accounting for the disturbance of such a system. This means that a system will not be deployed beyond its reach limits, and that the composition of the disturber mix changes when the loop length exceeds certain reach boundaries.

To simplify this refinement, only five reach boundaries are distinguished, and the involved systems are all classified according to these boundaries. This is summarized in table 73, and illustrated in figure 18.

Table 73: System classification according to the boundaries in figure 18

System class	System examples	Deployment practice
1	VDSL1	<i>VDSL1 will not be deployed beyond area 1 limit.</i>
2	SDSL, 2 048 kb/s	<i>2 048 kb/s SDSL will not be deployed beyond area 2 limits.</i>
3	HDSL/2	<i>Two-pair HDSL will not be deployed beyond area 3 limits, (except for "virtually co-located topologies" where the use of a regenerator is assumed to extent the reach).</i>
4	SDSL, 1 024 kb/s	<i>1 024 kb/s SDSL will not be deployed beyond area 4 limits. (except for "virtually co-located topologies" where the use of a regenerator is assumed to extent the reach).</i>
5	ADSL ISDN (SDSL, 512 kb/s)	<i>All these systems in the mix will be deployment up to area 5. (except for the "distributed topologies", that do not include 512 kb/s SDSL systems).</i>

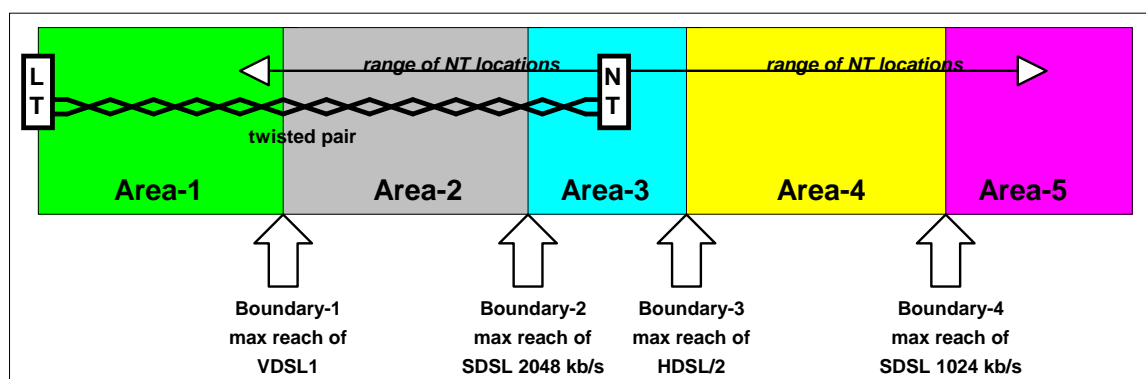

Figure 18: Concept of reach areas in ESP/2004, and associated boundaries

Boundary locations of the disturbers

The location of each boundary between two areas in figure 18 is scenario dependent, and is specified in table 74. Not all combinations of system mixtures and topology models are required for the ESP/2004 scenarios, and therefore table 74 is restricted to those combinations.

An example of the boundary values are summarized in table 74. These boundary values are assumed to be a fair reach estimation of the associated victim system, under the stress conditions of that particular scenario. Due to minor changes in the models, a reproduction of this table may not result in exactly the same numbers.

Table 74: Location of boundaries within the scenarios in ESP/2004

Scenario	Area bounds	Boundary 1 (Area 1-2)	Boundary 2 (Area 2-3)	Boundary 3 (Area 3-4)	Boundary 4 (Area 4-5)
HP/M (distributed)		1 500 m	2 440 m	2 880 m	3 520 m
HP/R (co-located)		1 500 m	2 140 m	2 960 m	3 210 m
MP/P (co-located)		1 500 m	2 820 m	3 260m	4 050 m
MP/P (distributed)		1 500 m	2 820 m	3 270 m	4 200 m
MP/I (distributed)		1 500 m	2 890 m	3 380 m	4 300 m
MP/M (distributed)		1 500 m	2 840 m	3 280 m	4 020 m

NOTE 1: The estimations in table 74 have been carried out in a certain order, and all these systems operated with at least 6 dB of noise margin. First a system was considered that has the shortest reach in the given scenario. Next the system was considered that has the second shortest range in the same scenario, and so on. In addition, the following simplifications have been applied:

- Boundary 1 is fixed to 1 500 m. (*This is the right-hand boundary of area 1, representing the maximum deployment distance of VDSL1.*)
- In scenarios where both HDSL.2B1Q/2 and HDSL.CAP/2 systems are present, boundary 3 represents the shortest reach of the two.

Handling disturbers in "distributed" topologies

Table 75 summarizes how to deal with the various disturbers in distributed topologies.

- Crosstalk from area 1 systems:** If a victim system is deployed beyond area 1, assume that VDSL1 is terminated at boundary 1. It disturbs the victim system by crosstalk, that couples over a reduced length as specified in clause 8.2.2.
- Crosstalk from area 2 systems:** If a victim system is deployed beyond area 2, assume that SDSL 2 048 kb/s is terminated at boundary 2. It disturbs the victim system by crosstalk, that couples over a reduced length as specified in clause 8.2.2.
- Crosstalk from area 3 systems:** If a victim system is deployed beyond area 3, assume that HDSL is terminated at boundary 3. It disturbs the victim system by crosstalk, that couples over a reduced length as specified in clause 8.2.2.
- Crosstalk from area 4 systems:** If a victim system is deployed beyond area 4, assume that SDSL 1 024 kb/s is regenerated and neglect the effect of the additional crosstalk by the repeaters somewhere between the LT and NT. However, the crosstalk that is generated by the SDSL 1 024 kb/s system at the end of the line should be taken into account.

Table 75: Summary of the disturbers to be considered in a distributed topology

Disturbers when victim NT is in				
Area 1	Area 2	Area 3	Area 4	Area 5
VDSL1	X-1	X-1	X-1	X-1
SDSL-2048	SDSL-2048	X-2	X-2	X-2
HDSL	HDSL	HDSL	X-3	X-3
SDSL-1024	SDSL-1024	SDSL-1024	SDSL-1024	Reg. SDSL-1024
ADSL	ADSL	ADSL	ADSL	ADSL
ISDN	ISDN	ISDN	ISDN	ISDN
Reg-SDSL-1024 means regenerated SDSL 1 024 kb/2 systems X-n means attenuated crosstalk from area-"n"				

Handling disturbers in "virtually co-located" topologies

Table 76 summarizes how to deal with the various disturbers in virtually co-located topologies.

- Crosstalk from area 1 systems:** If a victim system is deployed beyond area 1, assume that a disturbing VDSL1 is terminated at boundary 1 and disturbs the victim system by attenuated crosstalk.

NOTE 2: The concept of "virtual co-location" conflicts with the concept of attenuated VDSL1 crosstalk up to area 5, but the impact of such crosstalk becomes ignorable beyond some distance.

- **Crosstalk from area 2 systems:** If a victim system is deployed beyond area 2, convert the disturbing SDSL 2 048 kb/s into an SDSL system with lower bitrate. For victims deployed in area 3 or 4, this bitrate equals 1 024 kb/s. For victims deployed in area 5, this bitrate equals 512 kb/s.
- **Crosstalk from area 3 systems:** If a victim system is deployed beyond area 3, assume that HDSL is regenerated and neglect the effect of the additional crosstalk by the repeaters in the middle of the line. However, the crosstalk that is generated by the HDSL system at the end of the line should be taken into account.
- **Crosstalk from area 4 systems:** If a victim system is deployed beyond area 4, assume that a disturbing SDSL 1 024 kb/s is regenerated and neglect the effect of the additional crosstalk by the repeaters in the middle of the line. However, the crosstalk that is generated by the SDSL 1 024 kb/s systems at the end of the line should be taken into account.

Table 76: Summary of the disturbers to be considered in a virtually co-located topology

Disturbers when victim NT is in				
Area 1	Area 2	Area 3	Area 4	Area 5
VDSL1	X-1	X-1	X-1	X-1
SDSL-2048	SDSL-2048	SDSL-1024	SDSL-1024	SDSL-512
HDSL	HDSL	HDSL	Reg-HDSL	Reg-HDSL
SDSL-1024	SDSL-1024	SDSL-1024	SDSL-1024	SDSL-512
ADSL	ADSL	ADSL	ADSL	ADSL
ISDN	ISDN	ISDN	ISDN	ISDN

Reg-HDSL means regenerated-HDSL 2 pairs systems
SDSL-512 means a 512 kb/s SDSL system (or lower if that rate will not work either)
X-n means attenuated crosstalk from area-"n"

9.1.4 Loop models within ESP/2004

The models for transmission and crosstalk are specified in table 77. For the sake of simplicity, all effects related to the impedance for both the insertion loss and the crosstalk calculations are ignored. The impedance of 135 Ω is selected for all the systems, even if this is not correct for such systems like e.g. those belonging to the ADSL family.

Table 77: The involved models and associated parameters to account for various cable characteristics

Transmission	Two-port model	TP100	The TP100 cable model is described in annex A of the VDSL1 specification (TS 101 270-1 [i.11]). Bridge taps are assumed to be absent, and the characteristics of all cable sections in a cascade are assumed to be equal per unit length.
	Reference Impedance	$R_N = 135 \Omega$	The impact of the levels of signals, as a function of the termination impedance, is ignored for computational convenience. For calculating signal loss, assume that source and load impedance are $R_N = 135 \Omega$, for each xDSL system under study.
Crosstalk	Cumulation See clause 8.1		The FSAN sum for crosstalk cumulation, as specified in clause 8.1.2, applies for cumulating the power levels of M individual disturbers into the power level of an equivalent disturber.
	Coupling See clause 8.2	$K_{xn_dB} = -50 \text{ dB}$ $K_{xt_dB} = -45 \text{ dB}$ $f_0 = 1 \text{ MHz}$ $L_0 = 1 \text{ km}$	The basic models for NEXT and FEXT coupling in distributed cables, as specified in clause 8.2.2, apply for modelling crosstalk.
	Injection See clause 8.3	$H_{xi} \equiv 1$	The impact on the levels of crosstalk noise, as a function of the termination impedance, is ignored for computational convenience (equivalent to $H_{xi} \equiv 1$, see clause 8.3.1).

9.1.5 Scenarios within ESP/2004

To carry out a spectral management study for a "new system" under ESP/2004, the six scenarios in table 78 are to be evaluated according to the reference method. This means that the change in performance is to be evaluated for each broadband system in the mix of each scenario, when the mix changes from the "reference mix" to the "modified mix" (as specified before in table 70).

Table 78: The combination of mixtures and topologies that form the scenarios of ESP/2004

Scenario	Mix	Topology
1	HP/M	distributed
2	HP/R	co-located
3	MP/P	co-located
4	MP/P	distributed
5	MP/I	distributed
6	MP/M	distributed

In addition, the following applies:

- All the systems have at least 6 dB of noise margin.
- The frequency resolution to be used in the simulations is 4,3125 kHz or smaller.
- A flat level of -140 dBm/Hz representative of background noise is added to the overall crosstalk noise.

Annex A: Bibliography

- ETSI-TM6(97)02: "Cable reference models for simulating metallic access networks", R.F.M. van den Brink, ETSI-TM6, Permanent document TM6(97)02, revision 3, Luleå, Sweden, June 1998 (970p02r3).

History

Document history		
V1.1.1	October 2005	Publication
V1.2.1	July 2008	Publication